

desking

workstations, tables, storage, screens and accessories

SPECIFICATION GUIDE - AUG 2024

Contents

Portfolio Overview



Progress Plus - 15



Progress - 25



Progress Lite - 34



Linnea Elevate - 36



Lux - 42



Reflex - 52



Linnea - 57



Matrix+ - 72



Kassini - 85



Optima Plus - 92



Callisto - 103



Windsor - 109



Flexi - 115



Desk Extensions - 120



Call Centre - 122



Interact - 127



Reception - 131



Conference / Meeting - 142



Alto Canopy - 173



Alto Benches - 177



Harmony Benches - 179



Loco Benches - 180



Cubeform Benches - 183



Lux Benches - 185

Contents

Portfolio Overview



Forte Benches - 187



Tilt Tables - 190



Fliptop Tables - 191



Folding Tables - 192



Training Tables - 192



Meeting Tables - 197



Bar Tables - 201



Coffee Tables - 203



Switch - 210



Computer / Laptop Tables - 211



Mobile Whiteboard - 212



Pedestals and Personal Storage - 214



Storage - 224



Steel Storage - 235



Cubeform - 238



Recycling Units - 255



Modular Lockers - 256



Desk Mounted Screens - 264



Floor Standing Screens - 273



Oases Screens - 278



Accessories - 290



Power Modules - 294



Monitor Arms - 305



Lighting - 309

Contents

Portfolio Overview

	Page		Page
Elite Office Furniture	4	Storage	224
Standards	5	Flare and Combined Storage	225
Services	6	Desk High and Desk Top Storage	227
Ergonomics	7	Planter Units	229
Finishes	8	Desk High and Tall Storage	230
Fabric Bandings	12	Steel Storage	235
		Cubeform	238
Progress Plus - Height Adjustable	15	Recycling Units	255
Progress - Fixed and Height Adjustable	25	Modular Lockers	256
Progress Lite - Height Adjustable	34	HotBox	263
Linnea Elevate - Fixed	37		
Lux - Fixed	42	Desk Mounted Screens	264
Reflex - Fixed	52	Floor Standing Screens	273
Linnea - Fixed	57	Oases - Agile Working Solutions	278
Matrix+ - Fixed	72	Hive Floor Standing Screens	287
Kassini - Height Adjustable and Fixed	85	Park Floor Standing Acoustic Screens	288
Optima Plus - Height Adjustable and Fixed	92	Hush Wall Mounted Acoustic Panels	289
Callisto - Fixed	103		
Windsor - Fixed	109	Accessories	290
Flexi - Fixed	115	Go Bright	291
Desk Extensions	120	Slat Wall / Screen Mounted Accessories	293
		Power Modules	294
Call Centre	122	Kaspa	294
Interact Collaborative Tables	127	Prime	294
Reception	131	Boardroom	295
Conference / Meeting Tables	142	Conus	296
		Peak	297
Benches	172	Escalate	297
Alto Canopy	173	Wireless Charging Unit	298
Alto	177	Port Hole	299
Harmony	179	Pix	299
Loco	180	Pluto	300
Cubeform	183	Inca	300
Lux	185	Flex	301
Forte	187	Boost	301
		Capsule	302
Modular Tables	189	Plaza	303
Tilt	190	Wieland	303
Fliptop	191	Power Accessories	304
Folding	192	Monitor Arms	305
Training	192	Flex	305
Vista	194	Maya	306
Piazza	195	Ascend	307
Tondo	196	Flo	307
Meeting	197	M2	308
Bar	201	M8	308
Coffee	203	Ollin	308
Computer / Laptop	210	Lighting	309
Mobile Whiteboard	212	Supa	309
		Mini Z-Bar	309
Pedestals and Personal Storage	214	Various	310
Mobile Pedestals	215		
Steel Pedestals	217	Accessory Compatibility Breakdown	311
Desk High Pedestals	218	Dimensions and Notes	316
Personal Storage	220	Terms and Conditions	319
Handles	222		

Elite Office Furniture

Contact Information and Our Introduction



Head Office, Showroom and Factory

Elite Road
Goole
East Yorkshire
DN14 8BF

t: +44 (0)1405 746000

email: sales@elite-furniture.co.uk
www.elite-furniture.co.uk



London Office and Showroom

81-87 St John Street
Clerkenwell
London
EC1M 4NQ

t: +44 (0)20 7490 4909

email: londonshowroom@elite-furniture.co.uk

Proudly Manufactured in Great Britain



Our History

In 1986, Elite Office Furniture began production in Howden, East Yorkshire. Two years later production moved to larger premises in Goole, East Yorkshire with a workforce of 12.

The business has seen progressive growth over the last 35 years, now standing as a multi-million-pound business, occupying 244,254 sq ft of manufacturing space and employing 150 people.

Our people are at the heart of everything we do, with the current workforce still bearing the original staff and factory operatives that started with the company all them years ago.

Our Future

Strategic decisions being made now are pathing the way for further success at Elite.

Our new manufacturing facility sustains future production and allows us to develop within the industry, not only as a major competitor, but one with strong credentials to minimising the effect of manufacturing on the environment.

Because of our investment, we believe the future at Elite going to be exciting, a journey we want you to be a part of.

Standards

Furniture, Acoustic Screen, Dividing Screen and Seating Accreditations



Furniture Accreditations

- BS EN 527-1:2011
Office furniture desking dimensions.
- BS EN 527-2:2002
Office furniture desking mechanical safety requirements.
- BS EN 527-3:2003
Office furniture desking strength and stability.
- BS EN ISO 9241-5:1999
Ergonomics of VDU/TFT screen usage within offices.
- BS 4875-7:2006
Strength and stability of shelving.
Test level 4 (shelves only).
- BS 6396:2008 + A1:2015
Office furniture desking electrical systems.
- BS EN 13722:2004
Gloss/reflective level testing on furniture surfaces.
- BS EN 14073-2:2004
Strength and rigidity testing of storage furniture part 2.
- BS EN 14073-3:2004
Strength and rigidity testing of storage furniture part 3.
- BS EN 14074:2004
Endurance and stability testing of storage furniture.
- BS EN 15372:2008 level 2
Standard and folding tables structurally suitable and stable for general contract use.
- BS EN 14323:2004
Dual Board resistance to scratching, cracking and staining.

Acoustic Screen Accreditations

- BS EN ISO 354:2003
Measurement of sound absorption in a reverberation room.
- ISO 11654:1997
Sound absorbers for use in buildings - Rating of sound absorption.
- ISO 9613-2:1996
Attenuation of sound during propagation outdoors.
- ISO 9613-1:1993
Calculation of the absorption of sound by the atmosphere.
- BS EN 12667:2001
Thermal Conductivity / Resistance Performance.
- BS EN 13501-1:2007 +A1:2009
Fire Classification Of Construction Products Building Elements.
- BS EN 13823:2010 + A1:2014
Reaction to Fire Tests. Thermal attack by single burning item.
- BS EN ISO 11925-2:2010
Reaction to Fire Tests. Ignitability of building products subjected to direct impregnation of flame - part 2 Single-flame source test.

Dividing Screen Accreditations

- BS 476-7:1987
Flammability test for Screens (Class 2).
- BS EN 1023-1:1997
Office furniture screens, dimensions.
- BS EN 1023-2:2000
Office furniture screens, mechanical safety requirements.
- BS EN 1023-3:2000
Office furniture screens, test methods.

Seating Accreditations

- BS EN 1022:2005
Seating, determination of stability.
- BS EN 1335-1 + BS EN 1335-2 + BS EN 1335-3
Office work chairs safety test methods.
- BS EN 1728:2012 + AC:2013
Seat and Back Static Load Test and Durability.
Front and Back Fatigue Test and Impact Test.
- BS EN 5459-2: 2000+A2:2008
Office seating for use by person weighing up to 150kg and for use up-to 24 hours a day.
- BS EN 13761:2002
Visitor Chairs - Dimensions and Safety Requirements.
- BS EN 15373:2007 level 2
Seating strength, durability and safety.
Requirements for non-domestic seating.
- BS EN 16139:2013
4 Legged and cantilever seating, strength, durability and safety requirements.
- BS EN 10025:1993
Specification for hot rolled products of non-alloy structural steels and their technical delivery conditions.
Applicable to all chrome plated parts.
- ANSI/BIFMA X5.1-2011
International testing certificate for office chairs.
Sections:05,11.3,13,14 and 15.
- TUV Eco-Circle 2008
Tested for recyclable content, harmful substances, energy saving and ergonomic design.
- NEOCON
Silver Award Winner 2013 Chicago, USA.

Services

Design Services and Chair in a Box

Design Services

At the heart of Elite lies our design and marketing department that over twenty years has grown from one to seven members. The workplace is continuously evolving, with new concepts and studies shaping the way we design the environment. Our most effective way of maintaining focus on current workplace trends is through attendance at trade shows and exhibitions where we have the opportunity to meet designers and industry influencers who are selected as key-speakers, often covering pressing industry topics.

The design team delivers a breadth of varied services from 2D spacial planning to realistic 3D computer generated visuals. Whether space permits large volumes of staffing or space is an issue, the team will offer successful and practical solutions that take advantage of the available space.

Each project is carefully analysed to achieve the very best layout and conformability to your requirements, complying to current health and safety laws and guidelines. 3D design is now a well-established practice in office design and provides the best method of illustrating office layout designs. We are working to industry standard BIM level 2, that involves developing building information in a collaborative 3D environment with data attached.

For your convenience, all available CAD and Revit Blocks, Product Thumbnails and Assembly Instructions are available at: <https://www.elite-furniture.co.uk/project/downloads/>



Chair in a Box

Elite offer two different 'boxed' seating delivery options. Delivery cost is dependant on the option you choose, please see below the two options that are available including the code required for when placing your order. For compatibility, please look for the following icon next to your chosen chair. 

Option 1: Elite Delivery

Chairs boxed at the factory and delivered using the standard Elite transport method to your registered (regular) warehouse address. Delivery based on weekday multi drop vehicles / untimed delivery.

The cost for this option is **per chair**.

When ordering please suffix the chair code with **.../BOX1**.

Option 2: Courier Delivery

Chairs boxed and shipped using a courier service to your requested UK mainland address. In these instances where speed and convenience is of the essence, chairs can be dispatched within 24 hours post manufacture. No guarantee can be made regarding the exact time of delivery. 9am - 5pm is standard.

Chairs delivered by courier are dispatched in a box 1000mm high (maximum). Please expect some models to be delivered in KD format in order to comply with the couriers tolerance height for shipping. In these instances it may be the case that minimal assembly is required on arrival.

The cost for courier delivery is **per chair**.

Delivery time is 24-48 hours upon collection by the courier.

When ordering please suffix the chair code with **.../BOX2**.



Ergonomics

Overview and Guidelines

Ergonomics Overview

Ergonomics is an applied science that aims to understand people physically and psychologically, in order to design and arrange products, environments and processes for human interaction in the most safe and efficient ways.

Sitting with the correct posture is crucial for maintaining good health, allowing bones and joints to align, decreasing the abnormal wearing of joints that could cause joint pain or even degenerative arthritis. It also reduces stress on the ligaments holding spinal joints together, minimizing the likelihood of injury. There are increasing reports of musculoskeletal disorders caused by poor workstation set ups, poor posture, repetitive movements, intensive work and infrequent breaks.

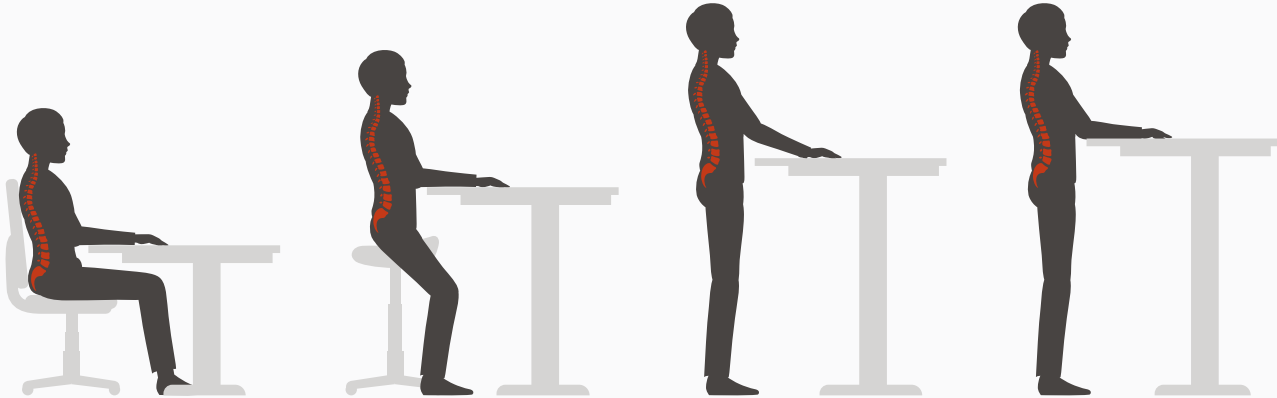

A good posture allows muscles to work more efficiently, allowing the body to use less energy and therefore, preventing muscle fatigue. It helps prevent muscle strain, overuse disorders and even back and muscular pain. Taking care of your posture will maximise comfort, safety and performance, allowing you to focus on what's important.

Chairs that have given consideration for ergonomics have a multitude of advantages. As well as correctly supporting the users posture, they provide supreme comfort with headrests, preventing neck problems and the inclusion of a cushioned seat pad as opposed to a hard seat reduces the pressure on the hips.

The diagram below illustrates the recommended natural posture, demonstrating less stress on the body, reducing the chances of harm and injury to the individual. The ergonomic chair ensures appropriate alignment of the body including the eyes, head, neck, shoulders, arms, back, knees and feet all in relation to the desk and computer screen.

Posture Guidelines

- 1 Maintain a distance between eyes and screen of 500mm to 700mm.
- 2 Keep your shoulders relaxed and not raised.
- 3 Keep your forearms horizontal and elbows bent at an angle slightly in excess of 90°.
- 4 Maintain a distance between knees and desk of 80 to 100mm.
- 5 Avoid pressure to the area behind the knees.
- 6 Keep your legs bent at an angle of between 90° to 120°.
- 7 Keep your feet resting on the floor.
- 8 Let the backrest support your back.
- 9 Sit firmly against the back with a small gap between the front of the seat pad and the back of your knees.

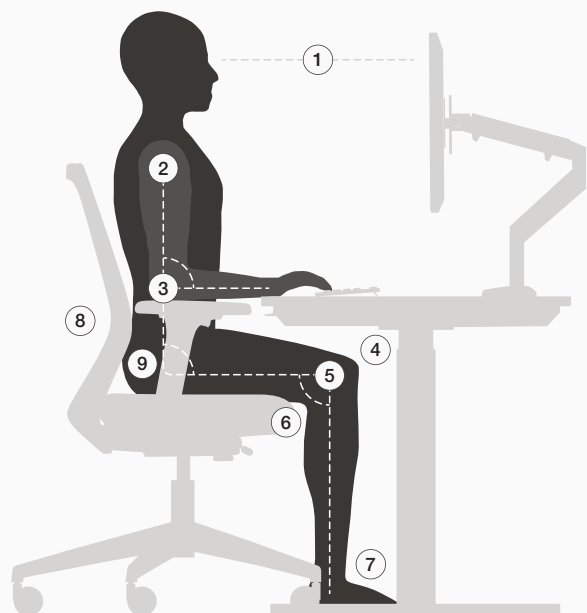

Finishes

Dual Board MFC, Nanotech, Edging and Veneer

Standard Dual Board MFC Finishes

- The 10 finishes below are our standard 25mm and 18mm MFC finishes.
- An MFC finish needs to be specified when ordering an MFC product.



Ash



Autumn Cherry



Beech



Chester Oak



English Walnut



Grey



Grey Nebraska Oak



Laurentii Wenge



Natural Nebraska Oak



White

Standard Nanotech Finishes

- The finish below is our Nanotech finish and is subject to a 2 week lead time.
- Undercut edging detail option available.
- Contact Customer Services for specification, prices and lead time.



Black Matt MDF

Standard Contrasting Edging Options for White Dual Board MFC and Nanotech Finishes

- The 3 finishes below are standard edging options for 25mm White Dual Board MFC and Nanotech finishes only.
- Colourmatched edging will be applied if an edging finish has not been specified when ordering an MFC or Nanotech product.
- On White Dual Board MFC products, Add surcharge per top for Black, Laurentii Wenge or Plywood Effect edging.
- On Nanotech products, Black, Laurentii Wenge and Plywood Effect edging.



Black
with White
Add surcharge per top



Laurentii Wenge
with White
Add surcharge per top



Plywood Effect
with White
Add surcharge per top

Standard Veneer Finishes

- The 2 finishes below are our standard 25mm and 18mm Veneer finishes.
- Elite cannot guarantee continuity in the appearance of veneer panels.
- Elite process pre-veneered boards that cannot be book or colour matched.



Oak



Walnut

Whilst every effort has been made to ensure accurate colours are illustrated in this document, there may be a slight colour difference due to the printing process, therefore please refer to our colour sample swatches prior to ordering.

Finishes

Solid Wood, Coloured MFC and Wooden Frame Finishes

Solid Wood Finishes

- The finish below is a non-standard 32mm Solid Wood finish that can be specified on Alto, Harmony and Loco Benches only.
- Finish supplied with square edging only.
- This material is natural and its appearance will vary including grain patterns and burring / knots in the surface.
- Subject to a 3 week lead time, see individual product pages for specification and pricing.



Oak (32mm)

Coloured MFC Finishes

- The 7 finishes below are non-standard 18mm MFC finishes that can be specified on select items only.
- Matching edging tape.
- Subject to a 2 week lead time, see individual product pages for further specification and pricing.



Praline



Olive Green



Atlantic Blue



Sapphire Blue

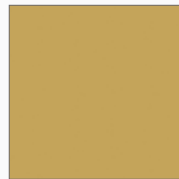

Mustard Yellow

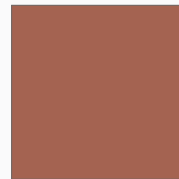

Terracotta



Conker Brown

Wooden Frame Finishes

- One of the 2 finishes (top) below are available as standard on ranges where wooden frames are specified, see individual product pages for specification and pricing.
- The 6 finishes (bottom) below are available on ranges where wooden frames are specified, see individual product pages for specification and pricing.
- Due to the staining process and the use of natural materials, no guarantee can be given to the final appearance and continuity when staining timber products.
- See individual product pages for specification and pricing.



Ash

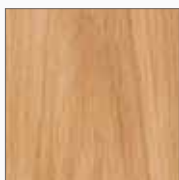

Beech

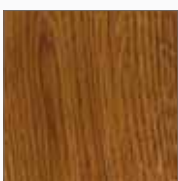

Stained Walnut



Stained Espresso

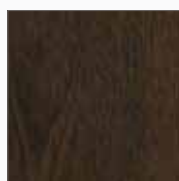

Stained Wenge



Stained Black

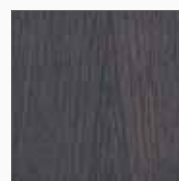

Stained Grey



White

Whilst every effort has been made to ensure accurate colours are illustrated in this document, there may be a slight colour difference due to the printing process, therefore please refer to our colour sample swatches prior to ordering.

Finishes

Metalwork and Acrylic Finishes

Standard Metalwork Finishes

- The 3 finishes below are our standard Metalwork finishes.



Elite Silver
RAL 9006



Black Graphite
RAL 9004



White
RAL 9003

Item Specific Metalwork Finishes

- The 10 finishes below are non-standard Metalwork finishes which can be specified where indicated.
- Add specified price or add surcharge to retail price for Chrome Effect, Raw and Black finish.
- Add specified price or add surcharge to retail price for Praline, Olive Green, Atlantic Blue, Sapphire Blue, Mustard Yellow, Terracotta and Conker Brown finishes and is subject to a 2 week lead time.
- See individual product pages for further specification and pricing.



Chrome Effect
Add surcharge on
non-Seating Products



Raw
Add surcharge on
non-Seating Products



Black
RAL 9005
Add surcharge

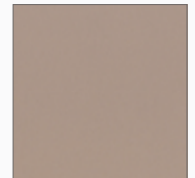

Praline
Add surcharge on
non-Seating Products



Olive Green
Add surcharge on
non-Seating Products



Atlantic Blue
Add surcharge on
non-Seating Products



Sapphire Blue
Add surcharge on
non-Seating Products

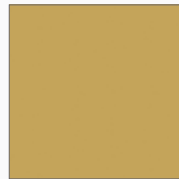

Mustard Yellow
Add surcharge on
non-Seating Products

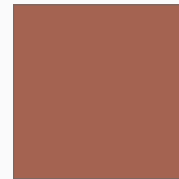

Terracotta
Add surcharge on
non-Seating Products



Conker Brown
Add surcharge on
non-Seating Products

Acrylic Finishes

- The 6 finishes below are available on our Acrylic Screens.
- All Hygiene Protection Screens are available in Clear Acrylic only.

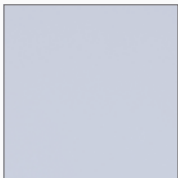

Blue

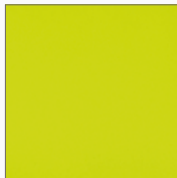

Green



Orange



Red

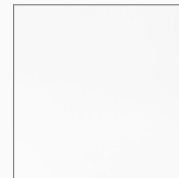

Frosted

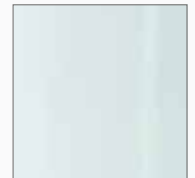

Clear

Whilst every effort has been made to ensure accurate colours are illustrated in this document, there may be a slight colour difference due to the printing process, therefore please refer to our colour sample swatches prior to ordering.

Finishes

Dual Board MFC and Acoustic Screens Breakdown

Dual Board MFC

Elite are an exclusive user of the superior quality melamine board called 'Dual Board'. The board consists of a chipboard core surfaced on both sides by a sheet of MDF. The newly developed 'Dual Board' material offers significant advantages including structural, machining and component strength.

The material offers Elite's client increased quality and added value. It offers greater impact resistance combining the durability of MDF and Chipboard into a single board.

The MDF faces of 'Dual Board' eliminates any irregularities associated with raw chipboard and translates this into a smooth, even surface. For our highly complex production operation this level of board performance is essential and translates directly into the high standards of quality offered to Elite clients.

Accreditations

BS EN 13722:2004

Attributes

Perfect cutting during manufacture. High physical-mechanical performance, providing excellent response in demanding load situations. High resistance to impact, preventing marks, deformities or surface damage. The properties of the exterior high-density fibre layer reduce surface absorption.



Acoustic Screens (Class B)

Flexible working environments are continuing to become essential in the workplace, with a requirement to accommodate a broad range of users. Removing walls as active barriers and opting for open plan offices and furniture layouts, utilises the building footprint and delivers modular furniture to support agile working techniques. With the higher number of employees using the same space, the noise within a closer proximity increases.

Research suggests that one of the biggest contributing factors of workplace unrest is inadequate acoustics and consideration must be given to employees working in congested environments to support their productivity. Investing in acoustic screen solutions will increase efficiency and employee morale, demonstrating a considerate approach to individual's wellbeing.

Accreditations

ISO 354:2003, ISO 11654:1997, ISO 9613-1:1993, EN 12667:2001, EN 13501-1:2007 +A1:2009, EN 13823:2010 and ISO 11925-2:2010

Acoustic Certification - Achieved class B - 0.85(H)
Sound Absorption - GB/T20247-2006/ISO354:2003 (A Level)
Environmental - GB/T5849-2006 (E0 Level)
Fire Retardant - GB 862402006 and
GEN 13501-1:2007+A1:2009 (B Levels)

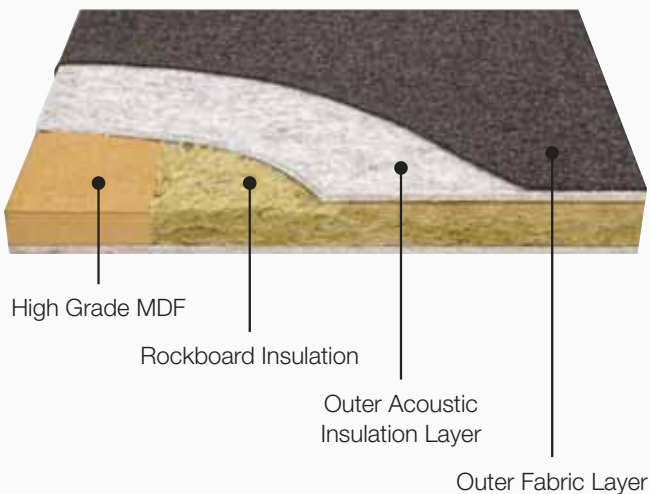

Finishes

Fabric Bandings Groups 1-4

Group 1

Abbotsford Classic Plain (€+) (👤)
Abbotsford Classic Herringbone (€+) (👤)
Agua Chea (€+) (👤)
Agua Task (€+) (👤)
Camira Advantage (👤) (👤)
Camira Citadel (👤)
Camira Era (👤)
Camira Gravity (👤)
Camira Phoenix (👤)
Camira Rivet (👤)
Camira Xtreme (👤)
Gabriel Chilli (👤) (👤)
Gabriel Fighter (👤)
Gabriel Noma (👤)
Gabriel Tonal (👤)
Inloom Alba
Inloom Bondai
Inloom Radio
Panaz Highland (👤)
Panaz Marna
Panaz Noble
Chieftain Just Colour (Vinyl) (👤)
Chieftain Just Patterns (Vinyl) (👤)
Chieftain Trimcell Classic (Vinyl) (👤)
Chieftain Trimcell Legend (Vinyl) (👤)
Panaz Cadet (All) (Vinyl) (👤)
Yarwood Dollaro (Vinyl) (👤) (€+)

Group 2

Agua Hana (👤) (€+)
Agua Lavoro (👤) (€+)
Agua Libra (👤) (€+)
Agua Vina (👤) (€+)
Camira Aspect (👤) (👤)
Camira Chateau (👤)
Camira Main Line Plus (👤) (👤)
Camira Quest (👤) (👤)
Camira Replay (👤) (👤)
Camira Sprint (👤)
Camira Urban (👤) (👤)
Camira X2 (👤)
Gabriel Atlantic
Gabriel Blend (👤)
Gabriel Cura (👤)
Gabriel Go Check (👤) (👤)
Gabriel Go Couture (👤)
Gabriel Go Uni (👤)
Gabriel Medley (👤)
Gabriel Renewed Loop (👤)
Gabriel Step (👤) (👤)
Gabriel Step Melange (👤) (👤)
Inloom King Flex
Inloom One
Inloom Time (👤)
Panaz Alba
Panaz Eve (👤)
Panaz Harvard (👤)
Panaz Highland Stretch (Matte) (👤)
Panaz Microvelle
Panaz Montagu (👤)
Panaz Riva
Agua Paint Pot (Vinyl) (👤) (€+)
Camira Vita (Vinyl) (👤) (👤)
Panaz Aston (Vinyl) (👤)
Panaz Brookland (Vinyl) (👤)
Panaz Morgan Pro (Vinyl) (👤)
Panaz Soft Touch Pro (Vinyl) (👤)
Panaz Vintage (Vinyl)
Spradling Mardi Gras (Vinyl) (👤) (€+)
Spradling Tannery (Vinyl) (€+)
Spradling Valencia C5 (Vinyl) (👤) (€+)

Group 3

Agua Buro (👤) (€+)
Agua Eden (€+) (👤)
Agua Linetta (€+) (👤)
Agua Primeira (👤) (€+)
Camira Main Line Flax (👤) (👤)
Camira Nexus (👤)
Camira Penta (👤)
Camira Sumi (👤) (👤)
Camira Synergy (👤) (👤)
Gabriel Athlon (👤)
Gabriel Connect (👤) (👤)
Gabriel Contour
Gabriel Cyber (👤)
Gabriel Felicity
Gabriel Focus (👤) (👤)
Gabriel Focus Melange (👤) (👤)
Gabriel Grain (👤) (👤)
Gabriel Lense (👤)
Gabriel Mica
Gabriel Swing (👤)
Inloom Jeans (👤)
Inloom Jet
Inloom Milano (👤)
Inloom Respun
Inloom Riva
Inloom Roccia (👤)
Panaz Altair (👤)
Panaz Coco
Panaz Kilda
Panaz Linear (👤)
Panaz Luxe Performance Velvet
Svensson Ally (👤)
Svensson Easy
Svensson Hello RE
Svensson Macro
Svensson Semi (👤)
Svensson Tone
Vescom Acton (€+) (👤)
Vescom Samar (👤) (€+)
Agua Entwine (Vinyl) (€+) (👤)
Agua Fleck (Vinyl) (€+) (👤)
Agua Lunar (Vinyl) (👤) (€+)
Agua Taurus (Vinyl) (👤) (€+)
Chieftain Pasha (Vinyl) (👤)
Panaz Vyflex Plus (Vinyl) (👤)
Spradling Maglia C5 (Vinyl) (👤) (€+)
Spradling Silvertex C5 (Vinyl) (👤) (€+)
Spradling Valencia C5 Heritage (Vinyl) (👤) (€+)
Yarwood Churchill (Vinyl) (👤) (€+)



Group 4



Abbotsford Classic Melton (👤) (€+)
Agua Boucle (👤) (€+)
Agua VerdEco (👤) (€+)
Agua Zephyr (👤) (€+)
Camira 24/7+ (👤)
Camira 24/7 Flax (👤) (👤)
Camira Aquarius (👤) (👤)
Camira Blazer (👤) (👤)
Camira Halcyon Aspen (👤)
Camira Halcyon Blossom (👤)
Camira Halcyon Cedar (👤) (👤)
Camira Hemp (👤) (👤)
Camira Hi-Tech (👤)
Camira Intervene Texture (👤) (👤)
Camira Kyoto (👤) (👤)
Camira Main Line Twist (👤) (👤)
Camira Oceanic (👤) (👤)
Camira Track (👤) (👤)
Chieftain Carousel (👤)
Chieftain Ravel (👤)
Gabriel Beyond Loop (👤) (👤)
Gabriel Bond (👤) (👤)
Gabriel Breeze Fusion (👤) (👤)
Gabriel Capture (👤)
Gabriel Crisp (👤) (👤)
Gabriel Europost 2 (👤)
Gabriel Fame (👤)
Gabriel Gaja Classic (👤)
Gabriel Just
Gabriel Mood (👤)
Gabriel Select (👤)
Gabriel Tempt (👤)
Inloom Nautilus (👤)
Inloom Sealife
Panaz Allure
Panaz Shelby
Vescom Aukland (€+) (👤)
Vescom Bowen (€+) (👤)
Vescom Burton (€+) (👤)
Vescom Harding (👤) (€+)
Vescom Lindau (👤) (€+)
Agua Oregon Hyde (Vinyl) (👤) (€+)
Chieftain Lionella (Vinyl) (👤)
Chieftain Multistretch (Vinyl) (👤)
Spradling Chronos (Vinyl) (👤) (€+)
Yarwood Colorado (Vinyl) (👤) (€+)
Yarwood Vintage (Vinyl) (👤) (€+)



Finishes



Fabric Bandings Groups 5-7 and Leather



Group 5

Agua Cord   £+



Agua Pearl   £+



Camira Regent Velvet   

Camira Silk  

Camira Yoredale  

Chieftain Earthly

Gabriel Focus Royal  

Gabriel Morph  

Gabriel Passion 



Inloom Corte 



Inloom Spazio

Svensson Khaki 



Svensson Node 



Vescom Foster  £+

Camira Deca (Vinyl)  

Spradling Artesian (Vinyl)   £+

Group 6

Bute Mercury   £+

Camira Craggan Flax  

Camira Patternmaker 

Gabriel UMBER 

Svensson Cody 

Svensson Harper 



Svensson Heritage 



Svensson Step



Vescom Moore  £+



Chieftain Protect 7 (Vinyl)



Group 7



Bute Elgin   £+



Bute Identity Clan   £+

Bute Identity Kin   £+

Bute Magic   £+

Bute Strata Mason   £+

Bute Strata Mineral   £+

Camira Revolution  

Camira Synergy Quilt Channel 

Camira Synergy Quilt Chevron 



Camira Synergy Quilt Hourglass 



Gabriel Comfort + 



Gabriel Cubic 



Gabriel Nobel 

Inloom Nabucco 



Kvadrat Clara 2   £+



Kvadrat Field 2   £+

Kvadrat Floyd   £+

Kvadrat Reflect   £+

Kvadrat Relate  £+

Kvadrat Remix 3   £+

Kvadrat Steelcut Trio 3   £+

Svensson Accessoire 

Svensson Balance 



Svensson Club 

Svensson Debut 

Svensson Ink 

Svensson Mingel

Svensson Poppy 

Camira Layer (Vinyl)  

Leather

Crest Shelly   £+

Yarwood Style   £+



Finishes

Screen Fabric Bandings Groups 1-7 and Oases Fabric Bandings Groups A-C







Screen Group 1

Camira Cara 
Camira Carlow 
Camira Era 170 
Camira Lucia 
Camira Sonus 
Gabriel Tonal 170 



Screen Group 2

Camira Lucia CS Screen 
Gabriel Event Screen Plus 



Screen Group 3

Camira Blazer Lite 
Camira Nexus 
Gabriel Mica 170 
Gabriel Renewed Loop Screen 
Gabriel Twist 
Gabriel Twist Melange 

Screen Group 4

Camira Synergy 170 
Gabriel Atlantic Screen 170 
Gabriel Just 170 







Screen Group 5

Gabriel Focus Melange Screen 
Gabriel Step Screen 
Gabriel Step Melange Screen 

Screen Group 6

Gabriel Hush Flair 





Screen Group 7

Kvadrat Floyd Screen 170  
Kvadrat Hint 170  
Kvadrat Relate Screen 170  



Oases Group A

Camira Era 170 
Camira Lucia CS Screen 
Gabriel Cura 
Gabriel Lamina 
Gabriel Tonal 170 

Oases Group B

Camira Blazer Lite 
Camira Nexus 
Camira Sprint 
Camira Synergy 
Gabriel Twist 
Gabriel Twist Melange 

Oases Group C

Camira Blazer 
Gabriel Atlantic Screen 170 
Gabriel Focus Melange Screen 

Recommended for our soft seating ranges 

Recommended for our screen / panel ranges only 

Recommended for our Oases range 

Fabrics available for products on a one-week lead time - Please note, UK stocked colourways only - Please check before ordering 

Surcharge Applicable 

* Please note, when ordering less than 10 units in any Abbotsford, Agua, Bute, Spradling or Yarwood fabric, the order will be subject to a surcharge

* Please note, when ordering less than 10 units in any Crest fabric, the order will be subject to a surcharge

* Please note, when ordering less than 15 units in any Kvadrat fabric, the order will be subject to a surcharge

* Please note, when ordering less than 15 units in any Vescom fabric, the order will be subject to a surcharge

When multiple fabric band selections are specified, the unit price will reflect the highest band fabric requested

Progress Plus

Electric Sit / Stand Workstations, Meeting and Screens



With its clean lines and lightweight design, Progress Plus has been designed to blend into the modern office environment. Its electric height adjustment enables a smooth transition between sitting and standing, allowing users to vary their posture throughout the day. Progress Plus features an optional control panel that is operated using Bluetooth® technology between the desk and an advanced mobile app, aimed at developing a healthy routine into the workday. The panel tracks the usage of the desk, reminding users to adjust their station, changing the users prolonged sitting behaviour. Within the frame, there is an innovative wire management tray that conceals cables and is easily accessed using two folding hoods. To further personalise the desk, there are a number of optional accessories to complement the range.



Progress Plus

Height Adjustable Workstations

3 Week Lead Time

MFC:	Available in Ash, Autumn Cherry, Beech, Chester Oak, English Walnut, Grey, Grey Nebraska Oak, Laurentii Wenge, Natural Nebraska Oak and White
Veneer:	Available in Oak and Walnut (3 Week Lead Time)
Edging:	Add surcharge for Wenge, Black and Plywood Effect per top - Edging on 25mm White MFC only
Metalwork:	Silver, Black Graphite and White



PP16/16/EHA

Progress Plus Electric Height Adjustable Double Bench

- 3 week lead time.
 - 2x 25mm sliding top panels.
 - Complete with 2x horizontal cable trays.
 - Sit / stand height adjustment of 650mm-1280mm via electronic up / down keypad.
 - Anti-collision as standard.
 - Pedestals 640h and over will clash with the subframe when in the lowest height setting.
- An Advanced Keypad can be specified to enable a minimum height setting to be configured preventing surface contact (page 17). The recommended pedestal for the standard keypad is an MPF, MP3, MPFM or MP3M (page 215).

- PP18/16/EHA** - 1800w x 1600d x 650-1280h
- PP16/16/EHA** - 1600w x 1600d x 650-1280h
- PP14/16/EHA** - 1400w x 1600d x 650-1280h
- PP12/16/EHA** - 1200w x 1600d x 650-1280h

- PP18/12/EHA** - 1800w x 1200d x 650-1280h
- PP16/12/EHA** - 1600w x 1200d x 650-1280h
- PP14/12/EHA** - 1400w x 1200d x 650-1280h
- PP12/12/EHA** - 1200w x 1200d x 650-1280h



PPR16/8/EHA

Progress Plus Electric Height Adjustable Rectangular Desk

- 3 week lead time.
 - 25mm top panel.
 - Complete with a horizontal cable tray.
 - Sit / stand height adjustment of 650mm-1280mm via electronic up / down keypad.
 - Anti-collision as standard.
 - Pedestals 640h and over will clash with the subframe when in the lowest height setting.
- An Advanced Keypad can be specified to enable a minimum height setting to be configured preventing surface contact (page 17). The recommended pedestal for the standard keypad is an MPF, MP3, MPFM or MP3M (page 215).

- PPR18/8/EHA** - 1800w x 800d x 650-1280h
- PPR16/8/EHA** - 1600w x 800d x 650-1280h
- PPR14/8/EHA** - 1400w x 800d x 650-1280h
- PPR12/8/EHA** - 1200w x 800d x 650-1280h

- PPR18/6/EHA** - 1800w x 600d x 650-1280h
- PPR16/6/EHA** - 1600w x 600d x 650-1280h
- PPR14/6/EHA** - 1400w x 600d x 650-1280h
- PPR12/6/EHA** - 1200w x 600d x 650-1280h



PPR16/8/EHA/C

Progress Plus Electric Height Adjustable Rectangular Desk on Castors

- 3 week lead time.
 - 25mm top panel.
 - Complete with a horizontal cable tray.
 - Sit / stand height adjustment of 650mm-1280mm via electronic up / down keypad.
 - Anti-collision as standard.
 - Pedestals 640h and over will clash with the subframe when in the lowest height setting.
- An Advanced Keypad can be specified to enable a minimum height setting to be configured preventing surface contact (page 17). The recommended pedestal for the standard keypad is an MPF, MP3, MPFM or MP3M (page 215).

- PPR18/8/EHA/C** - 1800w x 800d x 730-1360h
- PPR16/8/EHA/C** - 1600w x 800d x 730-1360h
- PPR14/8/EHA/C** - 1400w x 800d x 730-1360h
- PPR12/8/EHA/C** - 1200w x 800d x 730-1360h

- PPR18/6/EHA/C** - 1800w x 600d x 730-1360h
- PPR16/6/EHA/C** - 1600w x 600d x 730-1360h
- PPR14/6/EHA/C** - 1400w x 600d x 730-1360h
- PPR12/6/EHA/C** - 1200w x 600d x 730-1360h



PP120/12/EHA

Progress Plus Electric Height Adjustable 120 Degree Workstation

- 3 week lead time.
 - 3x 25mm top panels.
 - Complete with a horizontal cable tray.
 - Sit / stand height adjustment of 650mm-1280mm via electronic up / down keypad.
 - Anti-collision as standard.
 - Pedestals 640h and over will clash with the subframe when in the lowest height setting.
- An Advanced Keypad can be specified to enable a minimum height setting to be configured preventing surface contact (page 17). The recommended pedestal for the standard keypad is an MPF, MP3, MPFM or MP3M (page 215).

- PP120/12/8/EHA** - 2920w (dia) x 650-1280h (1200w back edge x 800d return)
- PP120/12/6/EHA** - 2720w (dia) x 650-1280h (1200w back edge x 600d return)
- PP120/10/6/EHA** - 2372w (dia) x 650-1280h (1000w back edge x 600d return)

Progress Plus

Accessories



.../PPKP

Progress Plus Advanced Keypad

- Standard lead time.
- Upgrade Progress Plus standard keypad or retrofit.
- Extra features include setting upper and lower height restrictions, memory function and anti-collision sensitivity.
- To upgrade, suffix code to end of chosen desk (e.g. PPR16/8/EHA/PPKP).

.../PPKP3 - 120 Degree Workstation Upgrade at Point of Purchase

.../PPKP2 - Double Bench Upgrade at Point of Purchase

.../PPKP - Single Workstation Upgrade at Point of Purchase

PPKP3 - 120 Degree Workstation Retrofit after Purchase

PPKP2 - Double Bench Retrofit after Purchase

PPKP - Single Workstation Retrofit after Purchase



PPKPD

Progress Plus Advanced Keypad App Dongle

- Standard lead time.
- Progress Plus advanced keypad required for this product.
- For use with a mobile application, refer to Progress Plus user guide.
- Provides access to a healthy working programme.

PPKPD



PPLM
Illustrated in red

Progress Plus Locking Mechanism

- Standard lead time.
- Sold in pairs.
- Retrofittable locking mechanism.
- Located under bench top.

PPLM - Sold in Pairs

Progress Plus

Accessories

MFC: Available in Ash, Autumn Cherry, Beech, Chester Oak, English Walnut, Grey, Grey Nebraska Oak, Laurentii Wenge, Natural Nebraska Oak and White
Veneer: Available in Oak and Walnut (*3 Week Lead Time*)
Edging: Add surcharge for Wenge, Black and Plywood Effect per top - *Edging on 25mm White MFC only*
Metalwork: Silver, Black Graphite and White



PPDDSE

Progress Plus Decorative Slab End

- Standard lead time.
- For use on one end of the workstation (for use on both ends, specify 2x slab ends).

PPDDSE - For 1600d Ends - 1500w x 25d x 540h

PPDDSE12 - For 1200d Ends - 1100w x 25d x 540h

PPSDSE - For 800d Ends - 760w x 25d x 540h



PPSDSE



PPRMP16
Illustrated in red

Progress Plus Steel Modesty Panel

- Standard lead time.
- Modesty panels are 300mm high.

PPRMP18 - For 1800w Workstations - 1500w

PPRMP16 - For 1600w Workstations - 1300w

PPRMP14 - For 1400w Workstations - 1100w

PPRMP12 - For 1200w Workstations - 900w



PPRCT16
Illustrated in red

Progress Plus Double Bench Cable Tray

- Standard lead time.
- Compatible with Progress Plus double benches only.
- Cable tray positioned underneath fixed horizontal cable trays.
- Cable tray can be closed to cover exposed cables.
- Double bench cable trays are 230mm deep and 78mm high.

PPRCT18 - For 1800w Workstations - 1560w

PPRCT16 - For 1600w Workstations - 1360w

PPRCT14 - For 1400w Workstations - 1160w

PPRCT12 - For 1200w Workstations - 960w



Progress Plus

Accessories

Metalwork: Silver, Black Graphite and White



PPLCT
Illustrated in red

Progress Plus Double Bench Linking Cable Tray

- Standard lead time.
- Compatible with Progress Plus double benches with double bench cable tray only.
- Allows cables to pass safely between 2 double benches.
- Double bench cable trays are 135mm deep and 35mm high.

PPLCT - For All Workstations - 260w



PPFP
Illustrated in red

Progress Plus Linking Plate

- Standard lead time.
- Links Progress Plus workstations end to end to ensure a consistent / fixed gap of 25mm between work surfaces to reduce the risk of finger trapping.

PPFP - 208w x 180d



PPCR...
Illustrated in red

Progress Plus Double Bench Cable Riser

- Standard lead time.
- Compatible with Progress Plus double benches with double bench cable tray only.
- Connects at pre-fixed points along the workstation / cable tray.

PPCR/SB - Silver / Black

PPCR/BB - Black / Black

PPCR/WB - White / Black



TCRF...
Illustrated in red

Progress Plus Double Bench Track Cable Riser

- Standard lead time.
- Compatible with Progress Plus double benches with double bench cable tray only.
- Connects at pre-fixed points along the cable tray and finishes on the floor.

TCRF/SB - Silver / Black

TCRF/BB - Black / Black

TCRF/WB - White / Black



TCR...
Illustrated in red

Track Cable Riser

- Standard lead time.
- Connects at pre-determined points located on the underside of the cable tray.
- Free standing steel plate base.

TCR/SB - Silver / Black





TCR/BB - Black / Black

TCR/WB - White / Black

Progress Plus

Accessories, Featured Compatible Items and Compatibility Breakdown

Progress Plus Featured Compatible Items

				
Progress Plus CPU Holder <ul style="list-style-type: none"> Includes Progress Plus mounting kit. 	Maya Monitor Arm <ul style="list-style-type: none"> Clamp On and Bolt Through Desk Fixings. 	Maya Dual Monitor Arm <ul style="list-style-type: none"> Clamp On and Bolt Through Desk Fixings. 	Maya Laptop Stand <ul style="list-style-type: none"> Attaches onto Maya Monitor Arms. 	Slinky Cable Riser <ul style="list-style-type: none"> Suitable for all desk ranges.
PPCPU (Black) PPCPU/W (White)	MMA1/W (White) MMA1/B (Black)	MMA2/W (White) MMA2/B (Black)	MMA/LS/B (Black)	SCR/S (Silver) SCR/B (Black) SCR/W (White)
See page 310 for details.	See page 306 for details.	See page 306 for details.	See page 306 for details.	See page 310 for details.

Progress Plus Compatibility Breakdown



Progress Plus

Height Adjustable Conference Tables

3 Week Lead Time

MFC: Available in Ash, Autumn Cherry, Beech, Chester Oak, English Walnut, Grey, Grey Nebraska Oak, Laurentii Wenge, Natural Nebraska Oak and White
Nanotech: Available in Black (2 Week Lead Time)
Edging: Add surcharge for Wenge, Black and Plywood Effect per top - Edging on 25mm White MFC and Black Nanotech only
Metalwork: Silver, Black Graphite and White



PPCONF45

Progress Plus Electric Height Adjustable Half-Barrel Conference Table

- 3 week lead time.
- 2x 25mm top panels.
- Complete with horizontal cable trays.
- Sit / stand height adjustment of 650mm-1280mm via electronic up / down keypad situated on the desktop.
- Anti-collision as standard.

PPCONF45 - 4500w x 1800/1400d x 650-1280h
2x 2250mm Sections - Seating up to 14 People

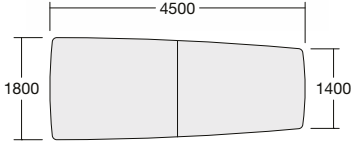

PPCONF30

Progress Plus Electric Height Adjustable Rectangular Conference Table

- 3 week lead time.
- 1x 25mm top panel.
- Complete with horizontal cable trays.
- Sit / stand height adjustment of 650mm-1280mm via electronic up / down keypad situated on the desktop.
- Anti-collision as standard.

PPCONF30 - 3000w x 1800d x 650-1280h
1x 3000mm Sections - Seating up to 10 People

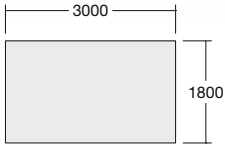

Progress Plus

Desk Mounted System Screens

- Fabric:** Fully upholstered with pinnable surface - *See below for pricing groups*
Acrylic: Available in Blue, Green, Orange, Red, Frosted and Clear
MFC: Available in Ash, Autumn Cherry, Beech, Chester Oak, English Walnut, Grey, Grey Nebraska Oak, Laurentii Wenge, Natural Nebraska Oak and White
Metalwork: Anodised Silver, Black Graphite and White
Fabric Groups: Group 1 - Add surcharge for Group 2-7



PPSS16F

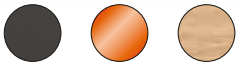

Fabric, Acrylic and MFC Finishes

Progress Plus Desk Mounted System Screen for Double Benches

- Standard lead time. • Straight dividing screens with aluminium trim. • All screens suitable for screen mounted accessories.
- Screen is bracketed to the double bench leg frames. • Link post not required.
- Available as Hygiene Protection Screens and add-ons (see HPS Guide).
- Optional screen mounted accessories available (page 293).

Straight System Screen without Management Rail

- PPSS18...** - 1662w x 27d x 765h
PPSS16... - 1462w x 27d x 765h
PPSS14... - 1262w x 27d x 765h
PPSS12... - 1062w x 27d x 765h

Finishes: Fabric System Screens without Management Rail (suffix ...F)
 Acrylic System Screens without Management Rail (suffix ...A)
 MFC System Screens without Management Rail (suffix ...MFC)



ESS16F

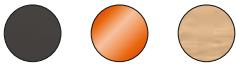

Fabric, Acrylic and MFC Finishes

Progress Plus Desk Mounted System Screen for Single Workstations

- Standard lead time. • Straight dividing screens with aluminium trim and optional management rail
- All screens suitable for screen mounted accessories.
- Screen is bracketed to the outer edge of the desk top. • Link post not required.
- Available as Hygiene Protection Screens and add-ons (see HPS Guide).
- Optional screen mounted accessories available (page 293).

Straight System Screen without Management Rail

- ESS18...** - 1773w x 27d x 375h
ESS16... - 1573w x 27d x 375h
ESS14... - 1373w x 27d x 375h
ESS12... - 1173w x 27d x 375h

Straight System Screen with Management Rail

- ESS18M...** - 1773w x 27d x 375h
ESS16M... - 1573w x 27d x 375h
ESS14M... - 1373w x 27d x 375h
ESS12M... - 1173w x 27d x 375h

Finishes: Fabric System Screens with or without Management Rail (suffix ...F)
 Acrylic System Screens with or without Management Rail (suffix ...A)
 MFC System Screens without Management Rail (suffix ...MFC)
 MFC System Screens with Management Rail (suffix .../MFC)

For use **without** Power Modules and Monitor Arms with brackets (no suffix)
 For use **with** Power Modules and Monitor Arms with brackets (creates a minimum 12mm void) (suffix .../V)



PPSS120/12F

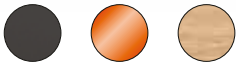

Fabric, Acrylic and MFC Finishes

Progress Plus Desk Mounted System Screen for 120 Degree Workstations

- Standard lead time. • Straight dividing screens with aluminium trim. • All screens suitable for screen mounted accessories.
- Screen is fixed to a Link Post at one end and is bracketed to the leg frame at the other.
- 3 way link post required (ELP765/120).
- Available as Hygiene Protection Screens and add-ons (see HPS Guide).
- Optional screen mounted accessories available (page 293).

Straight System Screen without Management Rail

- PPSS120/12...** - 1130w x 27d x 765h
PPSS120/10... - 930w x 27d x 765h

Finishes: Fabric System Screens without Management Rail (suffix ...F)
 Acrylic System Screens without Management Rail (suffix ...A)
 MFC System Screens without Management Rail (suffix ...MFC)

Additional: 3 way link post is required (ELP765/120)

Progress Plus

Desk Mounted Acoustic and Contract Screens

Fabric: Fully upholstered with pinnable (Acoustic and pinnable Contract) and non-pinnable (non-pinnable Contract) surface - See below for pricing groups

Fabric Groups: Group 1 - Add surcharge for Group 2-7



APPSS16F



Fabric Finish

Progress Plus Desk Mounted Acoustic Screen for Double Benches

- Standard lead time. • Straight dividing screens faced with 6mm polyester fibre insulation board.
- Screen is bracketed to the double bench leg frames. • Link post not required.
- Class B certified in accordance with International Standards: ISO 354:2003, ISO 11654:1997 and ISO 9613-1:1993
- Available as Hygiene Protection Screens and add-ons (see HPS Guide).

Straight Acoustic Screen

- APPSS18F** - 1662w x 38d x 765h
- APPSS16F** - 1462w x 38d x 765h
- APPSS14F** - 1262w x 38d x 765h
- APPSS12F** - 1062w x 38d x 765h



AESS16F



Fabric Finish

Progress Plus Desk Mounted Acoustic Screen for Single Workstations

- Standard lead time. • Straight dividing screens faced with 6mm polyester fibre insulation board.
- Screen is bracketed to the outer edge of the desk top. • Link post not required.
- Class B certified in accordance with International Standards: ISO 354:2003, ISO 11654:1997 and ISO 9613-1:1993
- Available as Hygiene Protection Screens and add-ons (see HPS Guide).

Straight Acoustic Screen

- AESS18F** - 1773w x 38d x 375h
- AESS16F** - 1573w x 38d x 375h
- AESS14F** - 1373w x 38d x 375h
- AESS12F** - 1173w x 38d x 375h

Compatibility: For use **without** Power Modules and Monitor Arms with brackets (no suffix)
For use **with** Power Modules and Monitor Arms with brackets (creates a minimum 12mm void) (suffix .../V)



PPPCS16FP



Fabric Finish

Progress Plus Desk Mounted Contract Screen for Double Benches

- Standard lead time. • Straight dividing screens with pinnable or non-pinnable fully upholstered surface.
- Pullover style fabric application. • Screen is bracketed to the double bench leg frames. • Link post not required.
- Available as Hygiene Protection Screens and add-ons (see HPS Guide).

Straight Pinnable Contract Screen

- PPPCS18FP** - 1662w x 38d x 765h
- PPPCS16FP** - 1462w x 38d x 765h
- PPPCS14FP** - 1262w x 38d x 765h
- PPPCS12FP** - 1062w x 38d x 765h

Straight Non-pinnable Contract Screen

- PPPCS18F** - 1662w x 27d x 765h
- PPPCS16F** - 1462w x 27d x 765h
- PPPCS14F** - 1262w x 27d x 765h
- PPPCS12F** - 1062w x 27d x 765h

Progress Plus

Desk Mounted Blade Screens

Fabric: Fully upholstered with pinnable surface - Available in Black, Grey, Light Grey, Blue and Red
Metalwork: Silver, Black Graphite and White



EBS16F/F3



Fabric Finish

Progress Plus Desk Mounted System Screen for Double Benches

- Standard lead time. • Straight dividing screens.
- Screen is bracketed to the outer edge of the desk top. • Link post not required.

Straight Blade Screen Panel

EBS18F... - For 1800w Workstations - 1180w x 16d x 360h
EBS16F... - For 1600w Workstations - 1180w x 16d x 360h
EBS14F... - For 1400w Workstations - 980w x 16d x 360h
EBS12F... - For 1200w Workstations - 980w x 16d x 360h

Finishes: Black (suffix .../F1), Grey (suffix .../F2), Light Grey (suffix .../F3), Blue (suffix .../F4) and Red (suffix .../F5) fabric



EBSMP16F/F3



Fabric Finish

Progress Plus Desk Mounted Blade Screen / Modesty Panel for Single Workstations

- Standard lead time. • Straight dividing screens with modesty panel overhang.
- Screen is bracketed to the outer edge of the desk top. • Link post not required.

Straight Blade Screen / Modesty Panel

EBSMP18F... - For 1800w Workstations - 1180w x 16d x 580h
EBSMP16F... - For 1600w Workstations - 1180w x 16d x 580h

Finishes: Black (suffix .../F1), Grey (suffix .../F2), Light Grey (suffix .../F3), Blue (suffix .../F4) and Red (suffix .../F5) fabric



EBSER8F/F3



Fabric Finish

Progress Plus Desk Mounted Blade End Return Panel for Single Workstations

- Standard lead time. • Straight dividing screens.
- Screen is bracketed to the outer edge of the desk top. • Link post not required.

Straight Blade Screen Panel

EBSER8F... - For 800d Workstations - 580w x 16d x 360h

Finishes: Black (suffix .../F1), Grey (suffix .../F2), Light Grey (suffix .../F3), Blue (suffix .../F4) and Red (suffix .../F5) fabric

Blade Fabric Finishes

- The 5 finishes below are available on the Blade Screen Panels above.



Black (.../F1)



Grey (.../F2)



Light Grey (.../F3)



Blue (.../F4)



Red (.../F5)

Whilst every effort has been made to ensure accurate colours are illustrated in this document, there may be a slight colour difference due to the printing process, therefore please refer to our colour sample swatches prior to ordering.

Progress

Gas Strut Sit / Stand and Fixed Height Workstations, Meeting and Screens

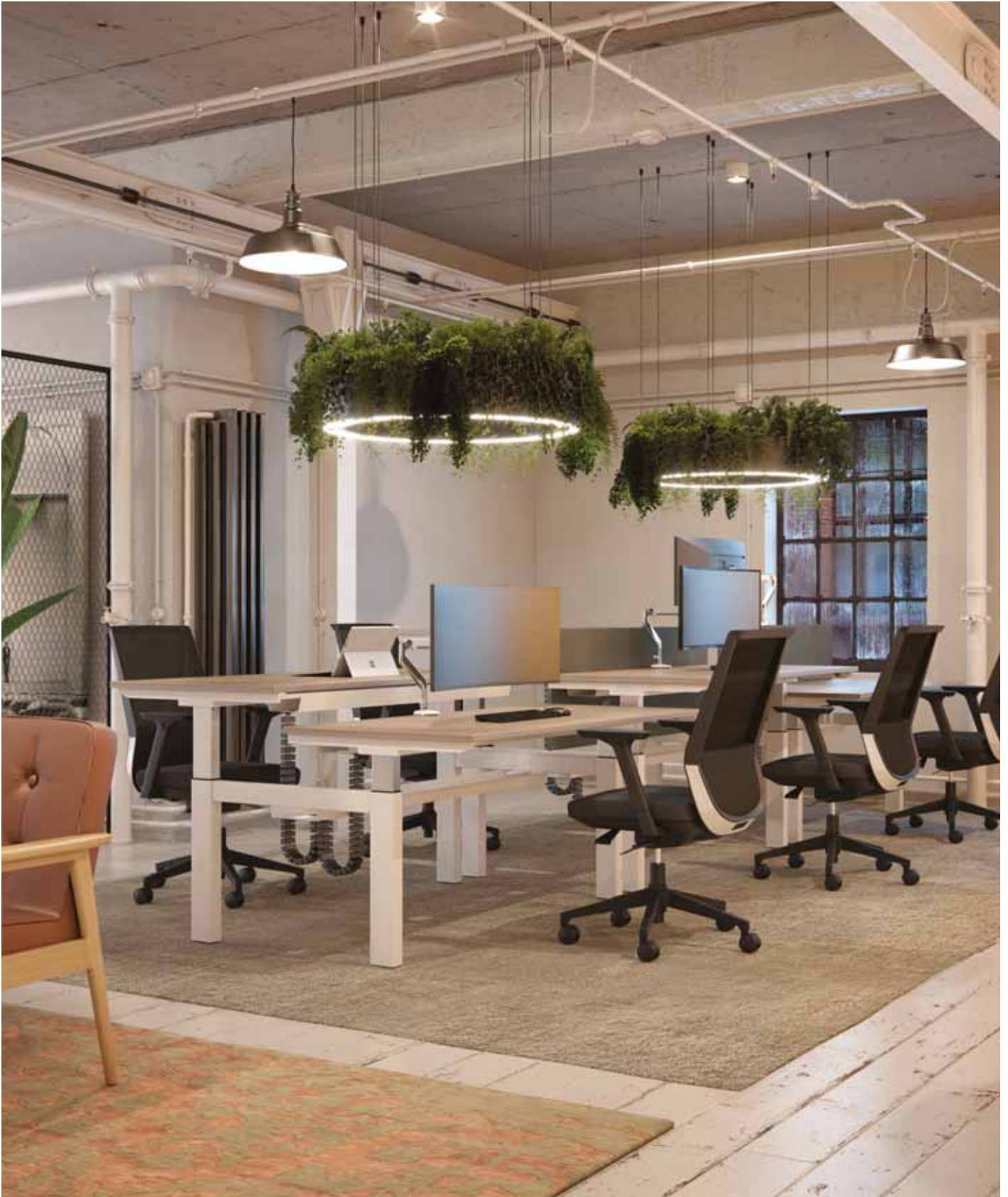

Progress offers complete flexibility with options including fixed height and gas strut height adjustment. Each option can be fitted after the initial installation, should the user's requirements change. For example, a fixed height workstation can be converted to include height adjustment by swapping the leg uprights only. All components are fully interchangeable for maximum flexibility. The sit-stand aspect brings significant health benefits encouraging wellbeing within the office environment. Height adjustable workstations offer height variation from 685mm to 1185mm. Double benches are supplied with sliding tops as standard, enhancing the flexibility of the desking system. Horizontal wire management is inclusive under each desk top on both the single and double benches. Decorative slab end panels can be fitted to both single and double workstations to enhance the aesthetics at the end of a run of workstations, offering a more executive appearance.



Introduction

For correct use of Progress gas strut height adjustable sit / stand desks, it is essential to identify the proposed loading for each desk top. Failure to identify the required loading will result in the gas strut experiencing insufficient or excessive force. See illustrations below:



How to Calculate Loading Weights

To find the correct level for all gas strut workstations, you will need to identify the weights to be loaded onto each individual desk top including equipment suspended from its sub-frame.

For Example:

Desktop Monitor, Keyboard, Mouse, CPU Tower, Laptop, Printers, Speakers, Telephone, Accessories, Power Modules, Lighting, etc.

Calculation:

$$\text{Elite Manufactured Items (kg)} + \text{Client Items (kg)} = \text{Total Weight (kg)}$$

Once the total weight is known you can specify the gas strut required from options A-F below. The letter must be suffixed to the desk code you require.

.../A Below 4.9kg	.../B 5.0kg - 9.9kg	.../C 10.0kg - 14.9kg
.../D 15.0kg - 19.9kg	.../E 20.0kg - 24.9kg	.../F 25.0kg - 30.0kg



Example 01

1600mm Double Bench
14kg Top Weight on Desktop 1
27kg Top Weight on Desktop 2

Gas Strut 'C' and 'F' will need to be specified.

Code: P16/16/HA/C/F



Example 02

1600mm Single Desk
8kg Top Weight

Gas Strut 'B' will need to be specified.

Code: PR16/8/HA/B

MFC:	Available in Ash, Autumn Cherry, Beech, Chester Oak, English Walnut, Grey, Grey Nebraska Oak, Laurentii Wenge, Natural Nebraska Oak and White
Veneer:	Available in Oak and Walnut (3 Week Lead Time)
Edging:	Add surcharge for Wenge, Black and Plywood Effect per top - Edging on 25mm White MFC only
Metalwork:	Silver and White



P16/16/HA...

Progress Height Adjustable Double Bench

- 6 week lead time.
- 2x 25mm sliding top panel.
- Complete with 2x horizontal cable trays.
- Sit / stand height adjustment of 685mm-1185mm via gas strut release.
- Suffix below codes with relevant gas strut option (e.g. **PR16/16/HA/C/D**).
- For more technical information, see page 26.

P18/16/HA/.../... - 1800w x 1600d x 685-1185h

P16/16/HA/.../... - 1600w x 1600d x 685-1185h

P14/16/HA/.../... - 1400w x 1600d x 685-1185h

Compatibility: For a load below 4.9kg (suffix **.../A**), between 5.0kg - 9.9kg (suffix **.../B**), between 10.0kg - 14.9kg (suffix **.../C**), between 15.0kg - 19.9kg (suffix **.../D**), between 20.0kg - 24.9kg (suffix **.../E**) and between 25.0kg - 30.0kg (suffix **.../F**)
Do the above twice for both desktops



PR16/8/HA...

Progress Height Adjustable Rectangular Desk

- Available in White RAL 9003 only.
- 6 week lead time.
- 25mm top panel.
- Complete with a horizontal cable tray.
- Sit / stand height adjustment of 685mm-1185mm via gas strut release.
- Suffix below codes with relevant gas strut option (e.g. **PR16/8/HA/C**).
- For more technical information, see page 26.

PR18/8/HA/... - 1800w x 800d x 685-1185h - White RAL 9003 Only

PR16/8/HA/... - 1600w x 800d x 685-1185h - White RAL 9003 Only

PR14/8/HA/... - 1400w x 800d x 685-1185h - White RAL 9003 Only

Compatibility: For a load below 4.9kg (suffix **.../A**), between 5.0kg - 9.9kg (suffix **.../B**), between 10.0kg - 14.9kg (suffix **.../C**), between 15.0kg - 19.9kg (suffix **.../D**), between 20.0kg - 24.9kg (suffix **.../E**) and between 25.0kg - 30.0kg (suffix **.../F**)



P16/16

Progress Fixed Height Double Bench

- 6 week lead time.
- 2x 25mm sliding top panels.
- Complete with 2x horizontal cable trays.

P18/16 - 1800w x 1600d x 740h

P16/16 - 1600w x 1600d x 740h

P14/16 - 1400w x 1600d x 740h



PR16/8

Progress Fixed Height Rectangular Desk

- 6 week lead time.
- 25mm sliding top panels.
- Complete with horizontal cable tray.

PR18/8 - 1800w x 800d x 740h

PR16/8 - 1600w x 800d x 740h

PR14/8 - 1400w x 800d x 740h



P120

Progress Fixed Height 120 Degree Workstation

- 6 week lead time.
- 3x 25mm top panels.
- Complete with 6x horizontal cable trays (2x per top).

P120 - 2920w (dia) x 740h (1200w back edge x 800d return)

Progress

Accessories

MFC: Available in Ash, Autumn Cherry, Beech, Chester Oak, English Walnut, Grey, Grey Nebraska Oak, Laurentii Wenge, Natural Nebraska Oak and White
Veneer: Available in Oak and Walnut (*3 Week Lead Time*)
Edging: Add surcharge for Wenge, Black and Plywood Effect per top - *Edging on 25mm White MFC only*
Metalwork: Silver and White



PDDSE



PSDSE

Progress Decorative Slab End

- Standard lead time.
- For use on one end of the workstation (for use on both ends, specify 2x slab ends).

PDDSE - For 1600d Ends - 1500w x 97d x 600h

PSDSE - For 800d Ends - 700w x 97d x 600h

Compatibility: For use without the double bench cable tray (no suffix)
For use with the double bench cable tray (suffix **.../X** (*PDDSE only*))



PRMP16
Illustrated in red

Progress Steel Modesty Panel

- Standard lead time.
- Modesty panels are 275mm high.

PRMP18 - For 1800w Workstations - 1500w - (7.0kg)

PRMP16 - For 1600w Workstations - 1300w - (6.1kg)

PRMP14 - For 1400w Workstations - 1100w - (5.2kg)



PRCT16
Illustrated in red

Progress Double Bench Cable Tray

- Standard lead time.
- Compatible with Progress double benches only.
- Double bench cable trays are 200mm deep and 45mm high.

PRCT18 - For 1800w Workstations - 1660w

PRCT16 - For 1600w Workstations - 1460w

PRCT14 - For 1400w Workstations - 1260w

Progress

Accessories, Featured Compatible Items and Compatibility Breakdown

Metalwork: Silver and White



PFP
Illustrated in red

Progress Linking Plate

- Standard lead time.
- Links Progress double bench and 120 degree workstations end to end to ensure a consistent / fixed gap of 25mm between work surfaces to reduce the risk of finger trapping.

PFP - 188w x 180d



PCR...
Illustrated in red

Progress Double Bench Cable Riser

- Standard lead time.
- Compatible with Progress double benches with double bench cable tray PRCT only.
- Connects to the right or left-hand side of the workstation / cable tray.

PCR/S - Silver
PCR/B - Black
PCR/W - White

Progress Featured Compatible Items



Progress CPU Holder

- Includes Progress mounting kit.

PCPU (Black)
PCPU/W (White)

See page 310 for details.



Maya Monitor Arm

- Clamp On and Bolt Through Desk Fixings.

MMA1/W (White)
MMA1/B (Black)

See page 306 for details.



Maya Dual Monitor Arm

- Clamp On and Bolt Through Desk Fixings.

MMA2/W (White)
MMA2/B (Black)

See page 306 for details.



Maya Laptop Stand

- Attaches onto Maya Monitor Arms.

MMA/LS/B (Black)

See page 306 for details.



Slinky Cable Riser

- Suitable for all desk ranges.

SCR/S (Silver)
SCR/B (Black)
SCR/W (White)

See page 310 for details.

Progress Compatibility Breakdown

- **Black** - Compatible
- **Orange** - Non-standard position required
- **Blue** - Conflict when using screens without .../V

- Progress - Double Benches
- Progress - Rectangular
- Progress - 120 Degree
- Progress - Conference / Meeting

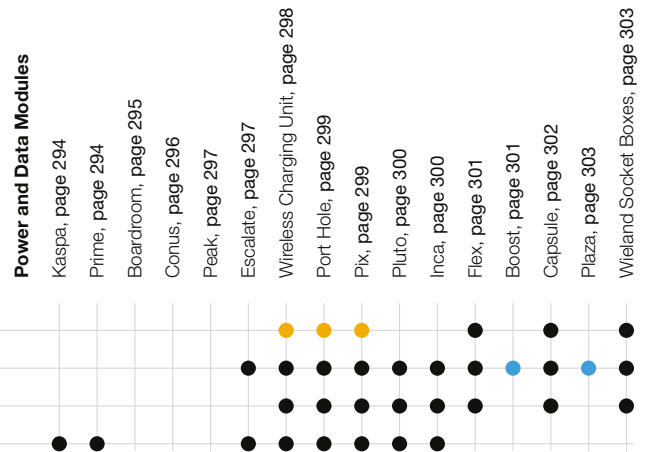

Progress

Fixed Height Conference and Meeting Tables and Accessories

6 Week Lead Time

MFC: Available in Ash, Autumn Cherry, Beech, Chester Oak, English Walnut, Grey, Grey Nebraska Oak, Laurentii Wenge, Natural Nebraska Oak and White
Veneer: Available in Oak and Walnut (3 Week Lead Time)
Edging: Add surcharge for Wenge, Black and Plywood Effect per top - Edging on 25mm White MFC only
Metalwork: Silver and White



PCONF2

Progress Fixed Height Rectangular Conference Table

• 6 week lead time. • 2x 25mm top panels.

PCONF2 - 3400w x 1200d x 740h
2x 1700mm Sections - Seating up to 10 People



PCONF1A

Progress Fixed Height Rectangular Conference Table

• 6 week lead time. • 25mm top panel.

PCONF1B - 2400w x 1200d x 740h
1x 2400mm Sections - Seating up to 8 People

PCONF1A - 2000w x 1200d x 740h
1x 2000mm Sections - Seating up to 8 People



PRMT20/10

Progress Fixed Height Rectangular Meeting Table

• 6 week lead time. • 25mm top panel.

PRMT22/10 - 2200w x 1000d x 740h

PRMT20/10 - 2000w x 1000d x 740h

PRMT20/8 - 2000w x 800d x 740h



PRCT20
Illustrated in red

Progress Meeting Cable Tray

• Standard lead time. • Compatible with Progress conference and meeting tables only.
• Meeting cable trays are 100mm deep and 110mm high.

PRCT34 - For PCONF2 - Sold in 2x Sections - 2x 900w

PRCT24 - For PCONF1B - 1300w

PRCT22 - For 2200w Meeting Tables - 1100w

PRCT20 - For PCONF1A and 2000w Meeting Tables - 900w

Progress

Desk Mounted System Screens

- Fabric:** Fully upholstered with pinnable surface - *See below for pricing groups*
Acrylic: Available in Blue, Green, Orange, Red, Frosted and Clear
MFC: Available in Ash, Autumn Cherry, Beech, Chester Oak, English Walnut, Grey, Grey Nebraska Oak, Laurentii Wenge, Natural Nebraska Oak and White
Metalwork: Anodised Silver, Black Graphite and White
Fabric Groups: Group 1 - Add surcharge for Group 2-7



PSS16F

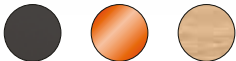

Fabric, Acrylic and MFC Finishes

Progress Desk Mounted System Screen for Double Benches

- Standard lead time. • Straight dividing screens with aluminium trim. • All screens suitable for screen mounted accessories.
- Screen is bracketed to the double bench leg frames. • Link post not required.
- Available as Hygiene Protection Screens and add-ons (see HPS Guide).
- Optional screen mounted accessories available (page 293).

Straight System Screen

- PSS18...** - 1653w x 27d x 600h
PSS16... - 1453w x 27d x 600h
PSS14... - 1253w x 27d x 600h

Finishes: Fabric System Screens without Management Rail (suffix ...F)
 Acrylic System Screens without Management Rail (suffix ...A)
 MFC System Screens without Management Rail (suffix ...MFC)



ESS16F

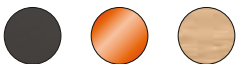

Fabric, Acrylic and MFC Finishes

Progress Desk Mounted System Screen for Workstations Desks

- Standard lead time. • Straight dividing screens with aluminium trim and optional management rail.
- All screens suitable for screen mounted accessories.
- Screen is bracketed to the outer edge of the desk top. • Link post not required.
- Available as Hygiene Protection Screens and add-ons (see HPS Guide).
- Optional screen mounted accessories available (page 293).

Straight System Screen

- ESS18...** - 1773w x 27d x 375h
ESS16... - 1573w x 27d x 375h
ESS14... - 1373w x 27d x 375h

Straight System Screen with Management Rail

- ESS18M...** - 1773w x 27d x 375h
ESS16M... - 1573w x 27d x 375h
ESS14M... - 1373w x 27d x 375h

Finishes: Fabric System Screens with or without Management Rail (suffix ...F)
 Acrylic System Screens with or without Management Rail (suffix ...A)
 MFC System Screens without Management Rail (suffix ...MFC)
 MFC System Screens with Management Rail (suffix .../MFC)

For use **without** Power Modules and Monitor Arms with brackets (no suffix)
 For use **with** Power Modules and Monitor Arms with brackets (creates a minimum 12mm void) (suffix .../V)



PSS120/12F

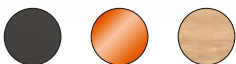

Fabric, Acrylic and MFC Finishes

Progress Desk Mounted System Screen for 120 Degree Workstations

- Standard lead time. • Straight dividing screens with aluminium trim. • All screens suitable for screen mounted accessories.
- Screen is fixed to a Link Post at one end and is bracketed to the leg frame at the other.
- 3 way link post required (ELP600/120).
- Available as Hygiene Protection Screens and add-ons (see HPS Guide).
- Optional screen mounted accessories available (page 293).

Straight System Screen

- PSS120/12...** - 1110w x 27d x 600h

Finishes: Fabric System Screens without Management Rail (suffix ...F)
 Acrylic System Screens without Management Rail (suffix ...A)
 MFC System Screens without Management Rail (suffix ...MFC)

Additional: 3 way link post is required (ELP600/120)

Progress

Desk Mounted Acoustic Screens

Fabric: Fully upholstered with pinnable surface (unless specified) - See below for pricing groups

Fabric Groups: Group 1 - Add surcharge for Group 2-7



APSS16F



Fabric Finish

Progress Desk Mounted Acoustic Screen for Double Benches

- Standard lead time. • Straight dividing screens faced with 6mm polyester fibre insulation board.
- Screen is bracketed to the double bench leg frames. • Link post not required.
- Class B certified in accordance with International Standards: ISO 354:2003, ISO 11654:1997 and ISO 9613-1:1993
- Available as Hygiene Protection Screens and add-ons (see HPS Guide).

Straight Acoustic Screen

APSS18F - 1653w x 38d x 600h

APSS16F - 1453w x 38d x 600h

APSS14F - 1253w x 38d x 600h



AESS16F



Fabric Finish

Progress Desk Mounted Acoustic Screen for Single Workstations

- Standard lead time. • Straight dividing screens faced with 6mm polyester fibre insulation board.
- Screen is bracketed to the outer edge of the desk top. • Link post not required.
- Class B certified in accordance with International Standards: ISO 354:2003, ISO 11654:1997 and ISO 9613-1:1993
- Available as Hygiene Protection Screens and add-ons (see HPS Guide).

Straight Acoustic Screen

AESS18F - 1773w x 38d x 375h

AESS16F - 1573w x 38d x 375h

AESS14F - 1373w x 38d x 375h

Compatibility: For use without Power Modules and Monitor Arms with brackets (no suffix)
For use with Power Modules and Monitor Arms with brackets (creates a minimum 12mm void) (suffix .../V)

Progress

Desk Mounted Blade Screens

Fabric: Fully upholstered with pinnable surface - Available in Black, Grey, Light Grey, Blue and Red
Metalwork: Silver, Black Graphite and White



EBS16F/F3



Fabric Finish

Progress Desk Mounted System Screen for Double Benches

- Standard lead time. • Straight dividing screens.
- Screen is bracketed to the outer edge of the desk top. • Link post not required.

Straight Blade Screen Panel

EBS18F... - For 1800w Workstations - 1180w x 16d x 360h
EBS16F... - For 1600w Workstations - 1180w x 16d x 360h
EBS14F... - For 1400w Workstations - 980w x 16d x 360h

Finishes: Black (suffix .../F1), Grey (suffix .../F2), Light Grey (suffix .../F3), Blue (suffix .../F4) and Red (suffix .../F5) fabric



EBSMP16F/F3



Fabric Finish

Progress Desk Mounted Blade Screen / Modesty Panel for Single Workstations

- Standard lead time. • Straight dividing screens with modesty panel overhang.
- Screen is bracketed to the outer edge of the desk top. • Link post not required.

Straight Blade Screen / Modesty Panel

EBSMP18F... - For 1800w Workstations - 1180w x 16d x 580h
EBSMP16F... - For 1600w Workstations - 1180w x 16d x 580h

Finishes: Black (suffix .../F1), Grey (suffix .../F2), Light Grey (suffix .../F3), Blue (suffix .../F4) and Red (suffix .../F5) fabric



EBSER8F/F3



Fabric Finish

Progress Desk Mounted Blade End Return Panel for Single Workstations

- Standard lead time. • Straight dividing screens.
- Screen is bracketed to the outer edge of the desk top. • Link post not required.

Straight Blade Screen Panel

EBSER8F... - For 800d Workstations - 580w x 16d x 360h

Finishes: Black (suffix .../F1), Grey (suffix .../F2), Light Grey (suffix .../F3), Blue (suffix .../F4) and Red (suffix .../F5) fabric

Blade Fabric Finishes

- The 5 finishes below are available on the Blade Screen Panels above.

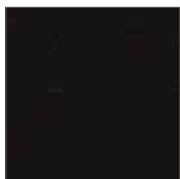

Black (.../F1)



Grey (.../F2)



Light Grey (.../F3)



Blue (.../F4)



Red (.../F5)

Whilst every effort has been made to ensure accurate colours are illustrated in this document, there may be a slight colour difference due to the printing process, therefore please refer to our colour sample swatches prior to ordering.

Progress Lite

Manual Sit / Sit Workstations and Screens

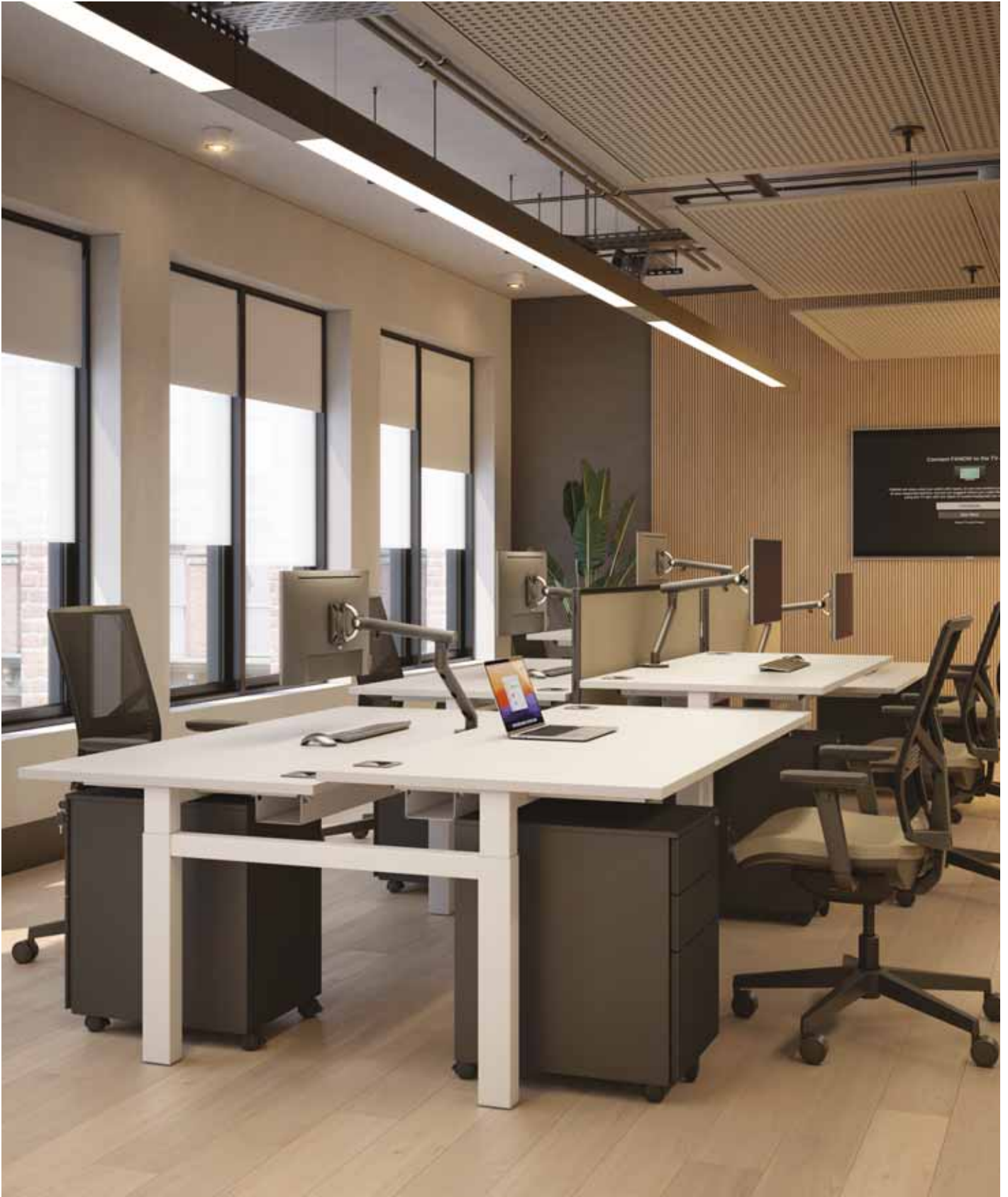

Progress Lite is a height adjustable double bench, inclusive of a horizontal cable tray under each desk top. The system offers height adjustment from 650mm to 850mm via a rotating crank handle that can be folded into a recess within the frame, when not in use. Screen panels are compatible with Progress Lite providing the flexibility to segregate each user's space.



Progress Lite

Height Adjustable Workstations and Accessories

6 Week Lead Time

MFC: Available in Ash, Autumn Cherry, Beech, Chester Oak, English Walnut, Grey, Grey Nebraska Oak, Laurentii Wenge, Natural Nebraska Oak and White
Veneer: Available in Oak and Walnut (3 Week Lead Time)
Edging: Add surcharge for Wenge, Black and Plywood Effect per top - Edging on 25mm White MFC only
Metalwork: Silver and White



PL16/16/HA

Progress Lite Height Adjustable Double Bench

- 6 week lead time.
- 2x 25mm top panels.
- Complete with 2x horizontal cable trays.
- Sit / sit height adjustment of 650mm-850mm via crank handle.

- PL18/16/HA** - 1800w x 1600d x 650-850h
- PL16/16/HA** - 1600w x 1600d x 650-850h
- PL14/16/HA** - 1400w x 1600d x 650-850h



PLFP
Illustrated in red

Progress Lite Linking Plate

- Standard lead time.
- Links Progress Lite double benches end to end to ensure a consistent / fixed gap of 15mm between worksurfaces to reduce the risk of finger trapping.

- PLFP** - 188w x 180d

Progress Lite Featured Compatible Items



Progress Lite CPU Holder
 • Includes Progress Lite mounting kit.

- PLCPU** (Black)
- PLCPU/W** (White)

See page 310 for details.



Maya Monitor Arm
 • Clamp On and Bolt Through Desk Fixings.

- MMA1/W** (White)
- MMA1/B** (Black)

See page 306 for details.



Maya Dual Monitor Arm
 • Clamp On and Bolt Through Desk Fixings.

- MMA2/W** (White)
- MMA2/B** (Black)

See page 306 for details.



Maya Laptop Stand
 • Attaches onto Maya Monitor Arms.

- MMA/LS/B** (Black)

See page 306 for details.



Slinky Cable Riser
 • Suitable for all desk ranges.

- SCR/S** (Silver)
- SCR/B** (Black)
- SCR/W** (White)

See page 310 for details.

Progress Lite Compatibility Breakdown



Progress Lite

Acoustic and Hygiene Protection Screens

- Fabric:** Fully upholstered with pinnable surface - *See below for pricing groups*
Acrylic: Available in Blue, Green, Orange, Red, Frosted and Clear
MFC: Available in Ash, Autumn Cherry, Beech, Chester Oak, English Walnut, Grey, Grey Nebraska Oak, Laurentii Wenge, Natural Nebraska Oak and White
Metalwork: Anodised Silver, Black Graphite and White
Fabric Groups: Group 1 - Add surcharge for Group 2-7



PLSS16F

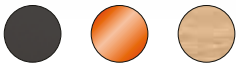

Fabric, Acrylic and MFC Finishes

Progress Lite Desk Mounted System Screen for Double Benches

- Standard lead time. • Straight dividing screens with aluminium trim and optional management rail.
- All screens suitable for screen mounted accessories.
- Screen is bracketed to the double bench leg frames. • Link post not required.
- Available as Hygiene Protection Screens and add-ons (see HPS Guide).
- Optional screen mounted accessories available (page 293).

Straight System Screen

- PLSS18...** - 1707w x 27d x 550h
PLSS16... - 1507w x 27d x 550h
PLSS14... - 1307w x 27d x 550h

Straight System Screen with Management Rail

- PLSS18M...** - 1707w x 27d x 550h
PLSS16M... - 1507w x 27d x 550h
PLSS14M... - 1307w x 27d x 550h

- Finishes:** Fabric System Screens with or without Management Rail (suffix ...F)
 Acrylic System Screens with or without Management Rail (suffix ...A)
 MFC System Screens without Management Rail (suffix ...MFC)
 MFC System Screens with Management Rail (suffix .../MFC)



APLSS16F



Fabric Finish

Progress Lite Desk Mounted Acoustic Screen for Double Benches

- Standard lead time. • Straight dividing screens faced with 6mm polyester fibre insulation board.
- Screen is bracketed to the double bench leg frames. • Link post not required.
- Class B certified in accordance with International Standards: ISO 354:2003, ISO 11654:1997 and ISO 9613-1:1993
- Available as Hygiene Protection Screens and add-ons (see HPS Guide).

Straight Acoustic Screen

- APLSS18F** - 1707w x 38d x 550h
APLSS16F - 1507w x 38d x 550h
APLSS14F - 1307w x 38d x 550h

Linnea Elevate

Fixed Height Workstations and Screens

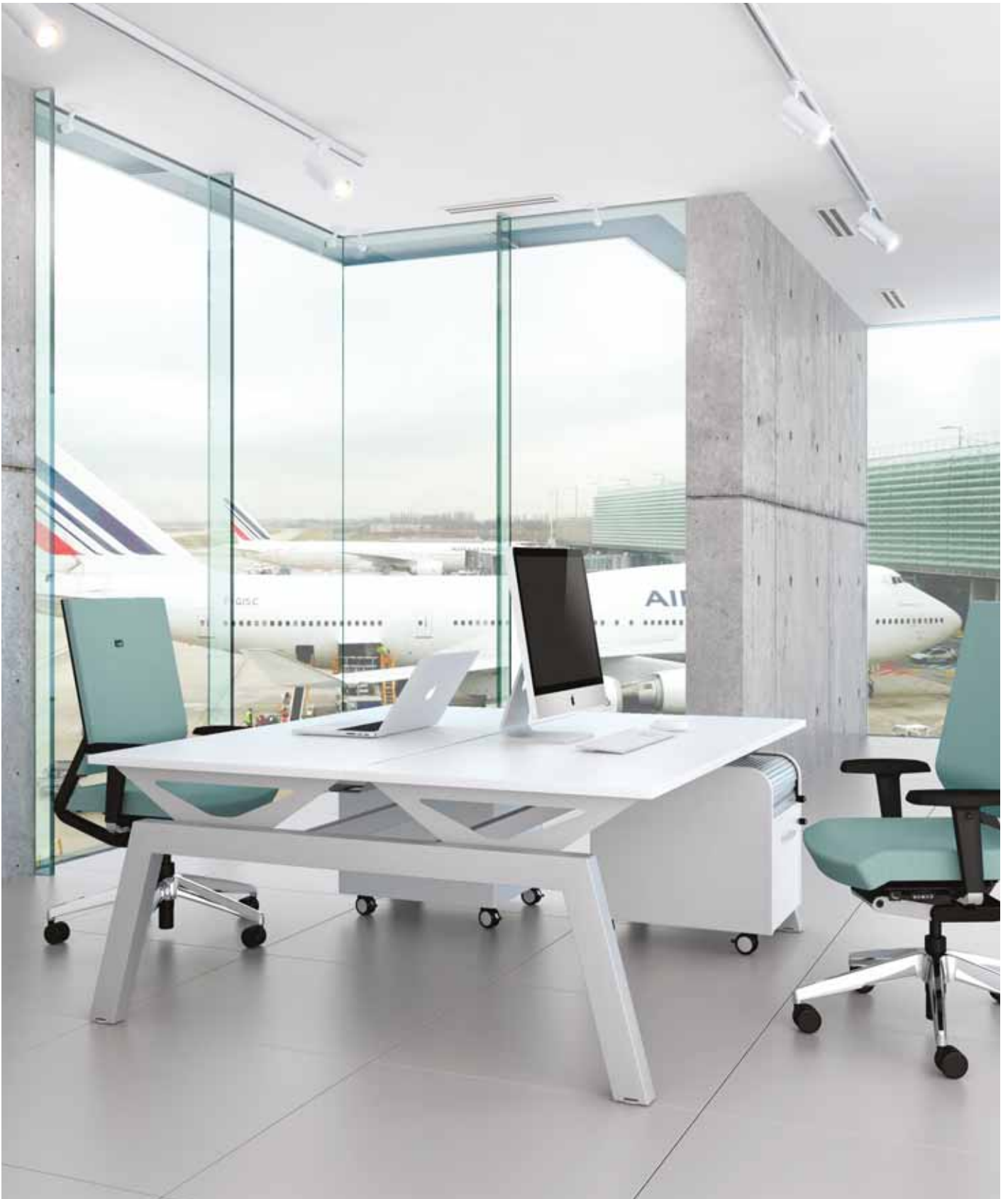

The Linnea Elevate range includes single and double benches. Horizontal wire management is standard on each workstation with the added feature of sliding tops for simple access to cables. Decorative slab end panels are options that enhance the appearance of the legs and provide added privacy when configured in clusters. Other options include modesty panels for single workstations and horizontal wire management trays for double benches, providing a dynamic facility to house complex cable installations.



Linnea Elevate

Fixed Height Workstations and Accessories

2 Week Lead Time

MFC:	Available in Ash, Autumn Cherry, Beech, Chester Oak, English Walnut, Grey, Grey Nebraska Oak, Laurentii Wenge, Natural Nebraska Oak and White
Veneer:	Available in Oak and Walnut (<i>3 Week Lead Time</i>)
Edging:	Add surcharge for Wenge, Black and Plywood Effect per top - <i>Edging on 25mm White MFC only</i>
Metalwork:	Silver, Black Graphite and White



LE16/16

Linnea Elevate Fixed Height Double Bench

- 2 week lead time.
- 2x 25mm sliding top panels.
- Complete with 2x horizontal cable trays.
- Actual top width is 10mm less than frame size stated.

LE18/16	- 1800w x 1600d x 740h
LE16/16	- 1600w x 1600d x 740h
LE14/16	- 1400w x 1600d x 740h
LE12/16	- 1200w x 1600d x 740h



LE16/16/INT

Linnea Elevate Fixed Height Double Bench with Shared Inset Intermediate Leg

- 2 week lead time.
- 2x 25mm sliding top panels.
- Complete with 2x horizontal cable trays.
- Actual top width is 10mm less than frame size stated.

LE18/16/INT	- 1800w x 1600d x 740h
LE16/16/INT	- 1600w x 1600d x 740h
LE14/16/INT	- 1400w x 1600d x 740h
LE12/16/INT	- 1200w x 1600d x 740h



LER16/8

Linnea Elevate Fixed Height Rectangular Desk

- 2 week lead time.
- 25mm sliding top panel.
- Complete with a horizontal cable tray.
- Actual top width is 10mm less than frame size stated.

LER18/8	- 1800w x 800d x 740h
LER16/8	- 1600w x 800d x 740h
LER14/8	- 1400w x 800d x 740h
LER12/8	- 1200w x 800d x 740h



LER16/8/INT

Linnea Elevate Fixed Height Rectangular Desk with Shared Inset Intermediate Leg

- 2 week lead time.
- 25mm sliding top panel.
- Complete with a horizontal cable tray.
- Actual top width is 10mm less than frame size stated.

LER18/8/INT	- 1800w x 800d x 740h
LER16/8/INT	- 1600w x 800d x 740h
LER14/8/INT	- 1400w x 800d x 740h
LER12/8/INT	- 1200w x 800d x 740h



LEDDSE

Linnea Elevate Decorative Slab End

- Standard lead times.
- Cannot be retrofitted.
- For use on one end of the workstation (for use on both ends, specify 2x slab ends).

LEDDSE	- For 1600d Ends
LESDSE... (LH or RH)	- For 800d Ends



LESSELH

Linnea Elevate

Accessories, Featured Compatible Items and Compatibility Breakdown

Metalwork: Silver, Black Graphite and White



LERMP16
Illustrated in red

Linnea Elevate Steel Modesty Panel

- Modesty panels are 305mm high.

- LERMP18** - For 1800w Workstations - 1675w
- LERMP16** - For 1600w Workstations - 1475w
- LERMP14** - For 1400w Workstations - 1275w
- LERMP12** - For 1200w Workstations - 1075w



LERCT16
Illustrated in red

Linnea Elevate High Capacity Cable Tray

- Compatible with Linnea Elevate double benches only.
- Cable trays are 350mm deep and 80mm high.

- LERCT18** - For 1800w Workstations - 1600w
- LERCT16** - For 1600w Workstations - 1400w
- LERCT14** - For 1400w Workstations - 1200w
- LERCT12** - For 1200w Workstations - 1000w

Linnea Elevate Featured Compatible Items



Linnea Elevate CPU Holder

- Includes Progress mounting kit.

LECPU (Black)
LECPU/W (White)

See page 310 for details.



Maya Monitor Arm

- Clamp On and Bolt Through Desk Fixings.

MMA1/W (White)
MMA1/B (Black)

See page 306 for details.



Maya Dual Monitor Arm

- Clamp On and Bolt Through Desk Fixings.

MMA2/W (White)
MMA2/B (Black)

See page 306 for details.



Maya Laptop Stand

- Attaches onto Maya Monitor Arms.

MMA/LS/B (Black)

See page 306 for details.



Slinky Cable Riser

- Suitable for all desk ranges.

SCR/S (Silver)
SCR/B (Black)
SCR/W (White)

See page 310 for details.

Linnea Elevate Compatibility Breakdown

● **Black** - Compatible

● **Blue** - Conflict when using screens without .../V

	Power and Data Modules	Kaspa, page 294	Prime, page 294	Boardroom, page 295	Conus, page 296	Peak, page 297	Escalate, page 297	Wireless Charging Unit, page 298	Port Hole, page 299	Pix, page 299	Pluto, page 300	Inca, page 300	Flex, page 301	Boost, page 301	Capsule, page 302	Plaza, page 303	Wieland Socket Boxes, page 303
Linnea Elevate - Double Benches								●					●	●	●	●	●
Linnea Elevate - Rectangular													●	●	●	●	●

Linnea Elevate

Desk Mounted System Screens

Fabric:	Fully upholstered with pinnable surface - <i>See below for pricing groups</i>
Acrylic:	Available in Blue, Green, Orange, Red, Frosted and Clear
MFC:	Available in Ash, Autumn Cherry, Beech, Chester Oak, English Walnut, Grey, Grey Nebraska Oak, Laurentii Wenge, Natural Nebraska Oak and White
Metalwork:	Anodised Silver, Black Graphite and White
Fabric Groups:	Group 1 - Add surcharge for Group 2-7



LESS16F

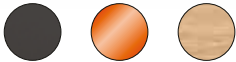

Fabric, Acrylic and MFC Finishes

Linnea Elevate Desk Mounted System Screen for Double Benches

- Standard lead time.
- Straight dividing screens with aluminium trim and optional management rail.
- All screens suitable for screen mounted accessories.
- Screen is bracketed to the double bench leg frames.
- Link post not required.
- Available as Hygiene Protection Screens and add-ons (see HPS Guide).
- Optional screen mounted accessories available (page 293).

Straight System Screen

- LESS18...** - 1707w x 27d x 550h
- LESS16...** - 1507w x 27d x 550h
- LESS14...** - 1307w x 27d x 550h
- LESS12...** - 1107w x 27d x 550h

Straight System Screen with Management Rail

- LESS18M...** - 1707w x 27d x 550h
- LESS16M...** - 1507w x 27d x 550h
- LESS14M...** - 1307w x 27d x 550h
- LESS12M...** - 1107w x 27d x 550h

Finishes:	Fabric System Screens with or without Management Rail (suffix ...F) Acrylic System Screens with or without Management Rail (suffix ...A) MFC System Screens without Management Rail (suffix ...MFC) MFC System Screens with Management Rail (suffix .../MFC)
------------------	---



ESS16F

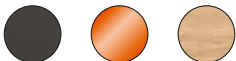

Fabric, Acrylic and MFC Finishes

Linnea Elevate Desk Mounted System Screen for Single Workstations

- Standard lead time.
- Straight dividing screens with aluminium trim and optional management rail.
- All screens suitable for screen mounted accessories.
- Screen is bracketed to the outer edge of the desk top.
- Link post not required.
- Available as Hygiene Protection Screens and add-ons (see HPS Guide).
- Optional screen mounted accessories available (page 293).

Straight System Screen

- ESS18...** - 1773w x 27d x 375h
- ESS16...** - 1573w x 27d x 375h
- ESS14...** - 1373w x 27d x 375h
- ESS12...** - 1173w x 27d x 375h

Straight System Screen with Management Rail

- ESS18M...** - 1773w x 27d x 375h
- ESS16M...** - 1573w x 27d x 375h
- ESS14M...** - 1373w x 27d x 375h
- ESS12M...** - 1173w x 27d x 375h

Finishes:	Fabric System Screens with or without Management Rail (suffix ...F) Acrylic System Screens with or without Management Rail (suffix ...A) MFC System Screens without Management Rail (suffix ...MFC) MFC System Screens with Management Rail (suffix .../MFC)
------------------	---

For use **without** Power Modules and Monitor Arms with brackets (no suffix)

For use **with** Power Modules and Monitor Arms with brackets (creates a minimum 12mm void) (suffix .../V)

Linnea Elevate

Desk Mounted Acoustic Screens

Fabric: Fully upholstered with pinnable surface - See below for pricing groups

Fabric Groups: Group 1 - Add surcharge for Group 2-7



ALESS16F



Fabric Finish

Linnea Elevate Desk Mounted Acoustic Screen for Double Benches

- Standard lead time.
- Straight dividing screens faced with 6mm polyester fibre insulation board.
- Screen is bracketed to the double bench leg frames.
- Link post not required.
- Class B certified in accordance with International Standards: ISO 354:2003, ISO 11654:1997 and ISO 9613-1:1993
- Available as Hygiene Protection Screens and add-ons (see HPS Guide).

Straight Acoustic Screen

ALESS18F - 1707w x 38d x 550h

ALESS16F - 1507w x 38d x 550h

ALESS14F - 1307w x 38d x 550h

ALESS12F - 1107w x 38d x 550h



AESS16F



Fabric Finish

Linnea Elevate Desk Mounted Acoustic Screen for Single Workstations

- Standard lead time.
- Straight dividing screens faced with 6mm polyester fibre insulation board.
- Screen is bracketed to the outer edge of the desk top.
- Link post not required.
- Class B certified in accordance with International Standards: ISO 354:2003, ISO 11654:1997 and ISO 9613-1:1993
- Available as Hygiene Protection Screens and add-ons (see HPS Guide).

Straight Acoustic Screen

AESS18F - 1773w x 38d x 375h

AESS16F - 1573w x 38d x 375h

AESS14F - 1373w x 38d x 375h

AESS12F - 1173w x 38d x 375h

Compatibility: For use *without* Power Modules and Monitor Arms with brackets (no suffix)
For use *with* Power Modules and Monitor Arms with brackets (creates a minimum 12mm void) (suffix **.../V**)

Lux

Fixed Height Workstations, Meeting, High Benches and Screens



Central to its design is the creation of an elegant, contemporary bench with tapered wooden legs and a cleverly engineered steel sub frame. Lux provides the perfect solution for a less corporate, modern office, dining, conference or breakout area. The range is available in a number of sizes, shapes and wood finishes providing a flexible product for many working spaces.



MFC:	Available in Ash, Autumn Cherry, Beech, Chester Oak, English Walnut, Grey, Grey Nebraska Oak, Laurentii Wenge, Natural Nebraska Oak and White
Veneer:	Available in Oak and Walnut (<i>3 Week Lead Time</i>)
Edging:	Add surcharge for Wenge, Black and Plywood Effect per top - <i>Edging on 25mm White MFC only</i>
Metalwork:	Silver, Black Graphite and White
Additional:	Standard corners (no suffix) - Add surcharge for radiused corners (suffix <i>.../RC</i> (page 46))



LUXB16/16/ASL



LUXB20/16/ASL

Lux Fixed Height Double Bench

- 2 week lead time.
- For how to specify, see page 44.
- 25mm top panel.
- Complete with horizontal cable trays.
- Tapered legs with adjustable levelling feet and steel sub-frame.
- Available with radiused corners (see 'Additional' above).

LUXB28/16...	- 1x Section	- 4x Slots	- 2800w x 1600d x 740h
LUXB26/16...	- 1x Section	- 4x Slots	- 2600w x 1600d x 740h
LUXB24/16...	- 1x Section	- 4x Slots	- 2400w x 1600d x 740h
LUXB22/16...	- 1x Section	- 4x Slots	- 2200w x 1600d x 740h
LUXB20/16...	- 1x Section	- 2x Slots	- 2000w x 1600d x 740h
LUXB18/16...	- 1x Section	- 2x Slots	- 1800w x 1600d x 740h
LUXB16/16...	- 1x Section	- 2x Slots	- 1600w x 1600d x 740h
LUXB14/16...	- 1x Section	- 2x Slots	- 1400w x 1600d x 740h

LUXB28/14...	- 1x Section	- 4x Slots	- 2800w x 1400d x 740h
LUXB26/14...	- 1x Section	- 4x Slots	- 2600w x 1400d x 740h
LUXB24/14...	- 1x Section	- 4x Slots	- 2400w x 1400d x 740h
LUXB22/14...	- 1x Section	- 4x Slots	- 2200w x 1400d x 740h
LUXB20/14...	- 1x Section	- 2x Slots	- 2000w x 1400d x 740h
LUXB18/14...	- 1x Section	- 2x Slots	- 1800w x 1400d x 740h
LUXB16/14...	- 1x Section	- 2x Slots	- 1600w x 1400d x 740h
LUXB14/14...	- 1x Section	- 2x Slots	- 1400w x 1400d x 740h

LUXB28/12...	- 1x Section	- 4x Slots	- 2800w x 1200d x 740h
LUXB26/12...	- 1x Section	- 4x Slots	- 2600w x 1200d x 740h
LUXB24/12...	- 1x Section	- 4x Slots	- 2400w x 1200d x 740h
LUXB22/12...	- 1x Section	- 4x Slots	- 2200w x 1200d x 740h
LUXB20/12...	- 1x Section	- 2x Slots	- 2000w x 1200d x 740h
LUXB18/12...	- 1x Section	- 2x Slots	- 1800w x 1200d x 740h
LUXB16/12...	- 1x Section	- 2x Slots	- 1600w x 1200d x 740h
LUXB14/12...	- 1x Section	- 2x Slots	- 1400w x 1200d x 740h

Finishes: Ash (.../ASL) Legs
 Add surcharge for Stained Walnut (.../WAL), Stained Espresso (.../ESL), Stained Wenge (.../WEL),
 Stained Grey (.../GYL), Stained Black (.../BKL) and White (.../WHL) Legs



MFC:	Available in Ash, Autumn Cherry, Beech, Chester Oak, English Walnut, Grey, Grey Nebraska Oak, Laurentii Wenge, Natural Nebraska Oak and White
Veneer:	Available in Oak and Walnut (3 Week Lead Time)
Edging:	Add surcharge for Wenge, Black and Plywood Effect per top - Edging on 25mm White MFC only
Metalwork:	Silver, Black Graphite and White
Additional:	Standard corners (no suffix) - Add surcharge for radiused corners (suffix .../RC (page 46))

How to Specify Lux Combined Double Benches

'Lux Combined Double Benches' can be added to which allows for any number of positions required in a single run. Simply specify a 'Lux Combined Double Bench' and add any number of 'Lux Combined Double Benches with Shared Legs' which will be positioned in the middle of the 'Lux Combined Double Bench'.

To add radius corners to the run of benches, simply suffix **.../RC** to either the 'Lux Double Bench' or the 'Lux Combined Double Bench'. The radius corners do not apply to the 'Combined Double Bench with Shared Leg' as they will always be used in the middle of a run. **See page 46.**

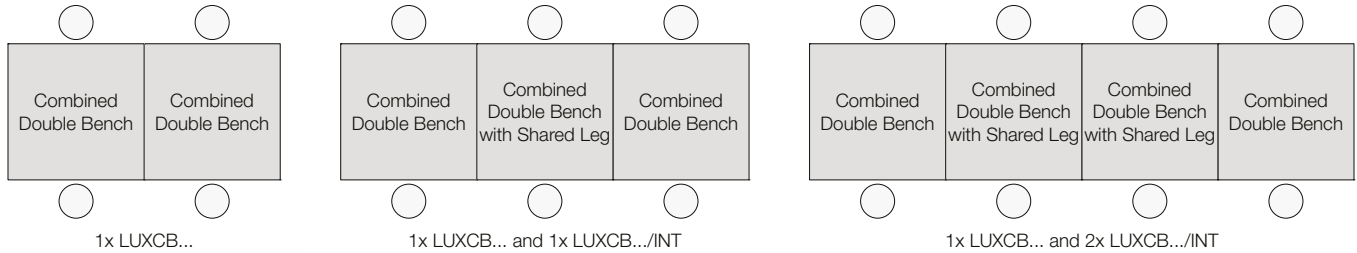

LUXCB32/16/ASL



LUXCB44/16/ASL

Lux Combined Double Bench

- 2 week lead time.
- For how to specify, **see above.**
- 2x 25mm top panels.
- Complete with horizontal cable trays.
- Tapered legs with adjustable levelling feet and steel sub-frame.
- Available with radiused corners (**see 'Additional'** above).

LUXCB56/16...	- 2x Sections	- 8x Slots	- 5600w x 1600d x 740h
LUXCB52/16...	- 2x Sections	- 8x Slots	- 5200w x 1600d x 740h
LUXCB48/16...	- 2x Sections	- 8x Slots	- 4800w x 1600d x 740h
LUXCB44/16...	- 2x Sections	- 8x Slots	- 4400w x 1600d x 740h
LUXCB40/16...	- 2x Sections	- 4x Slots	- 4000w x 1600d x 740h
LUXCB36/16...	- 2x Sections	- 4x Slots	- 3600w x 1600d x 740h
LUXCB32/16...	- 2x Sections	- 4x Slots	- 3200w x 1600d x 740h
LUXCB28/16...	- 2x Sections	- 4x Slots	- 2800w x 1600d x 740h

LUXCB56/14...	- 2x Sections	- 8x Slots	- 5600w x 1400d x 740h
LUXCB52/14...	- 2x Sections	- 8x Slots	- 5200w x 1400d x 740h
LUXCB48/14...	- 2x Sections	- 8x Slots	- 4800w x 1400d x 740h
LUXCB44/14...	- 2x Sections	- 8x Slots	- 4400w x 1400d x 740h
LUXCB40/14...	- 2x Sections	- 4x Slots	- 4000w x 1400d x 740h
LUXCB36/14...	- 2x Sections	- 4x Slots	- 3600w x 1400d x 740h
LUXCB32/14...	- 2x Sections	- 4x Slots	- 3200w x 1400d x 740h
LUXCB28/14...	- 2x Sections	- 4x Slots	- 2800w x 1400d x 740h

LUXCB56/12...	- 2x Sections	- 8x Slots	- 5600w x 1200d x 740h
LUXCB52/12...	- 2x Sections	- 8x Slots	- 5200w x 1200d x 740h
LUXCB48/12...	- 2x Sections	- 8x Slots	- 4800w x 1200d x 740h
LUXCB44/12...	- 2x Sections	- 8x Slots	- 4400w x 1200d x 740h
LUXCB40/12...	- 2x Sections	- 4x Slots	- 4000w x 1200d x 740h
LUXCB36/12...	- 2x Sections	- 4x Slots	- 3600w x 1200d x 740h
LUXCB32/12...	- 2x Sections	- 4x Slots	- 3200w x 1200d x 740h
LUXCB28/12...	- 2x Sections	- 4x Slots	- 2800w x 1200d x 740h

Finishes:

Ash (.../ASL) Legs

Add surcharge for Stained Walnut (.../WAL), Stained Espresso (.../ESL), Stained Wenge (.../WEL), Stained Grey (.../GYL), Stained Black (.../BKL) and White (.../WHL) Legs

MFC:	Available in Ash, Autumn Cherry, Beech, Chester Oak, English Walnut, Grey, Grey Nebraska Oak, Laurentii Wenge, Natural Nebraska Oak and White
Veneer:	Available in Oak and Walnut (3 Week Lead Time)
Edging:	Add surcharge for Wenge, Black and Plywood Effect per top - Edging on 25mm White MFC only
Metalwork:	Silver, Black Graphite and White
Additional:	Standard corners (no suffix) - Add surcharge for radiused corners (suffix .../RC (page 46))



LUXCB16/16/INT/ASL



LUXCB22/16/INT/ASL

Lux Combined Double Bench with Shared Intermediate Leg

- 2 week lead time. • For how to specify, see page 44. • 25mm top panel.
- Complete with horizontal cable trays.
- Tapered legs with adjustable levelling feet and steel sub-frame.

LUXCB28/16/INT...	- 1x Section - 4x Slots - 2800w x 1600d x 740h
LUXCB26/16/INT...	- 1x Section - 4x Slots - 2600w x 1600d x 740h
LUXCB24/16/INT...	- 1x Section - 4x Slots - 2400w x 1600d x 740h
LUXCB22/16/INT...	- 1x Section - 4x Slots - 2200w x 1600d x 740h
LUXCB20/16/INT...	- 1x Section - 2x Slots - 2000w x 1600d x 740h
LUXCB18/16/INT...	- 1x Section - 2x Slots - 1800w x 1600d x 740h
LUXCB16/16/INT...	- 1x Section - 2x Slots - 1600w x 1600d x 740h
LUXCB14/16/INT...	- 1x Section - 2x Slots - 1400w x 1600d x 740h

LUXCB28/14/INT...	- 1x Section - 4x Slots - 2800w x 1400d x 740h
LUXCB26/14/INT...	- 1x Section - 4x Slots - 2600w x 1400d x 740h
LUXCB24/14/INT...	- 1x Section - 4x Slots - 2400w x 1400d x 740h
LUXCB22/14/INT...	- 1x Section - 4x Slots - 2200w x 1400d x 740h
LUXCB20/14/INT...	- 1x Section - 2x Slots - 2000w x 1400d x 740h
LUXCB18/14/INT...	- 1x Section - 2x Slots - 1800w x 1400d x 740h
LUXCB16/14/INT...	- 1x Section - 2x Slots - 1600w x 1400d x 740h
LUXCB14/14/INT...	- 1x Section - 2x Slots - 1400w x 1400d x 740h

LUXCB28/12/INT...	- 1x Section - 4x Slots - 2800w x 1200d x 740h
LUXCB26/12/INT...	- 1x Section - 4x Slots - 2600w x 1200d x 740h
LUXCB24/12/INT...	- 1x Section - 4x Slots - 2400w x 1200d x 740h
LUXCB22/12/INT...	- 1x Section - 4x Slots - 2200w x 1200d x 740h
LUXCB20/12/INT...	- 1x Section - 2x Slots - 2000w x 1200d x 740h
LUXCB18/12/INT...	- 1x Section - 2x Slots - 1800w x 1200d x 740h
LUXCB16/12/INT...	- 1x Section - 2x Slots - 1600w x 1200d x 740h
LUXCB14/12/INT...	- 1x Section - 2x Slots - 1400w x 1200d x 740h

Finishes: Ash (.../ASL) Legs
 Add surcharge for Stained Walnut (.../WAL), Stained Espresso (.../ESL), Stained Wenge (.../WEL),
 Stained Grey (.../GYL), Stained Black (.../BKL) and White (.../WHL) Legs



LUXR16/8/ASL

Lux Rectangular Desk

- 2 week lead time. • 25mm top panel with 2x cable ports.
- Tapered legs with adjustable levelling feet and steel sub-frame.
- Available with radiused corners (see 'Additional' above).

LUXR20/10...	- 1x Section - 2000w x 1000d x 740h
LUXR18/10...	- 1x Section - 1800w x 1000d x 740h
LUXR16/10...	- 1x Section - 1600w x 1000d x 740h
LUXR14/10...	- 1x Section - 1400w x 1000d x 740h
LUXR12/10...	- 1x Section - 1200w x 1000d x 740h
LUXR10/10...	- 1x Section - 1000w x 1000d x 740h

LUXR20/8...	- 1x Section - 2000w x 800d x 740h
LUXR18/8...	- 1x Section - 1800w x 800d x 740h
LUXR16/8...	- 1x Section - 1600w x 800d x 740h
LUXR14/8...	- 1x Section - 1400w x 800d x 740h
LUXR12/8...	- 1x Section - 1200w x 800d x 740h
LUXR10/8...	- 1x Section - 1000w x 800d x 740h

LUXR20/6...	- 1x Section - 2000w x 600d x 740h
LUXR18/6...	- 1x Section - 1800w x 600d x 740h
LUXR16/6...	- 1x Section - 1600w x 600d x 740h
LUXR14/6...	- 1x Section - 1400w x 600d x 740h
LUXR12/6...	- 1x Section - 1200w x 600d x 740h
LUXR10/6...	- 1x Section - 1000w x 600d x 740h

Finishes: Ash (.../ASL) Legs
 Add surcharge for Stained Walnut (.../WAL), Stained Espresso (.../ESL), Stained Wenge (.../WEL),
 Stained Grey (.../GYL), Stained Black (.../BKL) and White (.../WHL) Legs

Metalwork: Silver, Black Graphite and White



LUXB16/16/ASL/RC

Lux Optional Radiused Corners

- 2 week lead time.
- Adds a radius to 4 corners of specific Lux workstations.
- Suffix **.../RC** to the end of relevant Lux codes.

.../RC - Radiused Corners



LUXRMP16
Illustrated in red

Lux Steel Modesty Panel

- Standard lead times.
- Modesty panels are 320mm high.

- LUXRMP20** - For 2000w Workstations - 1560w
- LUXRMP18** - For 1800w Workstations - 1360w
- LUXRMP16** - For 1600w Workstations - 1160w
- LUXRMP14** - For 1400w Workstations - 960w
- LUXRMP12** - For 1200w Workstations - 760w
- LUXRMP10** - For 1000w Workstations - 560w

Lux Featured Compatible Items



Lux CPU Holder

- Includes Lux mounting kit.

LUXCPU (Black)
LUXCPU/W (White)

See page 310 for details.



Maya Monitor Arm

- Clamp On and Bolt Through Desk Fixings.

MMA1/W (White)
MMA1/B (Black)

See page 306 for details.



Maya Dual Monitor Arm

- Clamp On and Bolt Through Desk Fixings.

MMA2/W (White)
MMA2/B (Black)

See page 306 for details.



Maya Laptop Stand

- Attaches onto Maya Monitor Arms.

MMA/LS/B (Black)

See page 306 for details.



Slinky Cable Riser

- Suitable for all desk ranges.

SCR/S (Silver)
SCR/B (Black)
SCR/W (White)

See page 310 for details.

Lux Compatibility Breakdown

- **Black** - Compatible
- **Purple** - Conflict when using cable tray
- **Red** - May not support larger modules

- Lux** - Double Benches
- Lux** - Rectangular
- Lux** - 1000w Circular Meeting
- Lux** - All other Conference / Meeting
- Lux** - Benches

	Kaspa, page 294	Prime, page 294	Boardroom, page 295	Conus, page 296	Peak, page 297	Escalate, page 297	Wireless Charging Unit, page 298	Port Hole, page 299	Pix, page 299	Pluto, page 300	Inca, page 300	Flex, page 301	Boost, page 301	Capsule, page 302	Plaza, page 303	Wieland Socket Boxes, page 303
Lux - Double Benches						●	●	●	●			●		●		●
Lux - Rectangular	●	●				●	●	●	●	●	●	●	●	●	●	●
Lux - 1000w Circular Meeting	●	●	●	●	●	●	●	●	●	●	●	●	●	●	●	●
Lux - All other Conference / Meeting	●	●	●	●	●	●	●	●	●	●	●	●	●	●	●	●
Lux - Benches	●	●	●	●	●	●	●	●	●	●	●	●	●	●	●	●

MFC:	Available in Ash, Autumn Cherry, Beech, Chester Oak, English Walnut, Grey, Grey Nebraska Oak, Laurentii Wenge, Natural Nebraska Oak and White
Veneer:	Available in Oak and Walnut (3 Week Lead Time)
Edging:	Add surcharge for Wenge, Black and Plywood Effect per top - Edging on 25mm White MFC only
Metalwork:	Silver, Black Graphite and White
Additional:	Standard corners (no suffix) - Add surcharge for radiused corners (suffix .../RC (page 46))



LUXOCT2800/ASL

Lux Octagonal Conference Table

- 2 week lead time.
- 25mm top panel.
- Tapered legs with adjustable levelling feet and steel sub-frame.

LUXOCT2800... - 2800w x 1200d x 740h
1x 2800mm Section - Seating up to 10 People

LUXOCT2600... - 2600w x 1200d x 740h
1x 2600mm Section - Seating up to 8 People

LUXOCT2400... - 2400w x 1000d x 740h
1x 2400mm Section - Seating up to 8 People

Finishes: Ash (.../ASL) Legs
Add surcharge for Stained Walnut (.../WAL), Stained Espresso (.../ESL), Stained Wenge (.../WEL), Stained Grey (.../GYL), Stained Black (.../BKL) and White (.../WHL) Legs



LUXMT32/12/ASL

Lux Rectangular Meeting Table

- 2 week lead time.
- 2x 25mm top panels.
- Tapered legs with adjustable levelling feet and steel sub-frame.
- Available with radiused corners (see 'Additional' above).

LUXMT48/16... - 2x Sections - 4800w x 1600d x 740h
LUXMT44/16... - 2x Sections - 4400w x 1600d x 740h
LUXMT40/16... - 2x Sections - 4000w x 1600d x 740h
LUXMT36/16... - 2x Sections - 3600w x 1600d x 740h
LUXMT32/16... - 2x Sections - 3200w x 1600d x 740h
LUXMT30/16... - 2x Sections - 3000w x 1600d x 740h

LUXMT48/14... - 2x Sections - 4800w x 1400d x 740h
LUXMT44/14... - 2x Sections - 4400w x 1400d x 740h
LUXMT40/14... - 2x Sections - 4000w x 1400d x 740h
LUXMT36/14... - 2x Sections - 3600w x 1400d x 740h
LUXMT32/14... - 2x Sections - 3200w x 1400d x 740h
LUXMT30/14... - 2x Sections - 3000w x 1400d x 740h

LUXMT48/12... - 2x Sections - 4800w x 1200d x 740h
LUXMT44/12... - 2x Sections - 4400w x 1200d x 740h
LUXMT40/12... - 2x Sections - 4000w x 1200d x 740h
LUXMT36/12... - 2x Sections - 3600w x 1200d x 740h
LUXMT32/12... - 2x Sections - 3200w x 1200d x 740h
LUXMT30/12... - 2x Sections - 3000w x 1200d x 740h

LUXMT48/10... - 2x Sections - 4800w x 1000d x 740h
LUXMT44/10... - 2x Sections - 4400w x 1000d x 740h
LUXMT40/10... - 2x Sections - 4000w x 1000d x 740h
LUXMT36/10... - 2x Sections - 3600w x 1000d x 740h
LUXMT32/10... - 2x Sections - 3200w x 1000d x 740h
LUXMT30/10... - 2x Sections - 3000w x 1000d x 740h

Finishes: Ash (.../ASL) Legs
Add surcharge for Stained Walnut (.../WAL), Stained Espresso (.../ESL), Stained Wenge (.../WEL), Stained Grey (.../GYL), Stained Black (.../BKL) and White (.../WHL) Legs

MFC:	Available in Ash, Autumn Cherry, Beech, Chester Oak, English Walnut, Grey, Grey Nebraska Oak, Laurentii Wenge, Natural Nebraska Oak and White
Veneer:	Available in Oak and Walnut (<i>3 Week Lead Time</i>)
Edging:	Add surcharge for Wenge, Black and Plywood Effect per top - <i>Edging on 25mm White MFC only</i>
Metalwork:	Silver, Black Graphite and White
Additional:	Standard corners (no suffix) - Add surcharge for radiused corners (suffix <i>.../RC</i> (page 46))



LUXMT16/12/ASL

Lux Rectangular Meeting Table

- 2 week lead time.
- 25mm top panel.
- Tapered legs with adjustable levelling feet and steel sub-frame.
- Available with radiused corners (see 'Additional' above).

LUXMT28/16...	- 1x Section - 2800w x 1600d x 740h
LUXMT26/16...	- 1x Section - 2600w x 1600d x 740h
LUXMT24/16...	- 1x Section - 2400w x 1600d x 740h
LUXMT22/16...	- 1x Section - 2200w x 1600d x 740h
LUXMT20/16...	- 1x Section - 2000w x 1600d x 740h
LUXMT18/16...	- 1x Section - 1800w x 1600d x 740h

LUXMT28/14...	- 1x Section - 2800w x 1400d x 740h
LUXMT26/14...	- 1x Section - 2600w x 1400d x 740h
LUXMT24/14...	- 1x Section - 2400w x 1400d x 740h
LUXMT22/14...	- 1x Section - 2200w x 1400d x 740h
LUXMT20/14...	- 1x Section - 2000w x 1400d x 740h
LUXMT18/14...	- 1x Section - 1800w x 1400d x 740h
LUXMT16/14...	- 1x Section - 1600w x 1400d x 740h

LUXMT28/12...	- 1x Section - 2800w x 1200d x 740h
LUXMT26/12...	- 1x Section - 2600w x 1200d x 740h
LUXMT24/12...	- 1x Section - 2400w x 1200d x 740h
LUXMT22/12...	- 1x Section - 2200w x 1200d x 740h
LUXMT20/12...	- 1x Section - 2000w x 1200d x 740h
LUXMT18/12...	- 1x Section - 1800w x 1200d x 740h
LUXMT16/12...	- 1x Section - 1600w x 1200d x 740h
LUXMT14/12...	- 1x Section - 1400w x 1200d x 740h

LUXMT28/10...	- 1x Section - 2800w x 1000d x 740h
LUXMT26/10...	- 1x Section - 2600w x 1000d x 740h
LUXMT24/10...	- 1x Section - 2400w x 1000d x 740h
LUXMT22/10...	- 1x Section - 2200w x 1000d x 740h
LUXMT20/10...	- 1x Section - 2000w x 1000d x 740h
LUXMT18/10...	- 1x Section - 1800w x 1000d x 740h
LUXMT16/10...	- 1x Section - 1600w x 1000d x 740h
LUXMT14/10...	- 1x Section - 1400w x 1000d x 740h
LUXMT12/10...	- 1x Section - 1200w x 1000d x 740h

Finishes: Ash (.../ASL) Legs
 Add surcharge for Stained Walnut (.../WAL), Stained Espresso (.../ESL), Stained Wenge (.../WEL), Stained Grey (.../GYL), Stained Black (.../BKL) and White (.../WHL) Legs



LUXMT16/16/ASL

Lux Square Meeting Table

- 2 week lead time.
- 25mm top panel.
- Tapered legs with adjustable levelling feet and steel sub-frame.
- Available with radiused corners (see 'Additional' above).

LUXMT20/20...	- 2000w x 2000d x 740h
LUXMT18/18...	- 1800w x 1800d x 740h
LUXMT16/16...	- 1600w x 1600d x 740h
LUXMT14/14...	- 1400w x 1400d x 740h
LUXMT12/12...	- 1200w x 1200d x 740h
LUXMT10/10...	- 1000w x 1000d x 740h

Finishes: Ash (.../ASL) Legs
 Add surcharge for Stained Walnut (.../WAL), Stained Espresso (.../ESL), Stained Wenge (.../WEL), Stained Grey (.../GYL), Stained Black (.../BKL) and White (.../WHL) Legs

MFC: Available in Ash, Autumn Cherry, Beech, Chester Oak, English Walnut, Grey, Grey Nebraska Oak, Laurentii Wenge, Natural Nebraska Oak and White
Veneer: Available in Oak and Walnut (3 Week Lead Time)
Edging: Add surcharge for Wenge, Black and Plywood Effect per top - Edging on 25mm White MFC only
Metalwork: Silver, Black Graphite and White



LUXMT/CIR16/ASL

Lux Circular Meeting Table

- 2 week lead time.
- 25mm top panel.
- Tapered legs with adjustable levelling feet and steel sub-frame.

LUXMT/CIR20... - 2000w (dia) x 740h
LUXMT/CIR18... - 1800w (dia) x 740h
LUXMT/CIR16... - 1600w (dia) x 740h
LUXMT/CIR14... - 1400w (dia) x 740h
LUXMT/CIR12... - 1200w (dia) x 740h
LUXMT/CIR10... - 1000w (dia) x 740h

Finishes:

Ash (.../ASL) Legs
 Add surcharge for Stained Walnut (.../WAL), Stained Espresso (.../ESL), Stained Wenge (.../WEL),
 Stained Grey (.../GYL), Stained Black (.../BKL) and White (.../WHL) Legs



MFC:	Available in Ash, Autumn Cherry, Beech, Chester Oak, English Walnut, Grey, Grey Nebraska Oak, Laurentii Wenge, Natural Nebraska Oak and White
Veneer:	Available in Oak and Walnut (3 Week Lead Time)
Edging:	Add surcharge for Wenge, Black and Plywood Effect per top - Edging on 25mm White MFC only
Metalwork:	Silver, Black Graphite and White
Additional:	Standard corners (no suffix) - Add surcharge for radiused corners (suffix .../RC (page 46))



LUXHB32/12/ASL

Lux High Bench Table

- 2 week lead time.
- 2x 25mm top panels.
- Tapered legs with adjustable levelling feet and steel sub-frame.
- Available with radiused corners (see 'Additional' above).

LUXHB40/12...	- 2x Sections	- 4000w x 1200d x 1050h
LUXHB36/12...	- 2x Sections	- 3600w x 1200d x 1050h
LUXHB32/12...	- 2x Sections	- 3200w x 1200d x 1050h
LUXHB30/12...	- 2x Sections	- 3000w x 1200d x 1050h

LUXHB40/10...	- 2x Sections	- 4000w x 1000d x 1050h
LUXHB36/10...	- 2x Sections	- 3600w x 1000d x 1050h
LUXHB32/10...	- 2x Sections	- 3200w x 1000d x 1050h
LUXHB30/10...	- 2x Sections	- 3000w x 1000d x 1050h

Finishes:

Ash (.../ASL) Legs

Add surcharge for Stained Walnut (.../WAL), Stained Espresso (.../ESL), Stained Wenge (.../WEL), Stained Grey (.../GYL), Stained Black (.../BKL) and White (.../WHL) Legs



LUXHB16/12/ASL

Lux High Bench Table

- 2 week lead time.
- 25mm top panel.
- Tapered legs with adjustable levelling feet and steel sub-frame.
- Available with radiused corners (see 'Additional' above).

LUXHB24/12...	- 1x Section	- 2400w x 1200d x 1050h
LUXHB22/12...	- 1x Section	- 2200w x 1200d x 1050h
LUXHB20/12...	- 1x Section	- 2000w x 1200d x 1050h
LUXHB18/12...	- 1x Section	- 1800w x 1200d x 1050h
LUXHB16/12...	- 1x Section	- 1600w x 1200d x 1050h
LUXHB14/12...	- 1x Section	- 1400w x 1200d x 1050h

LUXHB24/10...	- 1x Section	- 2400w x 1000d x 1050h
LUXHB22/10...	- 1x Section	- 2200w x 1000d x 1050h
LUXHB20/10...	- 1x Section	- 2000w x 1000d x 1050h
LUXHB18/10...	- 1x Section	- 1800w x 1000d x 1050h
LUXHB16/10...	- 1x Section	- 1600w x 1000d x 1050h
LUXHB14/10...	- 1x Section	- 1400w x 1000d x 1050h

Finishes:

Ash (.../ASL) Legs

Add surcharge for Stained Walnut (.../WAL), Stained Espresso (.../ESL), Stained Wenge (.../WEL), Stained Grey (.../GYL), Stained Black (.../BKL) and White (.../WHL) Legs

Lux

Accessories and Desk Mounted Acoustic Screens

Metalwork: Silver, Black Graphite and White
Fabric: Fully upholstered with pinnable surface - See below for pricing groups
Fabric Groups: Group 1 - Add surcharge for Group 2-7



LCTR16
Illustrated in red



LCTR16
Illustrated in red

Lux Cable Tray

- 2 week lead time. • Compatible with all Lux tables.
- High capacity cable management system neatly conceals power, data and telecom cables through a hinged cable management tray. • Cable trays are 230mm deep and 80mm high.

LCTO28	- For LUXOCT2800	- 1100w (2x)
LCTO26	- For LUXOCT2600	- 1000w (2x)
LCTO24	- For LUXOCT2400	- 900w (2x)
LCTR48	- For 4800w Rectangular Tables	- 900w (4x)
LCTR44	- For 4400w Rectangular Tables	- 800w (4x)
LCTR40	- For 4000w Rectangular and High Bench Tables	- 1500w (2x)
LCTR36	- For 3600w Rectangular and High Bench Tables	- 1300w (2x)
LCTR32	- For 3200w Rectangular and High Bench Tables	- 1100w (2x)
LCTR30	- For 3000w Rectangular and High Bench Tables	- 1000w (2x)
LCTR28	- For 2800w Rectangular Tables	- 1100w (2x)
LCTR26	- For 2600w Rectangular Tables	- 1000w (2x)
LCTR24	- For 2400w Rectangular and High Bench Tables	- 900w (2x)
LCTR22	- For 2200w Rectangular and High Bench Tables	- 800w (2x)
LCTR20	- For 2000w Rectangular and High Bench Tables	- 1500w
LCTR18	- For 1800w Rectangular and High Bench Tables	- 1300w
LCTR16	- For 1600w Rectangular and High Bench Tables	- 1100w
LCTR14	- For 1400w Rectangular and High Bench Tables	- 900w
LCTR12	- For 1200w Rectangular Tables	- 700w
LCTR10	- For 1000w Rectangular Tables	- 500w
LCTS20	- For 2000w Square Meeting	- 1500w
LCTS18	- For 1800w Square Meeting	- 1300w
LCTS16	- For 1600w Square Meeting	- 1100w
LCTS14	- For 1400w Square Meeting	- 900w
LCTS12	- For 1200w Square Meeting	- 700w
LCTS10	- For 1000w Square Meeting	- 500w
LCTC18	- For 2000w and 1800w Circular Meeting	- 900w
LCTC16	- For 1600w Circular Meeting	- 700w
LCTC14	- For 1400w Circular Meeting	- 600w
LCTC12	- For 1200w Circular Meeting	- 500w



AELUXSS1150F



Fabric Finish

Lux Desk Mounted Acoustic Screen for Double Benches

- Standard lead time. • Straight dividing screens faced with 6mm polyester fibre insulation board.
- Screen is bracketed to the double bench leg frames. • Link post not required.
- Class B certified in accordance with International Standards: ISO 354:2003, ISO 11654:1997 and ISO 9613-1:1993
- Available as Hygiene Protection Screens and add-ons (see HPS Guide).

Straight Acoustic Screen

AELUXSS1750F	- For 2200w Sections	- 1750w x 38d x 375h
AELUXSS1550F	- For 2000w Sections	- 1550w x 38d x 375h
AELUXSS1350F	- For 1800w Sections	- 1350w x 38d x 375h
AELUXSS1150F	- For 1600w Sections	- 1150w x 38d x 375h
AELUXSS950F	- For 1400w Sections or 2x Screens per 2800w Sections	- 950w x 38d x 375h
AELUXSS850F	- 2x Screens per 2600w Sections	- 850w x 38d x 375h
AELUXSS750F	- 2x Screens per 2400w Sections	- 750w x 38d x 375h

Reflex

Fixed Height Workstations and Meeting



A sleek and elegantly angled leg frame defines the clean lines of the Reflex range giving a contemporary, executive appearance. The legs connect to a full steel sub-frame for maximum strength and stability. An optional horizontal and vertical wire management solution can be added to house cables, leaving the area free from trailing wires. Angled modesty panels are compatible with Reflex desking, adding an element of privacy and complementing the angles of the leg frame.



Reflex

Fixed Height Workstations and Accessories

2 Week Lead Time

MFC: Available in Ash, Autumn Cherry, Beech, Chester Oak, English Walnut, Grey, Grey Nebraska Oak, Laurentii Wenge, Natural Nebraska Oak and White
Veneer: Available in Oak and Walnut (3 Week Lead Time)
Edging: Add surcharge for Wenge, Black and Plywood Effect per top - Edging on 25mm White MFC only
Metalwork: Silver, Black Graphite and White - Add surcharge for Chrome Effect and Raw



RR16/8

Reflex Rectangular Desk

- 2 week lead time.
- 25mm top panel.
- Tapered angled legs with steel sub-frame.
- Adjustable levelling feet.

RR20/10 - 2000w x 1000d x 740h

RR18/10 - 1800w x 1000d x 740h

RR16/10 - 1600w x 1000d x 740h

RR20/8 - 2000w x 800d x 740h

RR18/8 - 1800w x 800d x 740h

RR16/8 - 1600w x 800d x 740h



RMA18/18RH

Reflex Managers Workstation

- 2 week lead time.
- 2x 25mm top panels.
- Tapered angled legs with steel sub-frame.
- Adjustable levelling feet.

RMA20/20... (LH or RH) - 2000w x 2000d x 740h

RMA18/20... (LH or RH) - 1800w x 2000d x 740h

RMA16/20... (LH or RH) - 1600w x 2000d x 740h

RMA20/18... (LH or RH) - 2000w x 1800d x 740h

RMA18/18... (LH or RH) - 1800w x 1800d x 740h

RMA16/18... (LH or RH) - 1600w x 1800d x 740h



RMP16
Illustrated in red

Reflex Steel Modesty Panel

- 2 week lead time.
- Modesty panels are 320mm high.

RMP20 - For 2000w Workstations - 1560w

RMP18 - For 1800w Workstations - 1360w

RMP16 - For 1600w Workstations - 1160w



RCR
Illustrated in red

Reflex Cable Riser

- 2 week lead time.
- Compatible with all Reflex workstation legs.
- Can be retrofitted.
- Capacity to vertically enclose 1x 12mm diameter power cable.

RCR



RCT16
Illustrated in red

Reflex Cable Tray

- 2 week lead time.
- Compatible with all Reflex desks and workstations.
- High capacity cable management system neatly conceals power, data and telecom cables through a hinged cable management tray.
- Cable trays are 132mm deep and 100mm high.

RCT20 - For 2000w Workstations - 1410w

RCT18 - For 1800w Workstations - 1210w

RCT16 - For 1600w Workstations - 1010w

MFC: Available in Ash, Autumn Cherry, Beech, Chester Oak, English Walnut, Grey, Grey Nebraska Oak, Laurentii Wenge, Natural Nebraska Oak and White
Veneer: Available in Oak and Walnut (3 Week Lead Time)
Edging: Add surcharge for Wenge, Black and Plywood Effect per top - Edging on 25mm White MFC only
Metalwork: Silver, Black Graphite and White - Add surcharge for Chrome Effect and Raw
 Add surcharge for Praline, Olive Green, Atlantic Blue, Sapphire Blue, Mustard Yellow, Terracotta and Conker Brown (2 Week Lead Time)

Reflex Compatibility Breakdown

- **Black** - Compatible
- **Blue** - Conflict when using screens without .../V
- **Purple** - Conflict when using cable tray
- **Green** - Unspecified
- **Red** - May not support larger modules

- Reflex - Rectangular and Managers
- Reflex - 1000w Circular Meeting
- Reflex - All other Conference / Meeting

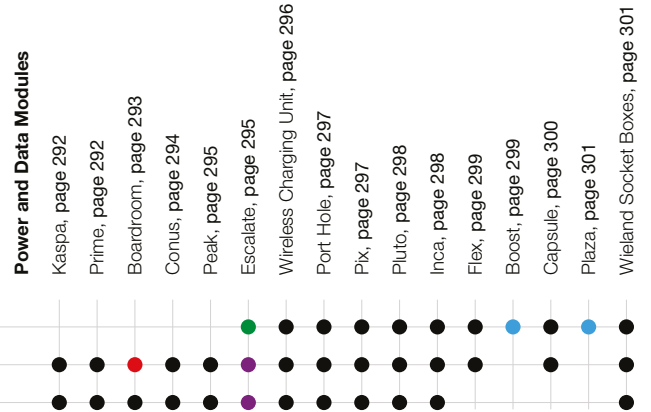

ROCT3000

Reflex Octagonal Conference Table

- 2 week lead time.
- 25mm top panel.
- Shared centre legs.
- Tapered angled legs with steel sub-frame.
- Adjustable levelling feet.

ROCT3000 - 3000w x 1400d x 740h
 1x 3000mm Section - Seating up to 10 People



ROCT2800

Reflex Octagonal Conference Table

- 2 week lead time.
- 25mm top panel.
- Tapered angled legs with steel sub-frame.
- Adjustable levelling feet.

ROCT2800 - 2800w x 1200d x 740h
 1x 2800mm Section - Seating up to 10 People

ROCT2600 - 2600w x 1200d x 740h
 1x 2600mm Section - Seating up to 8 People

ROCT2400 - 2400w x 1000d x 740h
 1x 2400mm Section - Seating up to 8 People



MFC: Available in Ash, Autumn Cherry, Beech, Chester Oak, English Walnut, Grey, Grey Nebraska Oak, Laurentii Wenge, Natural Nebraska Oak and White
Veneer: Available in Oak and Walnut (3 Week Lead Time)
Edging: Add surcharge for Wenge, Black and Plywood Effect per top - Edging on 25mm White MFC only
Metalwork: Silver, Black Graphite and White - Add surcharge for Chrome Effect and Raw
 Add surcharge for Praline, Olive Green, Atlantic Blue, Sapphire Blue, Mustard Yellow, Terracotta and Conker Brown (2 Week Lead Time)



RMT32/12

Reflex Rectangular Meeting Table

- 2 week lead time.
- 2x 25mm top panels.
- Shared centre legs.
- Tapered angled legs with steel sub-frame.
- Adjustable levelling feet.

RMT48/14 - 2x Sections - 4800w x 1400d x 740h
RMT44/14 - 2x Sections - 4400w x 1400d x 740h
RMT40/14 - 2x Sections - 4000w x 1400d x 740h
RMT36/14 - 2x Sections - 3600w x 1400d x 740h
RMT32/14 - 2x Sections - 3200w x 1400d x 740h
RMT30/14 - 2x Sections - 3000w x 1400d x 740h

RMT48/12 - 2x Sections - 4800w x 1200d x 740h
RMT44/12 - 2x Sections - 4400w x 1200d x 740h
RMT40/12 - 2x Sections - 4000w x 1200d x 740h
RMT36/12 - 2x Sections - 3600w x 1200d x 740h
RMT32/12 - 2x Sections - 3200w x 1200d x 740h
RMT30/12 - 2x Sections - 3000w x 1200d x 740h

RMT48/10 - 2x Sections - 4800w x 1000d x 740h
RMT44/10 - 2x Sections - 4400w x 1000d x 740h
RMT40/10 - 2x Sections - 4000w x 1000d x 740h
RMT36/10 - 2x Sections - 3600w x 1000d x 740h
RMT32/10 - 2x Sections - 3200w x 1000d x 740h
RMT30/10 - 2x Sections - 3000w x 1000d x 740h



RMT16/12

Reflex Rectangular Meeting Table

- 2 week lead time.
- 25mm top panel.
- Tapered angled legs with steel sub-frame.
- Adjustable levelling feet.

RMT28/14 - 1x Section - 2800w x 1400d x 740h
RMT26/14 - 1x Section - 2600w x 1400d x 740h
RMT24/14 - 1x Section - 2400w x 1400d x 740h
RMT22/14 - 1x Section - 2200w x 1400d x 740h
RMT20/14 - 1x Section - 2000w x 1400d x 740h
RMT18/14 - 1x Section - 1800w x 1400d x 740h
RMT16/14 - 1x Section - 1600w x 1400d x 740h

RMT28/12 - 1x Section - 2800w x 1200d x 740h
RMT26/12 - 1x Section - 2600w x 1200d x 740h
RMT24/12 - 1x Section - 2400w x 1200d x 740h
RMT22/12 - 1x Section - 2200w x 1200d x 740h
RMT20/12 - 1x Section - 2000w x 1200d x 740h
RMT18/12 - 1x Section - 1800w x 1200d x 740h
RMT16/12 - 1x Section - 1600w x 1200d x 740h
RMT14/12 - 1x Section - 1400w x 1200d x 740h

RMT28/10 - 1x Section - 2800w x 1000d x 740h
RMT26/10 - 1x Section - 2600w x 1000d x 740h
RMT24/10 - 1x Section - 2400w x 1000d x 740h
RMT22/10 - 1x Section - 2200w x 1000d x 740h
RMT20/10 - 1x Section - 2000w x 1000d x 740h
RMT18/10 - 1x Section - 1800w x 1000d x 740h
RMT16/10 - 1x Section - 1600w x 1000d x 740h
RMT14/10 - 1x Section - 1400w x 1000d x 740h
RMT12/10 - 1x Section - 1200w x 1000d x 740h

Reflex

Meeting Tables and Accessories

MFC: Available in Ash, Autumn Cherry, Beech, Chester Oak, English Walnut, Grey, Grey Nebraska Oak, Laurentii Wenge, Natural Nebraska Oak and White
Veneer: Available in Oak and Walnut (3 Week Lead Time)
Edging: Add surcharge for Wenge, Black and Plywood Effect per top - Edging on 25mm White MFC only
Metalwork: Silver, Black Graphite and White - Add surcharge for Chrome Effect and Raw
 Add surcharge for Praline, Olive Green, Atlantic Blue, Sapphire Blue, Mustard Yellow, Terracotta and Conker Brown (2 Week Lead Time)



RMT16/16

Reflex Square Meeting Table

- 2 week lead time.
- 25mm top panel.
- Tapered angled legs with steel sub-frame.
- Adjustable levelling feet.

- RMT20/20** - 2000w x 2000d x 740h
- RMT18/18** - 1800w x 1800d x 740h
- RMT16/16** - 1600w x 1600d x 740h
- RMT14/14** - 1400w x 1400d x 740h
- RMT12/12** - 1200w x 1200d x 740h
- RMT10/10** - 1000w x 1000d x 740h



RMT/CIR16

Reflex Circular Meeting Table

- 2 week lead time.
- 25mm top panel.
- Tapered angled legs with steel sub-frame.
- Adjustable levelling feet.

- RMT/CIR20** - 2000w (dia) x 740h
- RMT/CIR18** - 1800w (dia) x 740h
- RMT/CIR16** - 1600w (dia) x 740h
- RMT/CIR14** - 1400w (dia) x 740h
- RMT/CIR12** - 1200w (dia) x 740h
- RMT/CIR10** - 1000w (dia) x 740h



LCTR16
Illustrated in red

Reflex Meeting Cable Tray

- 2 week lead time.
- Compatible with all Reflex conference / meeting tables.
- High capacity cable management system neatly conceals power, data and telecom cables through a hinged cable management tray.
- Cable trays are 230mm deep and 80mm high.

- LCTO30** - For ROCT3000 - 1200w (2x)
- LCTO28** - For ROCT2800 - 1100w (2x)
- LCTO26** - For ROCT2600 - 1000w (2x)
- LCTO24** - For ROCT2400 - 900w (2x)

- LCTR48** - For 4800w Rectangular Meeting - 900w (4x)
- LCTR44** - For 4400w Rectangular Meeting - 800w (4x)
- LCTR40** - For 4000w Rectangular Meeting - 1500w (2x)
- LCTR36** - For 3600w Rectangular Meeting - 1300w (2x)
- LCTR32** - For 3200w Rectangular Meeting - 1100w (2x)
- LCTR30** - For 3000w Rectangular Meeting - 1000w (2x)
- LCTR28** - For 2800w Rectangular Meeting - 1100w (2x)
- LCTR26** - For 2600w Rectangular Meeting - 1000w (2x)
- LCTR24** - For 2400w Rectangular Meeting - 900w (2x)
- LCTR22** - For 2200w Rectangular Meeting - 800w (2x)
- LCTR20** - For 2000w Rectangular Meeting - 1500w
- LCTR18** - For 1800w Rectangular Meeting - 1300w
- LCTR16** - For 1600w Rectangular Meeting - 1100w
- LCTR14** - For 1400w Rectangular Meeting - 900w
- LCTR12** - For 1200w Rectangular Meeting - 700w

- LCTS20** - For 2000w Square Meeting - 1500w
- LCTS18** - For 1800w Square Meeting - 1300w
- LCTS16** - For 1600w Square Meeting - 1100w
- LCTS14** - For 1400w Square Meeting - 900w
- LCTS12** - For 1200w Square Meeting - 700w
- LCTS10** - For 1000w Square Meeting - 500w

- LCTC18** - For 2000w and 1800w Circular Meeting - 900w
- LCTC16** - For 1600w Circular Meeting - 700w
- LCTC14** - For 1400w Circular Meeting - 600w
- LCTC12** - For 1200w Circular Meeting - 500w

Linnea

Fixed Height Workstations, Meeting and Screens



Linnea is a comprehensive range offering a variety of solutions for diverse applications. It is available with an angled or goalpost leg frame, supported by a steel sub-frame offering strength and stability. Shared legs are a feature of the Linnea range, minimising the number of legs required and increasing the useable space under the workstation. Double Benches are supplied with sliding tops and horizontal wire management trays as standard, with an optional sliding top locking device, should the user require the top to be locked in the open or closed position. Limited desktop height adjustment is an option via a Spacer Kit, enabling the workstation top to elevate in increments of 25mm starting at a standard desk height of 740mm to 765mm, 790mm, and 815mm.



Linnea

Fixed Height Workstations

MFC:	Available in Ash, Autumn Cherry, Beech, Chester Oak, English Walnut, Grey, Grey Nebraska Oak, Laurentii Wenge, Natural Nebraska Oak and White
Nanotech:	Available in Black (3 Week Lead Time)
Veneer:	Available in Oak and Walnut (3 Week Lead Time)
Edging:	Add surcharge for Wenge, Black and Plywood Effect per top - Edging on 25mm White MFC and Black Nanotech only
Metalwork:	Silver, Black Graphite and White - Add surcharge for Chrome Effect and Raw
Additional:	Standard legs (no suffix) - 90 degree legs (suffix .../90 (page 62))



L16/16

Linnea Double Bench

- Standard lead times. • 2x 25mm sliding top panels. • Complete with a central cable tray.
- Available with 90 degree Linnea leg (see 'Additional' above).
- 640h+ mobile pedestals will protrude with 1400d and 1200d double benches, as an alternative, use **MPF** and **MP3** pedestals (page 215).

L20/16	- 2000w x 1600d x 740h
L18/16	- 1800w x 1600d x 740h
L16/16	- 1600w x 1600d x 740h
L15/16	- 1500w x 1600d x 740h
L14/16	- 1400w x 1600d x 740h
L12/16	- 1200w x 1600d x 740h
L10/16	- 1000w x 1600d x 740h

L20/14	- 2000w x 1400d x 740h
L18/14	- 1800w x 1400d x 740h
L16/14	- 1600w x 1400d x 740h
L15/14	- 1500w x 1400d x 740h
L14/14	- 1400w x 1400d x 740h
L12/14	- 1200w x 1400d x 740h
L10/14	- 1000w x 1400d x 740h

L20/12	- 2000w x 1200d x 740h
L18/12	- 1800w x 1200d x 740h
L16/12	- 1600w x 1200d x 740h
L15/12	- 1500w x 1200d x 740h
L14/12	- 1400w x 1200d x 740h
L12/12	- 1200w x 1200d x 740h
L10/12	- 1000w x 1200d x 740h



L16/16/INT

Linnea Double Bench With Shared Inset Intermediate Leg

- Standard lead times. • 2x 25mm sliding top panels. • Complete with a central cable tray.
- Available with 90 degree Linnea leg (see 'Additional' above).
- 640h+ mobile pedestals will protrude with 1400d and 1200d double benches, as an alternative, use **MPF** and **MP3** pedestals (page 215).

L20/16/INT	- 2000w x 1600d x 740h
L18/16/INT	- 1800w x 1600d x 740h
L16/16/INT	- 1600w x 1600d x 740h
L15/16/INT	- 1500w x 1600d x 740h
L14/16/INT	- 1400w x 1600d x 740h
L12/16/INT	- 1200w x 1600d x 740h
L10/16/INT	- 1000w x 1600d x 740h

L20/14/INT	- 2000w x 1400d x 740h
L18/14/INT	- 1800w x 1400d x 740h
L16/14/INT	- 1600w x 1400d x 740h
L15/14/INT	- 1500w x 1400d x 740h
L14/14/INT	- 1400w x 1400d x 740h
L12/14/INT	- 1200w x 1400d x 740h
L10/14/INT	- 1000w x 1400d x 740h

L20/12/INT	- 2000w x 1200d x 740h
L18/12/INT	- 1800w x 1200d x 740h
L16/12/INT	- 1600w x 1200d x 740h
L15/12/INT	- 1500w x 1200d x 740h
L14/12/INT	- 1400w x 1200d x 740h
L12/12/INT	- 1200w x 1200d x 740h
L10/12/INT	- 1000w x 1200d x 740h



LPIN

Linnea Sliding Top Locking Pin for Double Benches

- Standard lead times. • Available in Silver finish only. • Located under bench top.
- A spring loaded locking pin allowing the double bench to be locked in open and closed positions.

LPIN

Linnea

Fixed Height Workstations

MFC:	Available in Ash, Autumn Cherry, Beech, Chester Oak, English Walnut, Grey, Grey Nebraska Oak, Laurentii Wenge, Natural Nebraska Oak and White
Nanotech:	Available in Black (3 Week Lead Time)
Veneer:	Available in Oak and Walnut (3 Week Lead Time)
Edging:	Add surcharge for Wenge, Black and Plywood Effect per top - Edging on 25mm White MFC and Black Nanotech only
Metalwork:	Silver, Black Graphite and White - Add surcharge for Chrome Effect and Raw
Additional:	Standard legs (no suffix) - 90 degree legs (suffix .../90 (page 62))



LR16/8

Linnea Rectangular Desk

- Standard lead times. • 25mm top panel.
- Available with 90 degree Linnea leg (see 'Additional' above).

LR20/10	- 2000w x 1000d x 740h
LR18/10	- 1800w x 1000d x 740h
LR16/10	- 1600w x 1000d x 740h
LR15/10	- 1500w x 1000d x 740h
LR14/10	- 1400w x 1000d x 740h
LR12/10	- 1200w x 1000d x 740h

LR20/8	- 2000w x 800d x 740h
LR18/8	- 1800w x 800d x 740h
LR16/8	- 1600w x 800d x 740h
LR15/8	- 1500w x 800d x 740h
LR14/8	- 1400w x 800d x 740h
LR12/8	- 1200w x 800d x 740h
LR10/8	- 1000w x 800d x 740h

LR20/7	- 2000w x 700d x 740h
LR18/7	- 1800w x 700d x 740h
LR16/7	- 1600w x 700d x 740h
LR15/7	- 1500w x 700d x 740h
LR14/7	- 1400w x 700d x 740h
LR12/7	- 1200w x 700d x 740h
LR10/7	- 1000w x 700d x 740h

LR20/6	- 2000w x 600d x 740h
LR18/6	- 1800w x 600d x 740h
LR16/6	- 1600w x 600d x 740h
LR15/6	- 1500w x 600d x 740h
LR14/6	- 1400w x 600d x 740h
LR12/6	- 1200w x 600d x 740h
LR10/6	- 1000w x 600d x 740h



LR16/8/INT

Linnea Rectangular Desk With Shared Inset Intermediate Leg

- Standard lead times. • 25mm top panel.
- Available with 90 degree Linnea leg (see 'Additional' above).

LR20/10/INT	- 2000w x 1000d x 740h
LR18/10/INT	- 1800w x 1000d x 740h
LR16/10/INT	- 1600w x 1000d x 740h
LR15/10/INT	- 1500w x 1000d x 740h
LR14/10/INT	- 1400w x 1000d x 740h
LR12/10/INT	- 1200w x 1000d x 740h

LR20/8/INT	- 2000w x 800d x 740h
LR18/8/INT	- 1800w x 800d x 740h
LR16/8/INT	- 1600w x 800d x 740h
LR15/8/INT	- 1500w x 800d x 740h
LR14/8/INT	- 1400w x 800d x 740h
LR12/8/INT	- 1200w x 800d x 740h
LR10/8/INT	- 1000w x 800d x 740h

LR20/7/INT	- 2000w x 700d x 740h
LR18/7/INT	- 1800w x 700d x 740h
LR16/7/INT	- 1600w x 700d x 740h
LR15/7/INT	- 1500w x 700d x 740h
LR14/7/INT	- 1400w x 700d x 740h
LR12/7/INT	- 1200w x 700d x 740h
LR10/7/INT	- 1000w x 700d x 740h

LR20/6/INT	- 2000w x 600d x 740h
LR18/6/INT	- 1800w x 600d x 740h
LR16/6/INT	- 1600w x 600d x 740h
LR15/6/INT	- 1500w x 600d x 740h
LR14/6/INT	- 1400w x 600d x 740h
LR12/6/INT	- 1200w x 600d x 740h
LR10/6/INT	- 1000w x 600d x 740h

Linnea

Fixed Height Workstations and Returns

MFC:	Available in Ash, Autumn Cherry, Beech, Chester Oak, English Walnut, Grey, Grey Nebraska Oak, Laurentii Wenge, Natural Nebraska Oak and White
Veneer:	Available in Oak and Walnut (3 Week Lead Time)
Edging:	Add surcharge for Wenge, Black and Plywood Effect per top - Edging on 25mm White MFC only
Metalwork:	Silver, Black Graphite and White - Add surcharge for Chrome Effect and Raw
Additional:	Standard legs (no suffix) - 90 degree legs (suffix .../90 (page 62))



L16/10/8RH

Linnea Angular Workstation

- Standard lead times.
- Left-hand and right-hand versions available.
- 25mm top panel.
- 600mm return.
- Available with 90 degree Linnea leg (see 'Additional' above).

- L20/10/8... (LH or RH)** - 2000w x 1000-800d x 740h
L18/10/8... (LH or RH) - 1800w x 1000-800d x 740h
L16/10/8... (LH or RH) - 1600w x 1000-800d x 740h
L14/10/8... (LH or RH) - 1400w x 1000-800d x 740h

- L20/8/6... (LH or RH)** - 2000w x 800-600d x 740h
L18/8/6... (LH or RH) - 1800w x 800-600d x 740h
L16/8/6... (LH or RH) - 1600w x 800-600d x 740h
L14/8/6... (LH or RH) - 1400w x 800-600d x 740h



LC120/12/8

Linnea 120 Degree Cluster Workstation

- Standard lead times.
- 25mm top panel.
- Configured as a 3 person module.
- Available with 90 degree Linnea leg (see 'Additional' above).

- LC120/12/8** - 2884w (dia) x 740h (1200w back edge x 800d return)
LC120/12/6 - 2683w (dia) x 740h (1200w back edge x 600d return)
LC120/10/6 - 2332w (dia) x 740h (1000w back edge x 600d return)



LC120/12/8/INT

Linnea 120 Degree Cluster Workstation with Shared Inset Intermediate Leg

- Standard lead times.
- 25mm top panel.
- Configured as a 3 person module.
- Comes with 1x full leg and 1x inset leg.
- Available with 90 degree Linnea leg (see 'Additional' above).

- LC120/12/8/INT** - 2884w (dia) x 740h (1200w back edge x 800d return)
LC120/12/6/INT - 2683w (dia) x 740h (1200w back edge x 600d return)
LC120/10/6/INT - 2332w (dia) x 740h (1000w back edge x 600d return)



LRR18

Linnea Radius Reception Desk

- Standard lead times.
- 25mm top panel.
- Available with 90 degree Linnea leg (see 'Additional' above).

- LRR20** - 2000w (extreme) x 800d x 740h
LRR18 - 1800w (extreme) x 800d x 740h



LSR12/8RH

Linnea Secretarial Return

- Standard lead times.
- Left-hand and right-hand versions available.
- 25mm top panel.
- Available with 90 degree Linnea leg (see 'Additional' above).

- LSR12/8... (LH or RH)...** - 1200w x 800d x 740h
LSR10/8... (LH or RH)... - 1000w x 800d x 740h
LSR12/6... (LH or RH)... - 1200w x 600d x 740h
LSR10/6... (LH or RH)... - 1000w x 600d x 740h

Compatibility: For use with rectangular desking (no suffix)
For use with angular workstations (suffix .../X (600d secretarial returns only))

Linnea

Extensions and Accessories

MFC:	Available in Ash, Autumn Cherry, Beech, Chester Oak, English Walnut, Grey, Grey Nebraska Oak, Laurentii Wenge, Natural Nebraska Oak and White
Veneer:	Available in Oak and Walnut (3 Week Lead Time)
Edging:	Add surcharge for Wenge, Black and Plywood Effect per top - Edging on 25mm White MFC only
Metalwork:	Silver, Black Graphite and White - Add surcharge for Chrome Effect and Raw
Additional:	Standard legs (no suffix) - 90 degree legs (suffix .../90 (page 62))



LCME16/6

Linnea Curved Extension

- Standard lead times.
- 25mm top panel.

- LCME16/6...** - For 1600mm Ends - 1600w x 650d x 740h
- LCME14/5...** - For 1400mm Ends - 1400w x 500d x 740h
- LCME12/5...** - For 1200mm Ends - 1200w x 500d x 740h

Compatibility: Desking with no screens and all 120 degree clusters (no suffix)
Desking with system or contract screens (suffix .../S and add 27mm to width)
Desking with acoustic screens (suffix .../A and add 38mm to width)



LSME16/6

Linnea Straight Extension

- Standard lead times.
- 25mm top panel.

- LSME16/6...** - For 1600mm Ends - 1600w x 650d x 740h
- LSME14/5...** - For 1400mm Ends - 1400w x 500d x 740h
- LSME12/5...** - For 1200mm Ends - 1200w x 500d x 740h

Compatibility: Desking with no screens and all 120 degree clusters (no suffix)
Desking with system or contract screens (suffix .../S and add 27mm to width)
Desking with acoustic screens (suffix .../A and add 38mm to width)



LDDSE16

Linnea Decorative Slab End and Leg Frame

- Standard lead times.
- Comes with 1x leg frame with decorative slab end.
- Designed to cover the ends of Linnea runs of desks.
- Can be retrofitted.
- For use on one end of the workstation (for use on both ends, specify 2x slab ends).
- Available for use with 90 degree Linnea leg (see 'Additional' above).

- LDDSE16** - For 1600d Ends
- LDDSE14** - For 1400d Ends
- LDDSE12** - For 1200d Ends



LSDSE08

- LSDSE10** - For 1000d Ends
- LSDSE08** - For 800d Ends
- LSDSE07** - For 700d Ends
- LSDSE06** - For 600d Ends

Linnea

Accessories

Metalwork: Silver, Black Graphite and White - Add surcharge for Chrome Effect and Raw

Additional: Standard legs (no suffix) - 90 degree legs (suffix **.../90** (below))



LCP16/INT
Illustrated in red

Linnea Inset Vertical Leg Wire Management Plates

- Standard lead times.
- Designed to conceal cables passing vertically into the horizontal cable trays.
- Can be retrofitted.
- Available for use with 90 degree Linnea leg (see 'Additional' above).

LCP16/INT - For 1600d Ends

LCP14/INT - For 1400d Ends

LCP12/INT - For 1200d Ends



L16/16/90
Illustrated in red



LR16/8/90
Illustrated in red

Linnea Optional 90 Degree Linnea Leg

- Standard lead times.
- Replaced standard angled Linnea legs with 90 degree versions.
- Suffix **.../90** to the end of relevant Linnea codes.
- No upcharge.

.../90 - 90 Degree Linnea Leg



Black Nanotech - Contact Customer Services for specification, prices and lead time

Linnea

Accessories

Metalwork: Silver, Black Graphite and White - Add surcharge for Chrome Effect and Raw



LHSS/16D
Illustrated in red

Linnea Height Settable Spacers for Double Benches

- Standard lead times.
- Supplied with 12x 25mm, 12x 50mm and 12x 75mm top spacers and 6 single arms.
- Single arms replace the double shared arms.
- Adjusts both worktops and enables them to slide.

- LHSS/16D** - For 1600d Ends
LHSS/14D - For 1400d Ends
LHSS/12D - For 1200d Ends



LHSS/S
Illustrated in red

Linnea Height Settable Spacers for Single Workstations

- Standard lead times.
- Supplied with 6x 25mm, 6x 50mm and 6x 75mm top spacers.

- LHSS/S** - For 1000d, 800d, 700d and 600d Ends



LRMP16
Illustrated in red

Linnea Steel Modesty Panel

- Standard lead times.
- Modesty panels are 275mm high.

- LRMP20** - For 2000w Workstations - 1760w
LRMP18 - For 1800w Workstations - 1560w
LRMP16 - For 1600w Workstations - 1360w
LRMP15 - For 1500w Workstations - 1260w
LRMP14 - For 1400w Workstations - 1160w
LRMP12 - For 1200w Workstations - 960w
LRMP10 - For 1000w Workstations - 760w

- LRRMP20** - For LRR20 - 1380w
LRRMP18 - For LRR18 - 1260w



LRCT16
Illustrated in red

Linnea Cable Tray

- Standard lead times.
- Cable trays can be accessed from the front or back of the desk via the easy slot and hook design.
- 222d cable trays will only accept 2 gang sockets such as SK2/U (page 303).

- LRCT20** - For 2000w and 1000d and 800d Workstations - 1470w x 222d
LRCT18 - For 1800w and 1000d and 800d Workstations - 1270w x 222d
LRCT16 - For 1600w and 1000d and 800d Workstations - 1070w x 222d
LRCT15 - For 1500w and 1000d and 800d Workstations and LRR20 - 970w x 222d
LRCT14 - For 1400w and 1000d and 800d Workstations and LRR18 - 870w x 222d
LRCT12 - For 1200w and 1000d and 800d Workstations - 670w x 222d
LRCT10 - For 1000w and 1000d and 800d Workstations - 470w x 222d



LRCT16/7/6
Illustrated in red

- LRCT20/7/6** - For 2000w and 700d and 600d Workstations - 1630w x 116d
LRCT18/7/6 - For 1800w and 700d and 600d Workstations - 1430w x 116d
LRCT16/7/6 - For 1600w and 700d and 600d Workstations - 1230w x 116d
LRCT15/7/6 - For 1500w and 700d and 600d Workstations - 1130w x 116d
LRCT14/7/6 - For 1400w and 700d and 600d Workstations - 1030w x 116d
LRCT12/7/6 - For 1200w and 700d and 600d Workstations - 830w x 116d
LRCT10/7/6 - For 1000w and 700d and 600d Workstations - 630w x 116d

- L120D12** - For 1200w 120 Degree Clusters - 850w x 222d
L120D10 - For 1000w 120 Degree Clusters - 630w x 222d

Linnea

Accessories, Featured Compatible Items and Compatibility Breakdown

Metalwork:

Silver, Black Graphite and White - Add surcharge for Chrome Effect and Raw
 Add surcharge for Praline, Olive Green, Atlantic Blue, Sapphire Blue, Mustard Yellow, Terracotta and Conker Brown (2 Week Lead Time)



LLCR
 Illustrated in red

Linnea Cable Risers

- Standard lead times.
- Single channel cable riser (2 per pack).

LLCR

Linnea Featured Compatible Items



Linnea CPU Holder

- Includes Linnea mounting kit.

LCPU (Black)
 LCPU/W (White)

See page 310 for details.



Maya Monitor Arm

- Clamp On and Bolt Through Desk Fixings.

MMA1/W (White)
 MMA1/B (Black)

See page 306 for details.



Maya Dual Monitor Arm

- Clamp On and Bolt Through Desk Fixings.

MMA2/W (White)
 MMA2/B (Black)

See page 306 for details.



Maya Laptop Stand

- Attaches onto Maya Monitor Arms.

MMA/LS/B (Black)

See page 306 for details.



Slinky Cable Riser

- Suitable for all desk ranges.

SCR/S (Silver)
 SCR/B (Black)
 SCR/W (White)

See page 310 for details.

Linnea Compatibility Breakdown

- **Black** - Compatible
- **Orange** - Non-standard position required
- **Blue** - Conflict when using screens without .../V
- **Purple** - Conflict when using cable tray
- **Green** - Unspecified
- **Red** - May not support larger modules

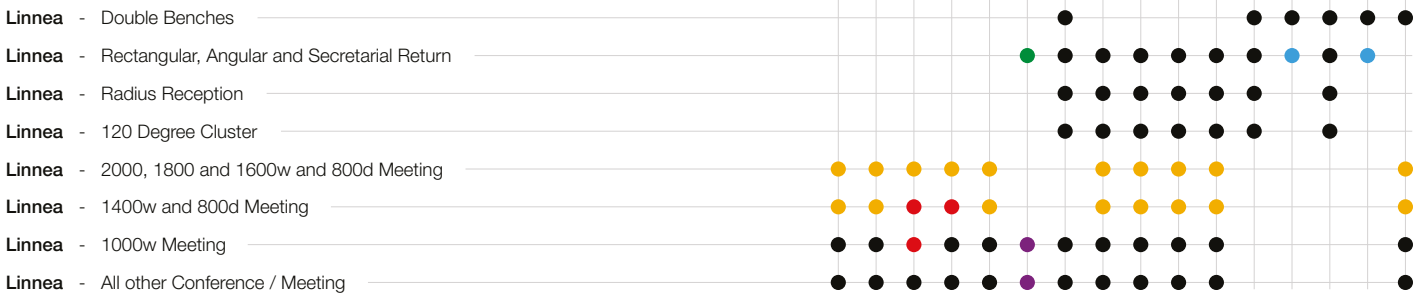

Linnea

Fixed Height Conference and Meeting Tables

- MFC:** Available in Ash, Autumn Cherry, Beech, Chester Oak, English Walnut, Grey, Grey Nebraska Oak, Laurentii Wenge, Natural Nebraska Oak and White
Veneer: Available in Oak and Walnut (3 Week Lead Time)
Edging: Add surcharge for Wenge, Black and Plywood Effect per top - Edging on 25mm White MFC only
Metalwork: Silver, Black Graphite and White - Add surcharge for Chrome Effect and Raw
 Add surcharge for Praline, Olive Green, Atlantic Blue, Sapphire Blue, Mustard Yellow, Terracotta and Conker Brown (2 Week Lead Time)
- Additional:** Standard legs (no suffix) - 90 degree legs (suffix .../90 (page 62))



LCONF48

Linnea Double 'D' Ended Conference Table

- Standard lead times. • 25mm top panel.
- Available with 90 degree Linnea leg (see 'Additional' above).

LCONF48 - 4800w x 1200d x 740h
 2x 1700mm and 1x 1400mm Sections - Seating up to 16 People



LCONF44

Linnea Double 'D' Ended Conference Table

- Standard lead times. • 25mm top panel.
- Available with 90 degree Linnea leg (see 'Additional' above).

LCONF44 - 4400w x 1200d x 740h
 2x 2200mm Sections - Seating up to 14 People

LCONF34 - 3400w x 1200d x 740h
 2x 1700mm Sections - Seating up to 10 People



LCONF24

Linnea Double 'D' Ended Conference Table

- Standard lead times. • 25mm top panel.
- Available with 90 degree Linnea leg (see 'Additional' above).

LCONF24 - 2400w x 1200d x 740h
 1x 2400mm Section - Seating up to 8 People

LCONF20 - 2000w x 1200d x 740h
 1x 2000mm Section - Seating up to 6 People



LMT16/12

Linnea Meeting Table

- Standard lead times. • 25mm top panel.
- Available with 90 degree Linnea leg (see 'Additional' above).

LMT22/16 - 2200w x 1600d x 740h
LMT20/16 - 2000w x 1600d x 740h
LMT18/16 - 1800w x 1600d x 740h
LMT16/16 - 1600w x 1600d x 740h
LMT14/16 - 1400w x 1600d x 740h
LMT12/16 - 1200w x 1600d x 740h

LMT22/14 - 2200w x 1400d x 740h
LMT20/14 - 2000w x 1400d x 740h
LMT18/14 - 1800w x 1400d x 740h
LMT16/14 - 1600w x 1400d x 740h
LMT14/14 - 1400w x 1400d x 740h
LMT12/14 - 1200w x 1400d x 740h

LMT22/12 - 2200w x 1200d x 740h
LMT20/12 - 2000w x 1200d x 740h
LMT18/12 - 1800w x 1200d x 740h
LMT16/12 - 1600w x 1200d x 740h
LMT14/12 - 1400w x 1200d x 740h
LMT12/12 - 1200w x 1200d x 740h

LMT20/10 - 2000w x 1000d x 740h
LMT18/10 - 1800w x 1000d x 740h
LMT16/10 - 1600w x 1000d x 740h
LMT14/10 - 1400w x 1000d x 740h
LMT12/10 - 1200w x 1000d x 740h
LMT10/10 - 1000w x 1000d x 740h

LMT20/8 - 2000w x 800d x 740h
LMT18/8 - 1800w x 800d x 740h
LMT16/8 - 1600w x 800d x 740h
LMT14/8 - 1400w x 800d x 740h
LMT12/8 - 1200w x 800d x 740h
LMT10/8 - 1000w x 800d x 740h

Linnea

Meeting Tables and Accessories

- MFC:** Available in Ash, Autumn Cherry, Beech, Chester Oak, English Walnut, Grey, Grey Nebraska Oak, Laurentii Wenge, Natural Nebraska Oak and White
Veneer: Available in Oak and Walnut (3 Week Lead Time)
Edging: Add surcharge for Wenge, Black and Plywood Effect per top - Edging on 25mm White MFC only
Metalwork: Silver, Black Graphite and White - Add surcharge for Chrome Effect and Raw
 Add surcharge for Praline, Olive Green, Atlantic Blue, Sapphire Blue, Mustard Yellow, Terracotta and Conker Brown (2 Week Lead Time)
- Additional:** Standard legs (no suffix) - 90 degree legs (suffix .../90 (page 62))



LMT16/12/INT

Linnea Meeting Table with Shared Inset Intermediate Leg

- Standard lead times. • 25mm top panel.
- Available with 90 degree Linnea leg (see 'Additional' above).

- LMT22/16/INT** - 2200w x 1600d x 740h
LMT20/16/INT - 2000w x 1600d x 740h
LMT18/16/INT - 1800w x 1600d x 740h
LMT16/16/INT - 1600w x 1600d x 740h
LMT14/16/INT - 1400w x 1600d x 740h
LMT12/16/INT - 1200w x 1600d x 740h

- LMT22/14/INT** - 2200w x 1400d x 740h
LMT20/14/INT - 2000w x 1400d x 740h
LMT18/14/INT - 1800w x 1400d x 740h
LMT16/14/INT - 1600w x 1400d x 740h
LMT14/14/INT - 1400w x 1400d x 740h
LMT12/14/INT - 1200w x 1400d x 740h

- LMT22/12/INT** - 2200w x 1200d x 740h
LMT20/12/INT - 2000w x 1200d x 740h
LMT18/12/INT - 1800w x 1200d x 740h
LMT16/12/INT - 1600w x 1200d x 740h
LMT14/12/INT - 1400w x 1200d x 740h
LMT12/12/INT - 1200w x 1200d x 740h

- LMT20/10/INT** - 2000w x 1000d x 740h
LMT18/10/INT - 1800w x 1000d x 740h
LMT16/10/INT - 1600w x 1000d x 740h
LMT14/10/INT - 1400w x 1000d x 740h
LMT12/10/INT - 1200w x 1000d x 740h
LMT10/10/INT - 1000w x 1000d x 740h

Linnea Conference / Meeting Cable Tray

- Standard lead times. • Tray can be positioned to the users side of the workstation or towards the middle.



LINCTC24
Illustrated in red

- LINCTC48** - For LCONF48 - 1030w x 116d (3x)
LINCTC44 - For LCONF44 - 1630w x 116d (2x)
LINCTC34 - For LCONF34 - 1030w x 116d (2x)
LINCTC24 - For LCONF24 - 1430w x 116d
LINCTC20 - For LCONF20 - 1030w x 116d



LDCT16/14/16D
Illustrated in red

- LDCT22/14/16D** - For 2200w and 1600d and 1400d Meeting Tables - 700w x 416d (2x)
LDCT20/14/16D - For 2000w and 1600d and 1400d Meeting Tables - 1800w x 416d
LDCT18/14/16D - For 1800w and 1600d and 1400d Meeting Tables - 1600w x 416d
LDCT16/14/16D - For 1600w and 1600d and 1400d Meeting Tables - 1400w x 416d
LDCT14/14/16D - For 1400w and 1600d and 1400d Meeting Tables - 1200w x 416d
LDCT12/14/16D - For 1200w and 1600d and 1400d Meeting Tables - 1000w x 416d



LDCT16/12D
Illustrated in red

- LDCT22/12D** - For 2200w and 1200d Meeting Tables - 700w x 308d (2x)
LDCT20/12D - For 2000w and 1200d Meeting Tables - 1800w x 308d
LDCT18/12D - For 1800w and 1200d Meeting Tables - 1600w x 308d
LDCT16/12D - For 1600w and 1200d Meeting Tables - 1400w x 308d
LDCT14/12D - For 1400w and 1200d Meeting Tables - 1200w x 308d
LDCT12/12D - For 1200w and 1200d Meeting Tables - 1000w x 308d



LMCT16
Illustrated in red

- LMCT20** - For 2000w and 1000d Meeting Tables - 1630w x 116d
LMCT18 - For 1800w and 1000d Meeting Tables - 1430w x 116d
LMCT16 - For 1600w and 1000d Meeting Tables - 1230w x 116d
LMCT14 - For 1400w and 1000d Meeting Tables - 1030w x 116d
LMCT12 - For 1200w and 1000d Meeting Tables - 830w x 116d
LMCT10 - For 1000w and 1000d Meeting Tables - 630w x 116d



LRCT16
Illustrated in red

- LRCT20** - For 2000w and 800d Meeting Tables - 1470w x 222d
LRCT18 - For 1800w and 800d Meeting Tables - 1270w x 222d
LRCT16 - For 1600w and 800d Meeting Tables - 1070w x 222d
LRCT14 - For 1400w and 800d Meeting Tables - 870w x 222d
LRCT12 - For 1200w and 800d Meeting Tables - 670w x 222d
LRCT10 - For 1000w and 800d Meeting Tables - 470w x 222d

Linnea

Desk Mounted System Screens

Fabric:	Fully upholstered with pinnable surface - See below for pricing groups
Acrylic:	Available in Blue, Green, Orange, Red, Frosted and Clear
MFC:	Available in Ash, Autumn Cherry, Beech, Chester Oak, English Walnut, Grey, Grey Nebraska Oak, Laurentii Wenge, Natural Nebraska Oak and White
Metalwork:	Anodised Silver, Black Graphite and White
Fabric Groups:	Group 1 - Add surcharge for Group 2-7



ELSS16F

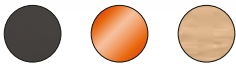

Fabric, Acrylic and MFC Finishes

Linnea Desk Mounted System Screen for Double Benches

- Standard lead time.
- Straight dividing screens with aluminium trim and optional management rail.
- All screens suitable for screen mounted accessories.
- Screen is bracketed to the double bench leg frames.
- Available as Hygiene Protection Screens and add-ons (see HPS Guide).
- Optional screen mounted accessories available (page 293).

Straight System Screen

ELSS20...	- 1973w x 27d x 375h
ELSS18...	- 1773w x 27d x 375h
ELSS16...	- 1573w x 27d x 375h
ELSS15...	- 1473w x 27d x 375h
ELSS14...	- 1373w x 27d x 375h
ELSS12...	- 1173w x 27d x 375h
ELSS10...	- 973w x 27d x 375h

Straight System Screen with Management Rail

ELSS20M...	- 1973w x 27d x 375h
ELSS18M...	- 1773w x 27d x 375h
ELSS16M...	- 1573w x 27d x 375h
ELSS15M...	- 1473w x 27d x 375h
ELSS14M...	- 1373w x 27d x 375h
ELSS12M...	- 1173w x 27d x 375h
ELSS10M...	- 973w x 27d x 375h

Finishes:	Fabric System Screens with or without Management Rail (suffix ...F) Acrylic System Screens with or without Management Rail (suffix ...A) MFC System Screens without Management Rail (suffix ...MFC) MFC System Screens with Management Rail (suffix .../MFC)
------------------	---

Additional: Optional 4 way link post (ELLP410)



ESS16F

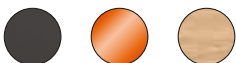

Fabric, Acrylic and MFC Finishes

Linnea Desk Mounted System Screen for Single Workstations

- Standard lead time.
- Straight dividing screens with aluminium trim and optional management rail.
- All screens suitable for screen mounted accessories.
- Screen is bracketed to the outer edge of the desk top.
- Available as Hygiene Protection Screens and add-ons (see HPS Guide).
- Optional screen mounted accessories available (page 293).

Straight System Screen

ESS20...	- 1973w x 27d x 375h
ESS18...	- 1773w x 27d x 375h
ESS16...	- 1573w x 27d x 375h
ESS15...	- 1473w x 27d x 375h
ESS14...	- 1373w x 27d x 375h
ESS12...	- 1173w x 27d x 375h
ESS10...	- 973w x 27d x 375h

Straight System Screen with Management Rail

ESS20M...	- 1973w x 27d x 375h
ESS18M...	- 1773w x 27d x 375h
ESS16M...	- 1573w x 27d x 375h
ESS15M...	- 1473w x 27d x 375h
ESS14M...	- 1373w x 27d x 375h
ESS12M...	- 1173w x 27d x 375h
ESS10M...	- 973w x 27d x 375h

Finishes:	Fabric System Screens with or without Management Rail (suffix ...F) Acrylic System Screens with or without Management Rail (suffix ...A) MFC System Screens without Management Rail (suffix ...MFC) MFC System Screens with Management Rail (suffix .../MFC)
------------------	---

Compatibility: For use **without** Power Modules and Monitor Arms with brackets (no suffix)
For use **with** Power Modules and Monitor Arms with brackets (creates a minimum 12mm void) (suffix .../V)

Additional: Optional 4 way link post (ELP375)

Linnea

Desk Mounted System Screens

Fabric:	Fully upholstered with pinnable surface - <i>See below for pricing groups</i>
Acrylic:	Available in Blue, Green, Orange, Red, Frosted and Clear
MFC:	Available in Ash, Autumn Chery, Beech, Chester Oak, English Walnut, Grey, Grey Nebraska Oak, Laurentii Wenge, Natural Nebraska Oak and White
Metalwork:	Anodised Silver, Black Graphite and White
Fabric Groups:	Group 1 - Add surcharge for Group 2-7



ELSS120/12F

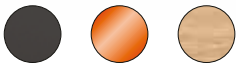

Fabric, Acrylic and MFC Finishes

Linnea Desk Mounted System Screen for 120 Degree Workstations

- Standard lead time. • 3 way link post is required (**ELP375/120**).
- Straight dividing screens with aluminium trim and optional management rail.
- All screens suitable for screen mounted accessories.
- Screen is fixed to the link post at one end and is bracketed to the leg frame at the other end.
- Available as Hygiene Protection Screens and add-ons (see **HPS Guide**).
- Optional screen mounted accessories available (page 293).

Straight System Screen

- ELSS120/12M...** - 1179w x 27d x 375h
ELSS120/10M... - 979w x 27d x 375h

Straight System Screen with Management Rail

- ELSS120/12M...** - 1179w x 27d x 375h
ELSS120/10M... - 979w x 27d x 375h

Finishes: Fabric System Screens with or without Management Rail (suffix **...F**)
 Acrylic System Screens with or without Management Rail (suffix **...A**)
 MFC System Screens without Management Rail (suffix **...MFC**)
 MFC System Screens with Management Rail (suffix **.../MFC**)

Additional: 3 way link post is required (**ELP375/120**)



ESSMR16F

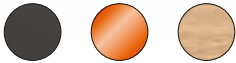

Fabric, Acrylic and MFC Finishes

Linnea Desk Mounted Mid Return System Screen for Double Benches and Single Workstations

- Standard lead time. • 4 way link post is required (**ELLP410** (for benches) and **ELLP375** (for single workstations)).
- Straight dividing screens with aluminium trim and optional management rail.
- All screens suitable for screen mounted accessories.
- Screen is fixed to the link post at one end and uses a metal blade between the desk tops to fix its position.
- Available as Hygiene Protection Screens and add-ons (see **HPS Guide**).
- Optional screen mounted accessories available (page 293).

Straight System Screen

- ESSMR22M...** - 2173w x 27d x 375h
ESSMR20M... - 1973w x 27d x 375h
ESSMR19M... - 1873w x 27d x 375h
ESSMR18M... - 1773w x 27d x 375h
ESSMR17M... - 1673w x 27d x 375h
ESSMR16M... - 1573w x 27d x 375h
ESSMR10M... - 973w x 27d x 375h
ESSMR8M... - 773w x 27d x 375h
ESSMR7M... - 673w x 27d x 375h
ESSMR6M... - 573w x 27d x 375h

Straight System Screen with Management Rail

- ESSMR22M...** - 2173w x 27d x 375h
ESSMR20M... - 1973w x 27d x 375h
ESSMR19M... - 1873w x 27d x 375h
ESSMR18M... - 1773w x 27d x 375h
ESSMR17M... - 1673w x 27d x 375h
ESSMR16M... - 1573w x 27d x 375h
ESSMR10M... - 973w x 27d x 375h
ESSMR8M... - 773w x 27d x 375h
ESSMR7M... - 673w x 27d x 375h
ESSMR6M... - 573w x 27d x 375h

Finishes: Fabric System Screens with or without Management Rail (suffix **...F**)
 Acrylic System Screens with or without Management Rail (suffix **...A**)
 MFC System Screens without Management Rail (suffix **...MFC**)
 MFC System Screens with Management Rail (suffix **.../MFC**)

Additional: 4 way link post is required (**ELLP410** (for benches) and **ELP375** (for single workstations))

Linnea

Desk Mounted System Screens

Fabric:	Fully upholstered with pinnable surface - See below for pricing groups
Acrylic:	Available in Blue, Green, Orange, Red, Frosted and Clear
MFC:	Available in Ash, Autumn Cherry, Beech, Chester Oak, English Walnut, Grey, Grey Nebraska Oak, Laurentii Wenge, Natural Nebraska Oak and White
Metalwork:	Anodised Silver, Black Graphite and White
Fabric Groups:	Group 1 - Add surcharge for Group 2-7



ESSER8F

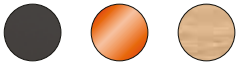

Fabric, Acrylic and MFC Finishes

Linnea Desk Mounted End Return System Screen for Single Workstations

- Standard lead time. • 4 way link post is required (ELP375).
- Straight dividing screens with aluminium trim and optional management rail.
- All screens suitable for screen mounted accessories.
- Screen is fixed to the link post at one end and is bracketed to the desk tops at the other.
- Available as Hygiene Protection Screens and add-ons (see HPS Guide).
- Optional screen mounted accessories available (page 293).

Straight System Screen

ESSER22...	- 2173w x 27d x 375h
ESSER20...	- 1973w x 27d x 375h
ESSER19...	- 1873w x 27d x 375h
ESSER18...	- 1773w x 27d x 375h
ESSER17...	- 1673w x 27d x 375h
ESSER16...	- 1573w x 27d x 375h
ESSER10...	- 973w x 27d x 375h
ESSER8...	- 773w x 27d x 375h
ESSER7...	- 673w x 27d x 375h
ESSER6...	- 573w x 27d x 375h

Straight System Screen with Management Rail

ESSER22M...	- 2173w x 27d x 375h
ESSER20M...	- 1973w x 27d x 375h
ESSER19M...	- 1873w x 27d x 375h
ESSER18M...	- 1773w x 27d x 375h
ESSER17M...	- 1673w x 27d x 375h
ESSER16M...	- 1573w x 27d x 375h
ESSER10M...	- 973w x 27d x 375h
ESSER8M...	- 773w x 27d x 375h
ESSER7M...	- 673w x 27d x 375h
ESSER6M...	- 573w x 27d x 375h

Finishes: Fabric System Screens with or without Management Rail (suffix ...F)
Acrylic System Screens with or without Management Rail (suffix ...A)
MFC System Screens without Management Rail (suffix ...MFC)
MFC System Screens with Management Rail (suffix .../MFC)

Additional: 4 way link post is required (ELP375)



ESSPR14F

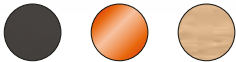

Fabric, Acrylic and MFC Finishes

Linnea Desk Mounted Ped Return System Screen for Single Workstations

- Standard lead time. • 4 way link post is required (ELP375).
- Straight dividing screens with aluminium trim and optional management rail.
- All screens suitable for screen mounted accessories.
- Screen is fixed to the link post at one end and is bracketed to the desk tops at the other before the pedestal.
- Available as Hygiene Protection Screens and add-ons (see HPS Guide).
- Optional screen mounted accessories available (page 293).

Straight System Screen

ESSPR14...	- 1392w x 27d x 375h
ESSPR12...	- 1192w x 27d x 375h

Straight System Screen with Management Rail

ESSPR14M...	- 1392w x 27d x 375h
ESSPR12M...	- 1192w x 27d x 375h

Finishes: Fabric System Screens with or without Management Rail (suffix ...F)
Acrylic System Screens with or without Management Rail (suffix ...A)
MFC System Screens without Management Rail (suffix ...MFC)
MFC System Screens with Management Rail (suffix .../MFC)

Additional: 4 way link post is required (ELP375)

Linnea

Desk Mounted Acoustic and Flexible Return Screens

Fabric: Fully upholstered with pinnable surface - See below for pricing groups
Acrylic: Available in Blue, Green, Orange, Red, Frosted and Clear
Metalwork: Anodised Silver, Black Graphite and White

Fabric Groups: Group 1 - Add surcharge for Group 2-7



AELSS16F



Fabric Finish

Linnea Desk Mounted Acoustic Screen for Double Benches

- Standard lead time. • Straight dividing screens faced with 6mm polyester fibre insulation board.
- Screen is bracketed to the double bench leg frames. • Link post not required.
- Class B certified in accordance with International Standards: ISO 354:2003, ISO 11654:1997 and ISO 9613-1:1993
- Available as Hygiene Protection Screens and add-ons (see HPS Guide).

Straight Acoustic Screen

- AELSS20F** - 1973w x 38d x 375h
- AELSS18F** - 1773w x 38d x 375h
- AELSS16F** - 1573w x 38d x 375h
- AELSS15F** - 1473w x 38d x 375h
- AELSS14F** - 1373w x 38d x 375h
- AELSS12F** - 1173w x 38d x 375h
- AELSS10F** - 973w x 38d x 375h



AESS16F



Fabric Finish

Linnea Desk Mounted Acoustic Screen for Single Workstations

- Standard lead time. • Straight dividing screens faced with 6mm polyester fibre insulation board.
- Screen is bracketed to the outer edge of the desk top. • Link post not required.
- Class B certified in accordance with International Standards: ISO 354:2003, ISO 11654:1997 and ISO 9613-1:1993
- Available as Hygiene Protection Screens and add-ons (see HPS Guide).

Straight Acoustic Screen

- AESS20F** - 1973w x 38d x 375h
- AESS18F** - 1773w x 38d x 375h
- AESS16F** - 1573w x 38d x 375h
- AESS15F** - 1473w x 38d x 375h
- AESS14F** - 1373w x 38d x 375h
- AESS12F** - 1173w x 38d x 375h
- AESS10F** - 973w x 38d x 375h

Compatibility: For use without Power Modules and Monitor Arms with brackets (no suffix)
 For use with Power Modules and Monitor Arms with brackets (creates a minimum 12mm void) (suffix .../V)



ALSSRC8A



Curved Acrylic Screen



Acrylic Finish

Linnea Desk Mounted Flexible Return Screen for Double Benches and Single Workstations

- Standard lead time. • Desk mounted curved dividing screens.
- Screen hooks over existing screens at any position and is stabilised by a flat foot.

Curved Acrylic Screen

- ELSSRC8A** - 780w x 5d x 375-200h
- ELSSRC7A** - 680w x 5d x 375-200h
- ELSSRC6A** - 580w x 5d x 375-200h



Fabric: Fully upholstered with pinnable (pinnable Contract) and non-pinnable (Flexible Return and non-pinnable Contract) surface - See below for pricing groups

Fabric Groups: Group 1 - Add surcharge for Group 2-7



ECSFR8

Linnea Desk Mounted Flexible Return Contract Screen for Double Benches

- 2 week lead time.
- Straight dividing screen with rounded corners.
- Screen slides onto the front of the desktop at desired position and can be moved at any time.
- Screens overhang the front of the desktop by 143mm.

Straight Contract Screen

- ECSFR10** - 1100w x 36d x 375h
- ECSFR8** - 900w x 36d x 375h
- ECSFR7** - 800w x 36d x 375h
- ECSFR6** - 700w x 36d x 375h



Straight Acoustic Screen



Fabric Finish



ELPCS16FP

Linnea Desk Mounted Contract Screen for Double Benches

- Standard lead time.
- Straight dividing screens with pinnable or non-pinnable fully upholstered surface.
- Pullover style fabric application.
- Screen is bracketed to the double bench leg frames.
- Link post not required.
- Available as Hygiene Protection Screens and add-ons (see HPS Guide).

Straight Pinnable Contract Screen

- ELPCS20FP** - 1973w x 38d x 375h
- ELPCS18FP** - 1773w x 38d x 375h
- ELPCS16FP** - 1573w x 38d x 375h
- ELPCS15FP** - 1473w x 38d x 375h
- ELPCS14FP** - 1373w x 38d x 375h
- ELPCS12FP** - 1173w x 38d x 375h
- ELPCS10FP** - 973w x 38d x 375h



Fabric Finish

Straight Contract Screen

- ELPCS20F** - 1973w x 27d x 375h
- ELPCS18F** - 1773w x 27d x 375h
- ELPCS16F** - 1573w x 27d x 375h
- ELPCS15F** - 1473w x 27d x 375h
- ELPCS14F** - 1373w x 27d x 375h
- ELPCS12F** - 1173w x 27d x 375h
- ELPCS10F** - 973w x 27d x 375h



EPCS16FP

Linnea Desk Mounted Contract Screen for Single Workstations

- Standard lead time.
- Straight dividing screens with pinnable or non-pinnable fully upholstered surface.
- Pullover style fabric application.
- Screen is bracketed to the outer edge of the desk top.
- Link post not required.
- Available as Hygiene Protection Screens and add-ons (see HPS Guide).

Straight Pinnable Contract Screen

- EPCS20FP** - 1973w x 38d x 375h
- EPCS18FP** - 1773w x 38d x 375h
- EPCS16FP** - 1573w x 38d x 375h
- EPCS15FP** - 1473w x 38d x 375h
- EPCS14FP** - 1373w x 38d x 375h
- EPCS12FP** - 1173w x 38d x 375h
- EPCS10FP** - 973w x 38d x 375h



Fabric Finish

Straight Contract Screen

- EPCS20F** - 1973w x 27d x 375h
- EPCS18F** - 1773w x 27d x 375h
- EPCS16F** - 1573w x 27d x 375h
- EPCS15F** - 1473w x 27d x 375h
- EPCS14F** - 1373w x 27d x 375h
- EPCS12F** - 1173w x 27d x 375h
- EPCS10F** - 973w x 27d x 375h

Compatibility: For use without Power Modules and Monitor Arms with brackets (no suffix)
For use with Power Modules and Monitor Arms with brackets (creates a minimum 12mm void) (suffix .../M)

Matrix+

Fixed Height Workstations and Screens



New for 2024, Matrix+ has been designed with enhanced and innovative features at an affordable price. Enhancements include the introduction of a scalloped rear edge and sliding tops to double benches, facilitating the use of desktop screens, monitor arms and cable access. An upgraded warranty of 15 years and industry leading manufacturing lead time of only 7-10 days. The range offers configurations of single workstations and double benches, for use as single units or connected with shared inset leg frames for creating a consecutive run of desks, 120-degree cluster workstations, desk extensions, meeting and conference tables. This delivers a comprehensive range that fulfils the requirement of current collaborative workspaces.



Matrix+

Fixed Height Workstations

MFC: Available in Ash, Autumn Cherry, Beech, Chester Oak, English Walnut, Grey, Grey Nebraska Oak, Laurentii Wenge, Natural Nebraska Oak and White
Nanotech: Available in Black (2 Week Lead Time)
Edging: Add surcharge for Wenge, Black and Plywood Effect per top - Edging on 25mm White MFC and Black Nanotech only
Metalwork: Silver, Black Graphite and White - Underframe in Black Graphite



MP16/16

Matrix+ Double Bench

- Standard lead times.
- 2x 25mm sliding top panels.
- Horizontal cable tray not supplied.
- Underframe in Black Graphite.

MP20/16 - 2000w x 1600d x 740h
MP18/16 - 1800w x 1600d x 740h
MP16/16 - 1600w x 1600d x 740h
MP14/16 - 1400w x 1600d x 740h
MP12/16 - 1200w x 1600d x 740h
MP10/16 - 1000w x 1600d x 740h

MP20/14 - 2000w x 1400d x 740h
MP18/14 - 1800w x 1400d x 740h
MP16/14 - 1600w x 1400d x 740h
MP14/14 - 1400w x 1400d x 740h
MP12/14 - 1200w x 1400d x 740h
MP10/14 - 1000w x 1400d x 740h

MP20/12 - 2000w x 1200d x 740h
MP18/12 - 1800w x 1200d x 740h
MP16/12 - 1600w x 1200d x 740h
MP14/12 - 1400w x 1200d x 740h
MP12/12 - 1200w x 1200d x 740h
MP10/12 - 1000w x 1200d x 740h



MP16/16/INT

Matrix+ Double Bench with Shared Inset Intermediate Leg

- Standard lead times.
- 2x 25mm sliding top panels.
- Horizontal cable tray not supplied.
- Underframe in Black Graphite.

MP20/16/INT - 2000w x 1600d x 740h
MP18/16/INT - 1800w x 1600d x 740h
MP16/16/INT - 1600w x 1600d x 740h
MP14/16/INT - 1400w x 1600d x 740h
MP12/16/INT - 1200w x 1600d x 740h
MP10/16/INT - 1000w x 1600d x 740h

MP20/14/INT - 2000w x 1400d x 740h
MP18/14/INT - 1800w x 1400d x 740h
MP16/14/INT - 1600w x 1400d x 740h
MP14/14/INT - 1400w x 1400d x 740h
MP12/14/INT - 1200w x 1400d x 740h
MP10/14/INT - 1000w x 1400d x 740h

MP20/12/INT - 2000w x 1200d x 740h
MP18/12/INT - 1800w x 1200d x 740h
MP16/12/INT - 1600w x 1200d x 740h
MP14/12/INT - 1400w x 1200d x 740h
MP12/12/INT - 1200w x 1200d x 740h
MP10/12/INT - 1000w x 1200d x 740h



PPLM
Illustrated in red

Matrix+ Locking Mechanism

- Standard lead time.
- Sold in pairs.
- Retrofittable locking mechanism.
- Located under bench top.

PPLM - Sold in Pairs

Matrix+

Fixed Height Workstations

MFC:	Available in Ash, Autumn Cherry, Beech, Chester Oak, English Walnut, Grey, Grey Nebraska Oak, Laurentii Wenge, Natural Nebraska Oak and White
Nanotech:	Available in Black (2 Week Lead Time)
Edging:	Add surcharge for Wenge, Black and Plywood Effect per top - Edging on 25mm White MFC and Black Nanotech only
Metalwork:	Silver, Black Graphite and White - Underframe in Black Graphite



MPR16/8

Matrix+ Rectangular Desk

- Standard lead times. • 25mm top panel. • Horizontal cable tray not supplied. • Underframe in Black Graphite.
- 640h mobile pedestals will protrude with all rectangular desk if a cable tray is specified, as an alternative, use MPF and MP3 pedestals (page 215).

MPR20/8	- 2000w x 800d x 740h
MPR18/8	- 1800w x 800d x 740h
MPR16/8	- 1600w x 800d x 740h
MPR14/8	- 1400w x 800d x 740h
MPR12/8	- 1200w x 800d x 740h
MPR10/8	- 1000w x 800d x 740h

MPR20/7	- 2000w x 700d x 740h
MPR18/7	- 1800w x 700d x 740h
MPR16/7	- 1600w x 700d x 740h
MPR14/7	- 1400w x 700d x 740h
MPR12/7	- 1200w x 700d x 740h
MPR10/7	- 1000w x 700d x 740h

MPR20/6	- 2000w x 600d x 740h
MPR18/6	- 1800w x 600d x 740h
MPR16/6	- 1600w x 600d x 740h
MPR14/6	- 1400w x 600d x 740h
MPR12/6	- 1200w x 600d x 740h
MPR10/6	- 1000w x 600d x 740h



MPR16/8/INT

Matrix+ Rectangular Desk with Shared Inset Intermediate Leg

- Standard lead times. • 25mm top panel. • Horizontal cable tray not supplied. • Underframe in Black Graphite.
- 640h mobile pedestals will protrude with all rectangular desk if a cable tray is specified, as an alternative, use MPF and MP3 pedestals (page 215).

MPR20/8/INT	- 2000w x 800d x 740h
MPR18/8/INT	- 1800w x 800d x 740h
MPR16/8/INT	- 1600w x 800d x 740h
MPR14/8/INT	- 1400w x 800d x 740h
MPR12/8/INT	- 1200w x 800d x 740h
MPR10/8/INT	- 1000w x 800d x 740h

MPR20/7/INT	- 2000w x 700d x 740h
MPR18/7/INT	- 1800w x 700d x 740h
MPR16/7/INT	- 1600w x 700d x 740h
MPR14/7/INT	- 1400w x 700d x 740h
MPR12/7/INT	- 1200w x 700d x 740h
MPR10/7/INT	- 1000w x 700d x 740h

MPR20/6/INT	- 2000w x 600d x 740h
MPR18/6/INT	- 1800w x 600d x 740h
MPR16/6/INT	- 1600w x 600d x 740h
MPR14/6/INT	- 1400w x 600d x 740h
MPR12/6/INT	- 1200w x 600d x 740h
MPR10/6/INT	- 1000w x 600d x 740h



MP16/10/8RH

Matrix+ Angular Workstation

- Standard lead times. • 25mm top panel. • Horizontal cable tray not supplied.
- Underframe in Black Graphite.

MP20/10/8... (LH or RH)	- 2000w x 1000-800d x 740h
MP18/10/8... (LH or RH)	- 1800w x 1000-800d x 740h
MP16/10/8... (LH or RH)	- 1600w x 1000-800d x 740h
MP14/10/8... (LH or RH)	- 1400w x 1000-800d x 740h

MP20/8/6... (LH or RH)	- 2000w x 800-600d x 740h
MP18/8/6... (LH or RH)	- 1800w x 800-600d x 740h
MP16/8/6... (LH or RH)	- 1600w x 800-600d x 740h
MP14/8/6... (LH or RH)	- 1400w x 800-600d x 740h

Matrix+

Fixed Height Workstations and Extensions

MFC:	Available in Ash, Autumn Cherry, Beech, Chester Oak, English Walnut, Grey, Grey Nebraska Oak, Laurentii Wenge, Natural Nebraska Oak and White
Nanotech:	Available in Black (2 Week Lead Time)
Edging:	Add surcharge for Wenge, Black and Plywood Effect per top - Edging on 25mm White MFC and Black Nanotech only
Metalwork:	Silver, Black Graphite and White - Underframe in Black Graphite



MPMA18/16RH

Matrix+ Managers Workstation

- Standard lead times.
- 2x 25mm top panels.
- Horizontal cable tray not supplied.
- Underframe in Black Graphite.
- 640h mobile pedestals will protrude with all managers workstations if a cable tray is specified, as an alternative, use MPF and MP3 pedestals (page 215).

MPMA18/18... (LH or RH) - 1800w x 1800d x 740h

MPMA16/18... (LH or RH) - 1600w x 1800d x 740h

MPMA18/16... (LH or RH) - 1800w x 1600d x 740h

MPMA16/16... (LH or RH) - 1600w x 1600d x 740h



MP120/12/8

Matrix+ 120 Degree Workstation

- Standard lead times.
- 25mm top panel.
- Horizontal cable tray not supplied.
- Underframe in Black Graphite.
- Can be configured as a single workstation or in modules of 3, 6, 9, etc.

MP120/12/8 - 2078w (extreme) x 740h (1200w back edge x 800d return)

MP120/12/6 - 2078w (extreme) x 740h (1200w back edge x 600d return)

MP120/10/6 - 1732w (extreme) x 740h (1000w back edge x 600d return)



MP120/12/8/INT

Matrix+ 120 Degree Workstation with Shared Inset Intermediate Leg

- Standard lead times.
- 25mm top panel.
- Horizontal cable tray not supplied.
- Underframe in Black Graphite.
- Can be a single workstation or configured as a 3, 6, 9, etc, person module.
- Must be configured alongside M120... Workstations.

MP120/12/8/INT - 2078w (extreme) x 740h (1200w back edge x 800d return)

MP120/12/6/INT - 2078w (extreme) x 740h (1200w back edge x 600d return)

MP120/10/6/INT - 1732w (extreme) x 740h (1000w back edge x 600d return)



Matrix+

Accessories

MFC: Available in Ash, Autumn Cherry, Beech, Chester Oak, English Walnut, Grey, Grey Nebraska Oak, Laurentii Wenge, Natural Nebraska Oak and White
Nanotech: Available in Black (2 Week Lead Time)
Edging: Add surcharge for Wenge, Black and Plywood Effect per top - Edging on 25mm White MFC and Black Nanotech only
Metalwork: **MPSR..., MPDSE... and MPSDSE...:** Silver, Black Graphite and White - Underframe in Black Graphite
MPSME...: Black Graphite



MPSR10/6RH

Matrix+ Secretarial Return

- Standard lead times. • 25mm top panel. • Horizontal cable tray not supplied.
- Underframe in Black Graphite.

MPSR10/6... (LH or RH)... - 1000w x 600d x 740h

Compatibility: For use with rectangular desking (no suffix)
 For use with angular workstations (suffix .../X (600d secretarial returns only))



MPSME16/6

Matrix+ Straight Extension and Leg Frame

- Standard lead times. • 25mm top panel. • Underframe in Black Graphite.

MPSME16/6... - For 1600d Ends - 1600w x 600d x 740h
MPSME14/5... - For 1400d Ends - 1400w x 500d x 740h
MPSME12/5... - For 1200d Ends - 1200w x 500d x 740h

Compatibility: Desking with no screens and all 120 degree clusters (no suffix)
 Desking with system or contract screens (suffix .../S and add 34mm to width)
 Desking with acoustic screens (suffix .../A and add 45mm to width)



MPDSE16



MPSDSE08

Matrix+ Decorative Slab End and Leg Frame

- Standard lead times. • Designed to cover the ends of Matrix runs of desks. • Can be retrofitted.
- For use on one end of the workstation (for use on both ends, specify 2x slab ends).

MPDSE16 - For 1600d Ends
MPDSE14 - For 1400d Ends
MPDSE12 - For 1200d Ends

MPSDSE10 - For 1000d Ends
MPSDSE08 - For 800d Ends
MPSDSE07 - For 700d Ends
MPSDSE06 - For 600d Ends



Matrix+

Accessories

MFC: Available in Ash, Autumn Cherry, Beech, Chester Oak, English Walnut, Grey, Grey Nebraska Oak, Laurentii Wenge, Natural Nebraska Oak and White
Nanotech: Available in Black (2 Week Lead Time)
Metalwork: **MPRMP..., MPARMP... and MPCR:** Silver, Black Graphite and White
MPA...: Black Graphite



MPRMP16

Matrix+ MFC Modesty Panel

- Standard lead times.
- Modesty panels are 18mm deep and 300mm high.

MPRMP20	- For 2000w Workstations	- 1620w
MPRMP18	- For 1800w Workstations	- 1420w
MPRMP16	- For 1600w Workstations	- 1220w
MPRMP14	- For 1400w Workstations	- 1020w
MPRMP12	- For 1200w Workstations	- 820w
MPRMP10	- For 1000w Workstations	- 620w



MPARMP16
Illustrated in red

Matrix+ Steel Modesty Panel

- Standard lead times.
- Modesty panels are 290mm high.

MPARMP20	- For 2000w Workstations	- 1620w
MPARMP18	- For 1800w Workstations	- 1420w
MPARMP16	- For 1600w Workstations	- 1220w
MPARMP14	- For 1400w Workstations	- 1020w
MPARMP12	- For 1200w Workstations	- 820w
MPARMP10	- For 1000w Workstations	- 620w



MPA7D
Illustrated in red

Matrix+ Cable Tray for Double Benches

- Standard lead times.
- High capacity cable management system neatly conceals power, data and telecom cables through a hinged cable management tray.
- Cable trays are 222mm deep and 92mm high.

MPA10D	- For 2000w Double Benches	- 1700w
MPA9D	- For 1800w Double Benches	- 1500w
MPA7D	- For 1600w Double Benches	- 1300w
MPA5D	- For 1400w Double Benches	- 1100w
MPA3D	- For 1200w Double Benches	- 900w
MPA2D	- For 1000w Double Benches	- 700w



MPA7
Illustrated in red

Matrix+ Cable Tray for Single Workstations

- Standard lead times.
- Tray can be positioned to the users side of the workstation or towards the rear.
- Cable trays are 100mm deep and 110mm high.

MPA10	- For 2000w Workstations	- 1600w
MPA9	- For 1800w Workstations	- 1400w
MPA7	- For 1600w Workstations and 1800w Managers Workstation	- 1200w
MPA5	- For 1400w Workstations and 1600w Managers Workstation	- 1000w
MPA3	- For 1200w Workstations and 1200w 120 Degree Clusters	- 800w
MPA2	- For 1000w Workstations and 1000w 120 Degree Clusters	- 600w

MPA12	- For Managers Workstations with 1800d Return	- 1300w
MPA11	- For Managers Workstations with 1600d Return	- 1100w



MPCR
Illustrated in red

Matrix+ Cable Risers

- Standard lead times.
- Single channel cable riser (2 per pack).

MPCR	- For Fixed Height Workstations
-------------	---------------------------------

Matrix+

Featured Compatible Items, Compatibility Breakdown and Conference Tables

MFC: Available in Ash, Autumn Cherry, Beech, Chester Oak, English Walnut, Grey, Grey Nebraska Oak, Laurentii Wenge, Natural Nebraska Oak and White
Nanotech: Available in Black (2 Week Lead Time)
Edging: Add surcharge for Wenge, Black and Plywood Effect per top - Edging on 25mm White MFC and Black Nanotech only
Metalwork: Silver, Black Graphite and White - Underframe in Black Graphite

Matrix+ Featured Compatible Items



Matrix+ CPU Holder

- Includes Matrix+ mounting kit.

MPCPU (Black)
MPCPU/W (White)

See page 310 for details.



Maya Monitor Arm

- Clamp On and Bolt Through Desk Fixings.

MMA1/W (White)
MMA1/B (Black)

See page 306 for details.



Maya Dual Monitor Arm

- Clamp On and Bolt Through Desk Fixings.

MMA2/W (White)
MMA2/B (Black)

See page 306 for details.



Maya Laptop Stand

- Attaches onto Maya Monitor Arms.

MMA/LS/B (Black)

See page 306 for details.



Slinky Cable Riser

- Suitable for all desk ranges.

SCR/S (Silver)
SCR/B (Black)
SCR/W (White)

See page 310 for details.

Matrix+ Compatibility Breakdown

- **Black** - Compatible
- **Orange** - Non-standard position required
- **Blue** - Conflict when using screens without .../V
- **Green** - Unspecified

- Matrix+** - Double Benches
- Matrix+** - Rectangular and Angular
- Matrix+** - 120 Degree
- Matrix+** - Secretarial Return
- Matrix+** - Conference / Meeting

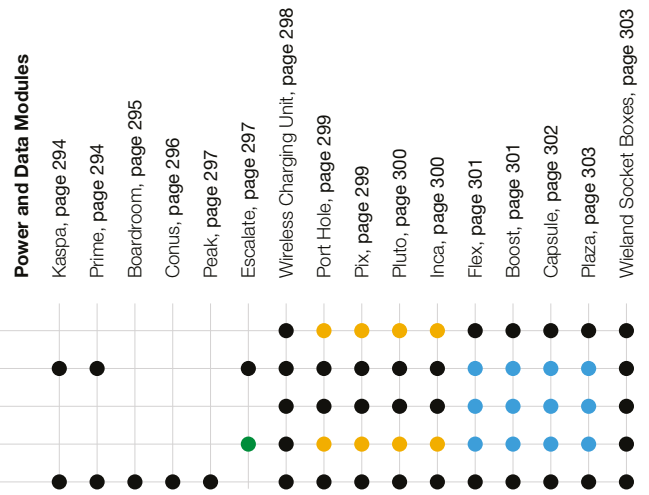

MPCONF34

Matrix+ Fixed Height Rectangular Conference Table

- Standard lead times. • 25mm top panel. • Underframe in Black Graphite.

MPCONF34 - 3400w x 1200d x 740h
 2x 1700mm Sections - Seating up to 10 People

Matrix+

Fixed Height Meeting Tables

MFC: Available in Ash, Autumn Cherry, Beech, Chester Oak, English Walnut, Grey, Grey Nebraska Oak, Laurentii Wenge, Natural Nebraska Oak and White
Nanotech: Available in Black (2 Week Lead Time)
Edging: Add surcharge for Wenge, Black and Plywood Effect per top - Edging on 25mm White MFC and Black Nanotech only
Metalwork: Silver, Black Graphite and White - Underframe in Black Graphite



MPMT16/12

Matrix+ Meeting Table

- Standard lead times. • 25mm top panel. • Underframe in Black Graphite.

MPMT20/16 - 2000w x 1600d x 740h
MPMT18/16 - 1800w x 1600d x 740h
MPMT16/16 - 1600w x 1600d x 740h
MPMT14/16 - 1400w x 1600d x 740h
MPMT12/16 - 1200w x 1600d x 740h

MPMT20/14 - 2000w x 1400d x 740h
MPMT18/14 - 1800w x 1400d x 740h
MPMT16/14 - 1600w x 1400d x 740h
MPMT14/14 - 1400w x 1400d x 740h
MPMT12/14 - 1200w x 1400d x 740h

MPMT20/12 - 2000w x 1200d x 740h
MPMT18/12 - 1800w x 1200d x 740h
MPMT16/12 - 1600w x 1200d x 740h
MPMT14/12 - 1400w x 1200d x 740h
MPMT12/12 - 1200w x 1200d x 740h

MPMT20/10 - 2000w x 1000d x 740h
MPMT18/10 - 1800w x 1000d x 740h
MPMT16/10 - 1600w x 1000d x 740h
MPMT14/10 - 1400w x 1000d x 740h
MPMT12/10 - 1200w x 1000d x 740h
MPMT10/10 - 1000w x 1000d x 740h

MPMT20/8 - 2000w x 800d x 740h
MPMT18/8 - 1800w x 800d x 740h
MPMT16/8 - 1600w x 800d x 740h
MPMT14/8 - 1400w x 800d x 740h
MPMT12/8 - 1200w x 800d x 740h
MPMT10/8 - 1000w x 800d x 740h



MPMT16/12/INT

Matrix+ Meeting Table with Shared Inset Intermediate Leg

- Standard lead times. • 25mm top panel. • Underframe in Black Graphite.

MPMT20/16/INT - 2000w x 1600d x 740h
MPMT18/16/INT - 1800w x 1600d x 740h
MPMT16/16/INT - 1600w x 1600d x 740h
MPMT14/16/INT - 1400w x 1600d x 740h
MPMT12/16/INT - 1200w x 1600d x 740h

MPMT20/14/INT - 2000w x 1400d x 740h
MPMT18/14/INT - 1800w x 1400d x 740h
MPMT16/14/INT - 1600w x 1400d x 740h
MPMT14/14/INT - 1400w x 1400d x 740h
MPMT12/14/INT - 1200w x 1400d x 740h

MPMT20/12/INT - 2000w x 1200d x 740h
MPMT18/12/INT - 1800w x 1200d x 740h
MPMT16/12/INT - 1600w x 1200d x 740h
MPMT14/12/INT - 1400w x 1200d x 740h
MPMT12/12/INT - 1200w x 1200d x 740h

MPMT20/10/INT - 2000w x 1000d x 740h
MPMT18/10/INT - 1800w x 1000d x 740h
MPMT16/10/INT - 1600w x 1000d x 740h
MPMT14/10/INT - 1400w x 1000d x 740h
MPMT12/10/INT - 1200w x 1000d x 740h
MPMT10/10/INT - 1000w x 1000d x 740h

MPMT20/8/INT - 2000w x 800d x 740h
MPMT18/8/INT - 1800w x 800d x 740h
MPMT16/8/INT - 1600w x 800d x 740h
MPMT14/8/INT - 1400w x 800d x 740h
MPMT12/8/INT - 1200w x 800d x 740h
MPMT10/8/INT - 1000w x 800d x 740h

Matrix+

Accessories

Metalwork: Black Graphite



MPA7D
Illustrated in red



MPA7
Illustrated in red

Matrix+ Conference / Meeting Cable Tray

- Standard lead times. • Tray can be positioned to the users side of the workstation or towards the middle.

MPA8D - For MPCONF34 - 1400w x 222d (2x)

MPA10D - For 2000w and 1600d, 1400d and 1200d Meeting Tables - 1700w x 222d

MPA9D - For 1800w and 1600d, 1400d and 1200d Meeting Tables - 1500w x 222d

MPA7D - For 1600w and 1600d, 1400d and 1200d Meeting Tables - 1300w x 222d

MPA5D - For 1400w and 1400d and 1200d Meeting Tables - 1100w x 222d

MPA3D - For 1200w and 1200d Meeting Tables - 900w x 222d

MPA10 - For 2000w and 1000d and 800d Meeting Tables - 1600w x 100d

MPA9 - For 1800w and 1000d and 800d Meeting Tables - 1400w x 100d

MPA7 - For 1600w and 1000d and 800d Meeting Tables - 1200w x 100d

MPA5 - For 1400w and 1000d and 800d Meeting Tables - 1000w x 100d

MPA3 - For 1200w and 1000d and 800d Meeting Tables - 800w x 100d

MPA2 - For 1000w and 1000d and 800d Meeting Tables - 600w x 100d



Matrix+

Desk Mounted System Screens

Fabric: Fully upholstered with pinnable surface - See below for pricing groups
Acrylic: Available in Blue, Green, Orange, Red, Frosted and Clear
MFC: Available in Ash, Autumn Cherry, Beech, Chester Oak, English Walnut, Grey, Grey Nebraska Oak, Laurentii Wenge, Natural Nebraska Oak and White
Metalwork: **For Double Benches:** Black Graphite only
For Single Workstations: Anodised Silver, Black Graphite and White

Fabric Groups: Group 1 - Add surcharge for Group 2-7



ELSS16F

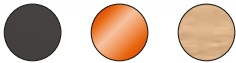

Fabric, Acrylic and MFC Finishes

Matrix+ Desk Mounted System Screen for Double Benches

- Standard lead time.
- Straight dividing screens with aluminium trim and optional management rail.
- Screen is bracketed to the double bench leg frames.
- Screen brackets available in Black Graphite only.
- Available as Hygiene Protection Screens and add-ons (see HPS Guide).
- Optional screen mounted accessories available (see page 293).

Straight System Screen

ELSS20... - 1973w x 27d x 375h
ELSS18... - 1773w x 27d x 375h
ELSS16... - 1573w x 27d x 375h
ELSS14... - 1373w x 27d x 375h
ELSS12... - 1173w x 27d x 375h
ELSS10... - 973w x 27d x 375h

Straight System Screen with Management Rail

ELSS20M... - 1973w x 27d x 375h
ELSS18M... - 1773w x 27d x 375h
ELSS16M... - 1573w x 27d x 375h
ELSS14M... - 1373w x 27d x 375h
ELSS12M... - 1173w x 27d x 375h
ELSS10M... - 973w x 27d x 375h

Finishes: Fabric System Screens with or without Management Rail (suffix ...F)
 Acrylic System Screens with or without Management Rail (suffix ...A)
 MFC System Screens without Management Rail (suffix ...MFC)
 MFC System Screens with Management Rail (suffix .../MFC)

Additional: Optional 4 way link post (ELLP410)



ESS16F

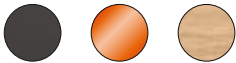

Fabric, Acrylic and MFC Finishes

Matrix+ Desk Mounted System Screen for Single Workstations

- Standard lead time.
- Straight dividing screens with aluminium trim and optional management rail.
- Screen is bracketed to the outer edge of the desk top.
- Available as Hygiene Protection Screens and add-ons (see HPS Guide).
- Optional screen mounted accessories available (see page 293).

Straight System Screen

ESS20... - 1973w x 27d x 375h
ESS18... - 1773w x 27d x 375h
ESS16... - 1573w x 27d x 375h
ESS14... - 1373w x 27d x 375h
ESS12... - 1173w x 27d x 375h
ESS10... - 973w x 27d x 375h

Straight System Screen with Management Rail

ESS20M... - 1973w x 27d x 375h
ESS18M... - 1773w x 27d x 375h
ESS16M... - 1573w x 27d x 375h
ESS14M... - 1373w x 27d x 375h
ESS12M... - 1173w x 27d x 375h
ESS10M... - 973w x 27d x 375h

Finishes: Fabric System Screens with or without Management Rail (suffix ...F)
 Acrylic System Screens with or without Management Rail (suffix ...A)
 MFC System Screens without Management Rail (suffix ...MFC)
 MFC System Screens with Management Rail (suffix .../MFC)

Compatibility: For use **without** Power Modules and Monitor Arms with brackets (no suffix)
 For use **with** Power Modules and Monitor Arms with brackets (creates a minimum 12mm void) (suffix .../V)

Matrix+

Desk Mounted System Screens

Fabric:	Fully upholstered with pinnable surface - See below for pricing groups
Acrylic:	Available in Blue, Green, Orange, Red, Frosted and Clear
MFC:	Available in Ash, Autumn Cherry, Beech, Chester Oak, English Walnut, Grey, Grey Nebraska Oak, Laurentii Wenge, Natural Nebraska Oak and White
Metalwork:	Anodised Silver, Black Graphite and White
Fabric Groups:	Group 1 - Add surcharge for Group 2-7



ELSS120/12F

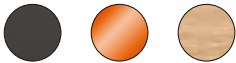

Fabric, Acrylic and MFC Finishes

Matrix+ Desk Mounted System Screen for 120 Degree Workstations

- Standard lead time. • 3 way link post is required (ELP375/120).
- Straight dividing screens with aluminium trim and optional management rail.
- Screen is fixed to the link post at one end and is bracketed to the leg frame at the other end.
- Available as Hygiene Protection Screens and add-ons (see HPS Guide).
- Optional screen mounted accessories available (see page 293).

Straight System Screen

ESS120/12... - 1179w x 27d x 375h
ESS120/10... - 979w x 27d x 375h

Straight System Screen with Management Rail

ESS120/12M... - 1179w x 27d x 375h
ESS120/10M... - 979w x 27d x 375h

Finishes: Fabric System Screens with or without Management Rail (suffix ...F)
 Acrylic System Screens with or without Management Rail (suffix ...A)
 MFC System Screens without Management Rail (suffix ...MFC)
 MFC System Screens with Management Rail (suffix .../MFC)

Additional: 3 way link post is required (ELP375/120)



ESSMR16F



ESSMR16F

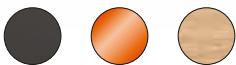

Fabric, Acrylic and MFC Finishes

Matrix+ Desk Mounted Mid Return System Screen for Double Benches and Single Workstations

- Standard lead time. • 4 way link post is required (ELLP410 (for benches) and ELLP375 (for single workstations)).
- Straight dividing screens with aluminium trim and optional management rail.
- Screen is fixed to the link post at one end and uses a metal blade between the desk tops to fix its position.
- Available as Hygiene Protection Screens and add-ons (see HPS Guide).
- Optional screen mounted accessories available (see page 293).

Straight System Screen

ESSMR20... - 1973w x 27d x 375h
ESSMR18... - 1773w x 27d x 375h
ESSMR17... - 1673w x 27d x 375h
ESSMR16... - 1573w x 27d x 375h
ESSMR10... - 973w x 27d x 375h
ESSMR8... - 773w x 27d x 375h
ESSMR7... - 673w x 27d x 375h
ESSMR6... - 573w x 27d x 375h

Straight System Screen with Management Rail

ESSMR20M... - 1973w x 27d x 375h
ESSMR18M... - 1773w x 27d x 375h
ESSMR17M... - 1673w x 27d x 375h
ESSMR16M... - 1573w x 27d x 375h
ESSMR10M... - 973w x 27d x 375h
ESSMR8M... - 773w x 27d x 375h
ESSMR7M... - 673w x 27d x 375h
ESSMR6M... - 573w x 27d x 375h

Finishes: Fabric System Screens with or without Management Rail (suffix ...F)
 Acrylic System Screens with or without Management Rail (suffix ...A)
 MFC System Screens without Management Rail (suffix ...MFC)
 MFC System Screens with Management Rail (suffix .../MFC)

Additional: 4 way link post is required (ELLP410 (for benches) and ELP375 (for single workstations))

Matrix+

Desk Mounted Acoustic and Flexible Return Screens

Fabric: Fully upholstered with pinnable (Acoustic) or non-pinnable (Contract) surface - See below for pricing groups

Fabric Groups: Group 1 - Add surcharge for Group 2-7



AELSS16F



Fabric Finish

Matrix+ Desk Mounted Acoustic Screen for Double Benches

- Standard lead time.
- Straight dividing screens faced with 6mm polyester fibre insulation board.
- Screen is bracketed to the double bench leg frames.
- Link post not required.
- Class B certified in accordance with International Standards: ISO 354:2003, ISO 11654:1997 and ISO 9613-1:1993
- Available as Hygiene Protection Screens and add-ons (see HPS Guide).

Straight Acoustic Screen

- AELSS20F** - 1973w x 38d x 375h
- AELSS18F** - 1773w x 38d x 375h
- AELSS16F** - 1573w x 38d x 375h
- AELSS14F** - 1373w x 38d x 375h
- AELSS12F** - 1173w x 38d x 375h
- AELSS10F** - 973w x 38d x 375h



AESS16F



Fabric Finish

Matrix+ Desk Mounted Acoustic Screen for Single Workstations

- Standard lead time.
- Straight dividing screens faced with 6mm polyester fibre insulation board.
- Screen is bracketed to the outer edge of the desk top.
- Link post not required.
- Class B certified in accordance with International Standards: ISO 354:2003, ISO 11654:1997 and ISO 9613-1:1993
- Available as Hygiene Protection Screens and add-ons (see HPS Guide).

Straight Acoustic Screen

- AESS20F** - 1973w x 38d x 375h
- AESS18F** - 1773w x 38d x 375h
- AESS16F** - 1573w x 38d x 375h
- AESS14F** - 1373w x 38d x 375h
- AESS12F** - 1173w x 38d x 375h
- AESS10F** - 973w x 38d x 375h

Compatibility: For use **without** Power Modules and Monitor Arms with brackets (no suffix)
For use **with** Power Modules and Monitor Arms with brackets (creates a minimum 12mm void) (suffix **.../V**)



ECSFR8



Straight Acoustic Screen



Fabric Finish

Matrix+ Desk Mounted Flexible Return Contract Screen for Double Benches

- 2 week lead time.
- Straight dividing screen with rounded corners.
- Screen slides onto the front of the desktop at desired position and can be moved at any time.
- Screens overhang the front of the desktop by 143mm.

Straight Contract Screen

- ECSFR8** - 900w x 36d x 375h
- ECSFR7** - 800w x 36d x 375h
- ECSFR6** - 700w x 36d x 375h

Matrix+

Desk Mounted Contract Screens

Fabric: Fully upholstered non-pinnable surface - See below for pricing groups
Metalwork: Silver, Black Graphite and White

Fabric Groups: Group 1 - Add surcharge for Group 2-7



ECS16F/MP
on an MP16/16



ECS10F/MP
on an MP16/16



Fabric Finish

Matrix+ Desk Mounted Contract Screen for Double Benches

- Standard lead time. • Straight dividing screens with fully upholstered surface.
- Screen is bracketed to the underframe of the double bench.
- Link post not required. • Available as Hygiene Protection Screens and add-ons (see HPS Guide).

Straight Contract Screen

- ECS20F/MP** - For 2000w Double Benches - 1970w x 27d x 375h
- ECS18F/MP** - For 1800w and above Double Benches - 1770w x 27d x 375h
- ECS16F/MP** - For 1600w and above Double Benches - 1570w x 27d x 375h
- ECS14F/MP** - For 1400w and above Double Benches - 1370w x 27d x 375h
- ECS12F/MP** - For 1200w and above Double Benches - 1170w x 27d x 375h
- ECS10F/MP** - For 1000w and above Double Benches - 970w x 27d x 375h



ECS16F/X



Fabric Finish

Matrix+ Desk Mounted Contract Screen for Single Workstations

- Standard lead time. • Straight dividing screens with fully upholstered surface.
- Screen is bracketed to the outer edge of the desk top.
- Link post not required. • Available as Hygiene Protection Screens and add-ons (see HPS Guide).

Straight Contract Screen

- ECS20F...** - 1970w x 27d x 375h
- ECS18F...** - 1770w x 27d x 375h
- ECS16F...** - 1570w x 27d x 375h
- ECS14F...** - 1370w x 27d x 375h
- ECS12F...** - 1170w x 27d x 375h
- ECS10F...** - 970w x 27d x 375h

Compatibility: For use with back to back single desks (no suffix)
 For use with stand alone single desks (suffix .../X)

For use **without** Power Modules and Monitor Arms with brackets (no suffix)
 For use **with** Power Modules and Monitor Arms with brackets (creates a minimum 12mm void) (suffix .../V)

Kassini

Manual Sit / Sit and Fixed Height Workstations



The Kassini range offers a myriad of options that fully utilise the unique wire management solution. Leg risers within the leg upright can be removed to enable cables to be routed vertically within the leg channel and directed into the modesty panel or wire management beam to discreetly house cables and wires. Power and data modules can easily be mounted at any position along the cable beams offering maximum flexibility for complex cable installations. The height adjustable workstations offer adjustment from 650mm to 850mm via a manual rotating handle that can be discreetly retracted within the frame, when not in use. The unique design of Kassini and the minimal number of components required, ensures a swift and efficient assembly process, reducing installation costs. Due to the nature of aluminium, Kassini offers an environmentally friendly solution as the lightweight frame can be recycled at the end of its life cycle.



Kassini

Height Adjustable Workstations

MFC:	Available in Ash, Autumn Cherry, Beech, Chester Oak, English Walnut, Grey, Grey Nebraska Oak, Laurentii Wenge, Natural Nebraska Oak and White
Veneer:	Available in Oak and Walnut (3 Week Lead Time)
Edging:	Add surcharge for Wenge, Black and Plywood Effect per top - Edging on 25mm White MFC only
Metalwork:	Silver, Black Graphite and White - Add surcharge for Chrome Effect



KR16/HA

Kassini Height Adjustable Rectangular Desk

- Standard lead times.
- 25mm top panel.
- Horizontal wire management as standard.
- Sit / sit height adjustment of 650mm-850mm via crank handle.
- Vertical wire management not available.

KR18/HA	- 1800w x 800d x 650-850h
KR16/HA	- 1600w x 800d x 650-850h
KR14/HA	- 1400w x 800d x 650-850h
KR12/HA	- 1200w x 800d x 650-850h
KR10/HA	- 1000w x 800d x 650-850h
KR8/HA	- 800w x 800d x 650-850h

KR18/6/HA	- 1800w x 600d x 650-850h
KR16/6/HA	- 1600w x 600d x 650-850h
KR14/6/HA	- 1400w x 600d x 650-850h
KR12/6/HA	- 1200w x 600d x 650-850h
KR10/6/HA	- 1000w x 600d x 650-850h
KR8/6/HA	- 800w x 600d x 650-850h



KRB16/HA

Kassini Height Adjustable Bow Fronted Rectangular Desk

- Standard lead times.
- 25mm top panel.
- Horizontal wire management as standard.
- Sit / sit height adjustment of 650mm-850mm via crank handle.
- Vertical wire management not available.

KRB18/HA	- 1800w x 900d x 650-850h
KRB16/HA	- 1600w x 900d x 650-850h



KR20DRH/HA

Kassini Height Adjustable 'D' Ended Desk

- Standard lead times.
- 25mm top panel.
- Horizontal wire management as standard.
- Sit / sit height adjustment of 650mm-850mm via crank handle.
- Vertical wire management not available.

KR22D... (LH/HA or RH/HA)	- 2200w x 800d x 650-850h
KR20D... (LH/HA or RH/HA)	- 2000w x 800d x 650-850h



KC16RH/HA

Kassini Height Adjustable Crescent Workstation

- Standard lead times.
- 25mm top panel.
- Horizontal wire management as standard.
- Sit / sit height adjustment of 650mm-850mm via crank handle.
- Vertical wire management not available.
- 600mm return.

KC18... (LH/HA or RH/HA)	- 1800w x 1200d x 650-850h
KC16... (LH/HA or RH/HA)	- 1600w x 1200d x 650-850h
KC14... (LH/HA or RH/HA)	- 1400w x 1200d x 650-850h



KCB18RH/HA

Kassini Height Adjustable Bow Fronted Crescent Workstation

- Standard lead times.
- 25mm top panel.
- Horizontal wire management as standard.
- Sit / sit height adjustment of 650mm-850mm via crank handle.
- Vertical wire management not available.
- 600mm return.

KCB18... (LH/HA or RH/HA)	- 1800w x 1300d x 650-850h
----------------------------------	----------------------------

Kassini

Height Adjustable and Fixed Height Workstations

MFC:	Available in Ash, Autumn Cherry, Beech, Chester Oak, English Walnut, Grey, Grey Nebraska Oak, Laurentii Wenge, Natural Nebraska Oak and White
Veneer:	Available in Oak and Walnut (3 Week Lead Time)
Edging:	Add surcharge for Wenge, Black and Plywood Effect per top - Edging on 25mm White MFC only
Metalwork:	Silver, Black Graphite and White - Add surcharge for Chrome Effect



Kassini Height Adjustable Single Wave Desk

- Standard lead times. • 25mm top panel. • Horizontal wire management as standard.
- Sit / sit height adjustment of 650mm-850mm via crank handle.
- Vertical wire management not available.

KW18... (LH/HA or RH/HA)	- 1800w x 1000-800d x 650-850h
KW16... (LH/HA or RH/HA)	- 1600w x 1000-800d x 650-850h
KW14... (LH/HA or RH/HA)	- 1400w x 1000-800d x 650-850h
KW12... (LH/HA or RH/HA)	- 1200w x 1000-800d x 650-850h

KW18/6... (LH/HA or RH/HA)	- 1800w x 800-600d x 650-850h
KW16/6... (LH/HA or RH/HA)	- 1600w x 800-600d x 650-850h
KW14/6... (LH/HA or RH/HA)	- 1400w x 800-600d x 650-850h
KW12/6... (LH/HA or RH/HA)	- 1200w x 800-600d x 650-850h



Kassini Height Adjustable 120 Degree Workstation

- Standard lead times. • 25mm top panel. • Horizontal wire management as standard.
- Sit / sit height adjustment of 650mm-850mm via crank handle.
- Can be configured as a singular workstation or in modules of 3, 6, 9 etc.
- Vertical wire management not available.

K120/HA	- 2078w (extreme) x 650-850h (1200w back edge x 800d return)
K120/6/HA	- 1732w (extreme) x 650-850h (1000w back edge x 600d return)



Kassini Fixed Height Rectangular Desk

- Standard lead times. • 25mm top panel. • Horizontal wire management as standard.

KR18	- 1800w x 800d x 740h
KR16	- 1600w x 800d x 740h
KR14	- 1400w x 800d x 740h
KR12	- 1200w x 800d x 740h
KR10	- 1000w x 800d x 740h
KR8	- 800w x 800d x 740h

KR18/6	- 1800w x 600d x 740h
KR16/6	- 1600w x 600d x 740h
KR14/6	- 1400w x 600d x 740h
KR12/6	- 1200w x 600d x 740h
KR10/6	- 1000w x 600d x 740h
KR8/6	- 800w x 600d x 740h



Kassini Fixed Height Bow Fronted Rectangular Desk

- Standard lead times. • 25mm top panel. • Horizontal and vertical wire management as standard.

KRB18	- 1800w x 900d x 740h
KRB16	- 1600w x 900d x 740h



Kassini Fixed Height 'D' Ended Desk

- Standard lead times. • 25mm top panel. • Horizontal and vertical wire management as standard.

KR22D... (LH or RH)	- 2200w x 800d x 740h
KR20D... (LH or RH)	- 2000w x 800d x 740h

Kassini

Fixed Height Workstations

MFC:	Available in Ash, Autumn Cherry, Beech, Chester Oak, English Walnut, Grey, Grey Nebraska Oak, Laurentii Wenge, Natural Nebraska Oak and White
Veneer:	Available in Oak and Walnut (<i>3 Week Lead Time</i>)
Edging:	Add surcharge for Wenge, Black and Plywood Effect per top - <i>Edging on 25mm White MFC only</i>
Metalwork:	Silver, Black Graphite and White - Add surcharge for Chrome Effect



KRE19RH

Kassini Fixed Height Radius Executive Desk

- Standard lead times.
- 25mm top panel.
- Horizontal and vertical wire management as standard.

KRE19... (LH or RH) - 1900w x 1000d x 740h



KC16RH

Kassini Fixed Height Crescent Workstation

- Standard lead times.
- 25mm top panel.
- Horizontal and vertical wire management as standard.
- 600mm return.

KC18... (LH or RH) - 1800w x 1200d x 740h

KC16... (LH or RH) - 1600w x 1200d x 740h

KC14... (LH or RH) - 1400w x 1200d x 740h



KCB18RH

Kassini Fixed Height Bow Fronted Crescent Workstation

- Standard lead times.
- 25mm top panel.
- Horizontal and vertical wire management as standard.
- 600mm return.

KCB18... (LH or RH) - 1800w x 1300d x 740h



KRC19RH

Kassini Fixed Height Radius Crescent Workstation

- Standard lead times.
- 25mm top panel.
- Horizontal and vertical wire management as standard.
- 600mm return.

KRC19... (LH or RH) - 1900w x 1200d x 740h

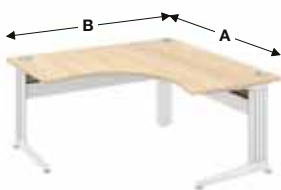

KSC16A

Kassini Fixed Height Symmetrical Crescent Workstation

- Standard lead times.
- 25mm top panel.
- Horizontal and vertical wire management as standard.
- 2x 800mm ends.
- The grain direction is shown as 'A' and 'B'.

KSC18A - 1800w x 1800d x 740h

KSC18B - 1800w x 1800d x 740h

KSC16A - 1600w x 1600d x 740h

KSC16B - 1600w x 1600d x 740h

Kassini

Fixed Height Workstations

MFC: Available in Ash, Autumn Cherry, Beech, Chester Oak, English Walnut, Grey, Grey Nebraska Oak, Laurentii Wenge, Natural Nebraska Oak and White
Veneer: Available in Oak and Walnut (3 Week Lead Time)
Edging: Add surcharge for Wenge, Black and Plywood Effect per top - Edging on 25mm White MFC only
Metalwork: Silver, Black Graphite and White - Add surcharge for Chrome Effect



KW16RH

Kassini Fixed Height Single Wave Desk

- Standard lead times.
- 25mm top panel.
- Horizontal and vertical wire management as standard.

KW18... (LH or RH) - 1800w x 1000-800d x 740h
KW16... (LH or RH) - 1600w x 1000-800d x 740h
KW14... (LH or RH) - 1400w x 1000-800d x 740h
KW12... (LH or RH) - 1200w x 1000-800d x 740h

KW18/6... (LH or RH) - 1800w x 800-600d x 740h
KW16/6... (LH or RH) - 1600w x 800-600d x 740h
KW14/6... (LH or RH) - 1400w x 800-600d x 740h
KW12/6... (LH or RH) - 1200w x 800-600d x 740h



KDW16/9

Kassini Fixed Height Double Wave Desk

- Standard lead times.
- 25mm top panel.
- Horizontal and vertical wire management as standard.

KDW18/9 - 800d Centre - 1800w x 900d x 740h
KDW16/9 - 800d Centre - 1600w x 900d x 740h



K120

Kassini Fixed Height 120 Degree Workstation

- Standard lead times.
- 25mm top panel.
- Can be configured as a singular workstation or in modules of 3, 6, 9 etc.
- Horizontal and vertical wire management as standard.

K120 - 2078w (extreme) x 740h (1200w back edge x 800d return)
K120/6 - 1732w (extreme) x 740h (1000w back edge x 600d return)



KK20

Kassini Fixed Height Kidney Desk

- Standard lead times.
- 25mm top panel.
- Horizontal and vertical wire management as standard.

KK20 - 2000w (extreme) x 800d x 740h

Kassini

Fixed Height Workstations, Linking Workstations, Returns and Extensions

MFC:	Available in Ash, Autumn Cherry, Beech, Chester Oak, English Walnut, Grey, Grey Nebraska Oak, Laurentii Wenge, Natural Nebraska Oak and White
Veneer:	Available in Oak and Walnut (<i>3 Week Lead Time</i>)
Edging:	Add surcharge for Wenge, Black and Plywood Effect per top - <i>Edging on 25mm White MFC only</i>
Metalwork:	Silver, Black Graphite and White - Add surcharge for Chrome Effect



KRR18

Kassini Fixed Height Radius Reception Desk

- Standard lead times. • 25mm top panel. • Horizontal and vertical wire management as standard.

KRR20 - 2000w (extreme) x 800d x 740h

KRR18 - 1800w (extreme) x 800d x 740h



KRDRH

Kassini Fixed Height Reception Desk

- Standard lead times. • 2x 25mm top panels. • 850mm and 600mm ends are slightly curved.
- Horizontal and vertical wire management as standard.

KRD... (LH or RH) - 1850w (extreme) x 1800d x 740h



KLW8/6

Kassini Fixed Height Linking Workstation

- Standard lead times. • 25mm top panel. • Links 800mm and 600mm deep desks.
- Horizontal and vertical wire management as standard.

KLW8/6 - Links 800d Ends - 1225w x 1225d x 740h

KLW8/4 - Links 800d Ends - 1083w x 1083d x 740h

KLW6 - Links 600d Ends - 1025w x 1025d x 740h



KSR10/6RH

Kassini Fixed Height Secretarial Return for Rectangular Desks

- Standard lead times. • 25mm top panel. • Horizontal and vertical wire management as standard.
- Compatible with rectangular, bow fronted rectangular and 'D' ended desks only.

KSR10/6... (LH or RH) - 1000w x 600d x 740h



KSR10/6CRH

Kassini Fixed Height Secretarial Return for Crescent Workstations

- Standard lead times. • 25mm top panel. • Horizontal and vertical wire management as standard.
- Compatible with crescent, bow fronted crescent and radius crescent workstations only.

KSR10/6C... (LH or RH) - 1000w x 600d x 740h



KSCMT16

Kassini Meeting Extension

- Standard lead times. • 25mm top panel.
- Complete with 120mm diameter support leg on 300mm diameter base.

KSCMT16 - For 1600d Ends - 1600w x 660d x 740h

KSCMT12 - For 1200d Ends - 1200w x 600d x 740h

KSCMT8 - For 800d Ends - 800w x 600d x 740h

KSCMT120 - For K120 - 1600w x 660d x 740h

KDWSCMT18 - For Double Wave Desks - 1800w x 800d x 740h

Kassini

Featured Compatible Items and Compatibility Breakdown

Kassini Featured Compatible Items



CPU Holder

- Includes mounting kit.

CPU (Black)

CPU/W (White)

See page 310 for details.



Maya Monitor Arm

- Clamp On and Bolt Through Desk Fixings.

MMA1/W (White)

MMA1/B (Black)

See page 306 for details.



Maya Dual Monitor Arm

- Clamp On and Bolt Through Desk Fixings.

MMA2/W (White)

MMA2/B (Black)

See page 306 for details.



Maya Laptop Stand

- Attaches onto Maya Monitor Arms.

MMA/LS/B (Black)

See page 306 for details.



Slinky Cable Riser

- Suitable for all desk ranges.

SCR/S (Silver)

SCR/B (Black)

SCR/W (White)

See page 310 for details.

Kassini Compatibility Breakdown

● Black - Compatible

● Blue - Conflict when using screens without .../V

	Power and Data Modules															
	Kaspa, page 294	Prime, page 294	Boardroom, page 295	Conus, page 296	Peak, page 297	Escalate, page 297	Wireless Charging Unit, page 298	Port Hole, page 299	Pix, page 299	Pluto, page 300	Inca, page 300	Flex, page 301	Boost, page 301	Capsule, page 302	Plaza, page 303	Wieland Socket Boxes, page 303
Kassini - Rectangular, 'D' Ended and Radius Executive	●	●				●	●	●	●	●	●	●	●	●	●	●
Kassini - Bow Fronted Rectangular and Crescent	●	●				●	●	●	●	●	●	●	●	●	●	●
Kassini - Crescent, Radius Crescent and Symmetrical Crescent	●	●				●	●	●	●	●	●	●	●	●	●	●
Kassini - Single and Double Wave	●	●				●	●	●	●	●	●	●	●	●	●	●
Kassini - 120 Degree	●	●				●	●	●	●	●	●	●	●	●	●	●
Kassini - Kidney, Radius Reception and Reception	●	●				●	●	●	●	●	●	●	●	●	●	●
Kassini - Linking	●	●				●	●	●	●	●	●	●	●	●	●	●
Kassini - Secretarial Return								●	●				●	●		

Optima Plus

Manual Sit / Sit and Fixed Height Workstations and Meeting



The Optima Plus range offers a myriad of footprints to suit the demands of the majority of applications. The unique design of Optima Plus and the minimal number of components required, ensures a swift and efficient assembly process, reducing installation costs. The cantilever leg frame is supported by an integral MFC modesty panel that can be colour matched to the work surface or supplied in a contrast finish. Within the range, a height adjustable workstation offers height adjustment from 650mm to 850mm via a manual rotating handle, that is easily operated by the user and when not in use, discreetly retracts within the frame.



Optima Plus

Height Adjustable Workstations

MFC: Available in Ash, Autumn Cherry, Beech, Chester Oak, English Walnut, Grey, Grey Nebraska Oak, Laurentii Wenge, Natural Nebraska Oak and White
Veneer: Available in Oak and Walnut (3 Week Lead Time)
Edging: Add surcharge for Wenge, Black and Plywood Effect per top - Edging on 25mm White MFC only
Metalwork: Silver, Black Graphite and White - Add surcharge for Chrome Effect



OPR16/HA

Optima Plus Height Adjustable Rectangular Desk

- Standard lead times. • 25mm top panel.
- Sit / sit height adjustment of 650mm-850mm via crank handle.

- OPR18/HA** - 1800w x 800d x 650-850h
- OPR16/HA** - 1600w x 800d x 650-850h
- OPR14/HA** - 1400w x 800d x 650-850h
- OPR12/HA** - 1200w x 800d x 650-850h
- OPR10/HA** - 1000w x 800d x 650-850h
- OPR8/HA** - 800w x 800d x 650-850h

- OPR18/6/HA** - 1800w x 600d x 650-850h
- OPR16/6/HA** - 1600w x 600d x 650-850h
- OPR14/6/HA** - 1400w x 600d x 650-850h
- OPR12/6/HA** - 1200w x 600d x 650-850h
- OPR10/6/HA** - 1000w x 600d x 650-850h
- OPR8/6/HA** - 800w x 600d x 650-850h



OPRB16/HA

Optima Plus Height Adjustable Bow Fronted Rectangular Desk

- Standard lead times. • 25mm top panel.
- Sit / sit height adjustment of 650mm-850mm via crank handle.

- OPRB18/HA** - 1800w x 900d x 650-850h
- OPRB16/HA** - 1600w x 900d x 650-850h

Optima Plus

Height Adjustable Workstations

MFC:	Available in Ash, Autumn Cherry, Beech, Chester Oak, English Walnut, Grey, Grey Nebraska Oak, Laurentii Wenge, Natural Nebraska Oak and White
Veneer:	Available in Oak and Walnut (3 Week Lead Time)
Edging:	Add surcharge for Wenge, Black and Plywood Effect per top - Edging on 25mm White MFC only
Metalwork:	Silver, Black Graphite and White - Add surcharge for Chrome Effect



OPR20DRH/HA

Optima Plus Height Adjustable 'D' Ended Desk

- Standard lead times. • 25mm top panel.
- Sit / sit height adjustment of 650mm-850mm via crank handle.

OPR22D... (LH/HA or RH/HA) - 2200w x 800d x 650-850h

OPR20D... (LH/HA or RH/HA) - 2000w x 800d x 650-850h



OPC16RH/HA

Optima Plus Height Adjustable Crescent Workstation

- Standard lead times. • 25mm top panel.
- Sit / sit height adjustment of 650mm-850mm via crank handle. • 600mm return.

OPC18... (LH/HA or RH/HA) - 1800w x 1200d x 650-850h

OPC16... (LH/HA or RH/HA) - 1600w x 1200d x 650-850h

OPC14... (LH/HA or RH/HA) - 1400w x 1200d x 650-850h



OPCB18RH/HA

Optima Plus Height Adjustable Bow Fronted Crescent Workstation

- Standard lead times. • 25mm top panel.
- Sit / sit height adjustment of 650mm-850mm via crank handle. • 600mm return.

OPCB18... (LH/HA or RH/HA) - 1800w x 1300d x 650-850h



OPW16RH/HA

Optima Plus Height Adjustable Single Wave Desk

- Standard lead times. • 25mm top panel.
- Sit / sit height adjustment of 650mm-850mm via crank handle.

OPW18... (LH or RH) - 1800w x 1000-800d x 650-850h

OPW16... (LH or RH) - 1600w x 1000-800d x 650-850h

OPW14... (LH or RH) - 1400w x 1000-800d x 650-850h

OPW12... (LH or RH) - 1200w x 1000-800d x 650-850h

OPW18/6... (LH or RH) - 1800w x 800-600d x 650-850h

OPW16/6... (LH or RH) - 1600w x 800-600d x 650-850h

OPW14/6... (LH or RH) - 1400w x 800-600d x 650-850h

OPW12/6... (LH or RH) - 1200w x 800-600d x 650-850h



OP120/HA

Optima Plus Height Adjustable 120 Degree Workstation

- Standard lead times. • 25mm top panel.
- Sit / sit height adjustment of 650mm-850mm via crank handle.
- Can be configured as a singular workstation or in modules of 3, 6, 9 etc.

OP120/HA - 2078w (extreme) x 650-850h (1200w back edge x 800d return)

OP120/6/HA - 1732w (extreme) x 650-850h (1000w back edge x 600d return)

Optima Plus

Fixed Height Workstations

MFC:	Available in Ash, Autumn Cherry, Beech, Chester Oak, English Walnut, Grey, Grey Nebraska Oak, Laurentii Wenge, Natural Nebraska Oak and White
Veneer:	Available in Oak and Walnut (3 Week Lead Time)
Edging:	Add surcharge for Wenge, Black and Plywood Effect per top - Edging on 25mm White MFC only
Metalwork:	Silver, Black Graphite and White - Add surcharge for Chrome Effect



OPR16

Optima Plus Fixed Height Rectangular Desk

- Standard lead times.
- 25mm top panel.
- Wire managed legs as standard.

OPR18	- 1800w x 800d x 740h
OPR16	- 1600w x 800d x 740h
OPR14	- 1400w x 800d x 740h
OPR12	- 1200w x 800d x 740h
OPR10	- 1000w x 800d x 740h
OPR8	- 800w x 800d x 740h

OPR18/6	- 1800w x 600d x 740h
OPR16/6	- 1600w x 600d x 740h
OPR14/6	- 1400w x 600d x 740h
OPR12/6	- 1200w x 600d x 740h
OPR10/6	- 1000w x 600d x 740h
OPR8/6	- 800w x 600d x 740h



OPRB16

Optima Plus Fixed Height Bow Fronted Rectangular Desk

- Standard lead times.
- 25mm top panel.
- Wire managed legs as standard.

OPRB18	- 1800w x 900d x 740h
OPRB16	- 1600w x 900d x 740h



OPR20DRH

Optima Plus Fixed Height 'D' Ended Desk

- Standard lead times.
- 25mm top panel.
- Wire managed legs as standard.

OPR22D... (LH or RH)	- 2200w x 800d x 740h
OPR20D... (LH or RH)	- 2000w x 800d x 740h



OPRE19RH

Optima Plus Fixed Height Radius Executive Desk

- Standard lead times.
- 25mm top panel.
- Wire managed legs as standard.

OPRE19... (LH or RH)	- 1900w x 1000d x 740h
-----------------------------	------------------------



OPC16RH

Optima Plus Fixed Height Crescent Workstation

- Standard lead times.
- 25mm top panel.
- Wire managed legs as standard.
- 600mm return.

OPC18... (LH or RH)	- 1800w x 1200d x 740h
OPC16... (LH or RH)	- 1600w x 1200d x 740h
OPC14... (LH or RH)	- 1400w x 1200d x 740h

Optima Plus

Fixed Height Workstations

MFC: Available in Ash, Autumn Cherry, Beech, Chester Oak, English Walnut, Grey, Grey Nebraska Oak, Laurentii Wenge, Natural Nebraska Oak and White
Veneer: Available in Oak and Walnut (*3 Week Lead Time*)
Edging: Add surcharge for Wenge, Black and Plywood Effect per top - *Edging on 25mm White MFC only*
Metalwork: Silver, Black Graphite and White - Add surcharge for Chrome Effect



OPCB18RH

Optima Plus Fixed Height Bow Fronted Crescent Workstation

- Standard lead times.
- 25mm top panel.
- Wire managed legs as standard.
- 600mm return.

OPCB18... (LH or RH) - 1800w x 1300d x 740h



OPRC19RH

Optima Plus Fixed Height Radius Crescent Workstation

- Standard lead times.
- 25mm top panel.
- Wire managed legs as standard.
- 600mm return.

OPRC19... (LH or RH) - 1900w x 1200d x 740h

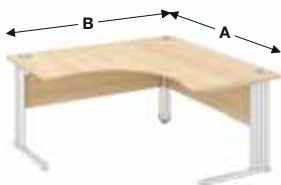

OPSC16A

Optima Plus Fixed Height Symmetrical Crescent Workstation

- Standard lead times.
- 25mm top panel.
- Wire managed legs as standard.
- 2x 800mm ends.
- The grain direction is shown as 'A' and 'B'.

OPSC18A - 1800w x 1800d x 740h
OPSC18B - 1800w x 1800d x 740h
OPSC16A - 1600w x 1600d x 740h
OPSC16B - 1600w x 1600d x 740h



OPW16RH

Optima Plus Fixed Height Single Wave Desk

- Standard lead times.
- 25mm top panel.
- Wire managed legs as standard.

OPW18... (LH or RH) - 1800w x 1000-800d x 740h
OPW16... (LH or RH) - 1600w x 1000-800d x 740h
OPW14... (LH or RH) - 1400w x 1000-800d x 740h
OPW12... (LH or RH) - 1200w x 1000-800d x 740h

OPW18/6... (LH or RH) - 1800w x 800-600d x 740h
OPW16/6... (LH or RH) - 1600w x 800-600d x 740h
OPW14/6... (LH or RH) - 1400w x 800-600d x 740h
OPW12/6... (LH or RH) - 1200w x 800-600d x 740h



OPDW16/9

Optima Plus Fixed Height Double Wave Desk

- Standard lead times.
- 25mm top panel.
- Wire managed legs as standard.

OPDW18/10 - 900d Centre - 1800w x 1000d x 740h
OPDW16/10 - 900d Centre - 1600w x 1000d x 740h

OPDW18/9 - 800d Centre - 1800w x 900d x 740h
OPDW16/9 - 800d Centre - 1600w x 900d x 740h

Optima Plus

Fixed Height and Linking Workstations

MFC:	Available in Ash, Autumn Cherry, Beech, Chester Oak, English Walnut, Grey, Grey Nebraska Oak, Laurentii Wenge, Natural Nebraska Oak and White
Veneer:	Available in Oak and Walnut (<i>3 Week Lead Time</i>)
Edging:	Add surcharge for Wenge, Black and Plywood Effect per top - <i>Edging on 25mm White MFC only</i>
Metalwork:	Silver, Black Graphite and White - Add surcharge for Chrome Effect



OP120

Optima Plus Fixed Height 120 Degree Workstation

- Standard lead times.
- 25mm top panel.
- Can be configured as a singular workstation or in modules of 3, 6, 9 etc.
- Wire managed legs as standard.

OP120 - 2078w (extreme) x 740h (1200w back edge x 800d return)

OP120/6 - 1732w (extreme) x 740h (1000w back edge x 600d return)



OPK20

Optima Plus Fixed Height Kidney Desk

- Standard lead times.
- 25mm top panel.
- Wire managed legs as standard.

OPK20 - 2000w (extreme) x 800d x 740h



OPRR18

Optima Plus Fixed Height Radius Reception Desk

- Standard lead times.
- 25mm top panel.
- Wire managed legs as standard.

OPRR20 - 2000w (extreme) x 800d x 740h

OPRR18 - 1800w (extreme) x 800d x 740h



OPRDRH

Optima Plus Fixed Height Reception Desk

- Standard lead times.
- 2x 25mm top panels.
- 850mm and 600mm ends are slightly curved.
- Wire managed legs as standard.

OPRD... (LH or RH) - 1850w (extreme) x 1800d x 740h



OPLW8/6

Optima Plus Fixed Height Linking Workstation

- Standard lead times.
- 25mm top panel.
- Links 800mm and 600mm deep desks.
- Wire managed legs as standard.

OPLW8/6 - Links 800d Ends - 1225w x 1225d x 740h

OPLW8/4 - Links 800d Ends - 1083w x 1083d x 740h

OPLW6 - Links 600d Ends - 1025w x 1025d x 740h

Optima Plus

Returns and Extensions

MFC: Available in Ash, Autumn Cherry, Beech, Chester Oak, English Walnut, Grey, Grey Nebraska Oak, Laurentii Wenge, Natural Nebraska Oak and White
Veneer: Available in Oak and Walnut (*3 Week Lead Time*)
Edging: Add surcharge for Wenge, Black and Plywood Effect per top - *Edging on 25mm White MFC only*
Metalwork: Silver, Black Graphite and White - Add surcharge for Chrome Effect



OPLU90R

Optima Plus Curved Linking Extension

- Standard lead times.
- 25mm top panel.
- Links 800mm deep workstations.

OPLU90R - Links 800d Ends - 800w x 800d x 740h



OPLU8L

Optima Plus Square Linking Extension

- Standard lead times.
- 25mm top panel.
- Links 800mm deep workstations.

OPLU8L - Links 800d Ends - 800w x 800d x 740h



OPSR10/6RH

Optima Plus Fixed Height Secretarial Return

- Standard lead times.
- 25mm top panel.
- Wire managed legs as standard.
- Compatible with rectangular, bow fronted rectangular and 'D' ended desks only.

OPSR10/6... (LH or RH) - 1000w x 600d x 740h



OPSCMT16

Optima Plus Meeting Extension

- Standard lead times.
- 25mm top panel.
- Complete with 120mm diameter support leg on 300mm diameter base.

OPSCMT16 - For 1600d Ends - 1600w x 660d x 740h

OPSCMT12 - For 1200d Ends - 1200w x 600d x 740h

OPSCMT8 - For 800d Ends - 800w x 600d x 740h

OPSCMT120 - For OP120 - 1600w x 660d x 740h

OPDWSCMT18 - For 900d Double Wave Desks - 1800w x 800d x 740h



OPDWSCMT

Optima Plus Meeting Extension

- Standard lead times.
- 25mm top panel.
- Complete with 2x 60mm diameter support legs.

OPDWSCMT - For 1000d Double Wave Desks - 2000w x 800d x 740h

Optima Plus

Accessories

Metalwork: Silver, Black Graphite and White - Add surcharge for Chrome Effect



OF9

Optima Plus Cable Tray

- Standard lead times.
- Cable trays are 100mm deep and 110mm high.
- For compatible desks, see below.



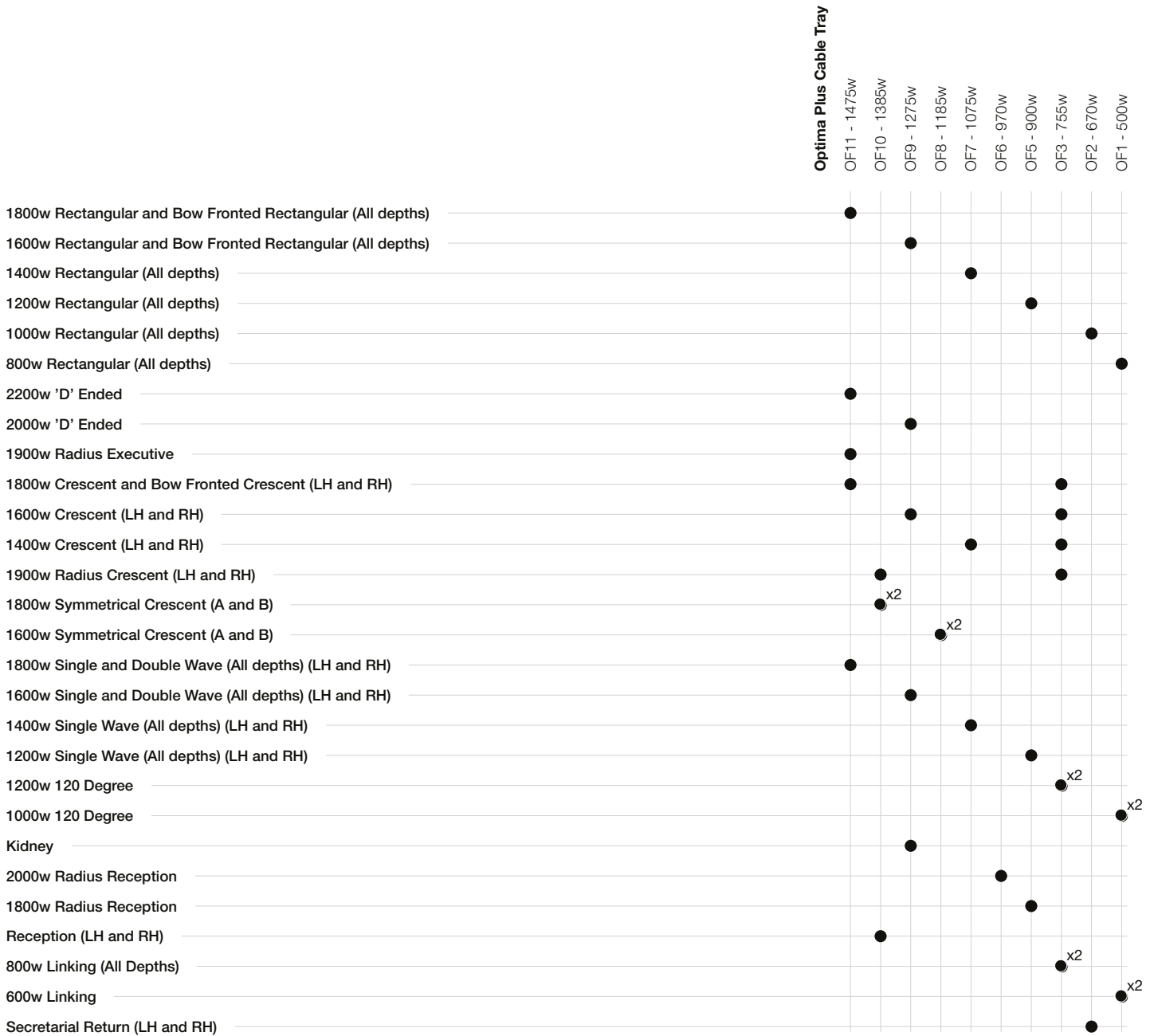

- OF11** - 1475w
- OF10** - 1385w
- OF9** - 1275w
- OF8** - 1185w
- OF7** - 1075w
- OF6** - 970w
- OF5** - 900w
- OF3** - 755w
- OF2** - 670w
- OF1** - 500w



Optima Plus

Featured Compatible Items and Compatibility Breakdown

Optima Plus Featured Compatible Items

				
<p>CPU Holder</p> <ul style="list-style-type: none"> Includes mounting kit. <p>CPU (Black) CPU/W (White)</p> <p>See page 310 for details.</p>	<p>Maya Monitor Arm</p> <ul style="list-style-type: none"> Clamp On and Bolt Through Desk Fixings. <p>MMA1/W (White) MMA1/B (Black)</p> <p>See page 306 for details.</p>	<p>Maya Dual Monitor Arm</p> <ul style="list-style-type: none"> Clamp On and Bolt Through Desk Fixings. <p>MMA2/W (White) MMA2/B (Black)</p> <p>See page 306 for details.</p>	<p>Maya Laptop Stand</p> <ul style="list-style-type: none"> Attaches onto Maya Monitor Arms. <p>MMA/LS/B (Black)</p> <p>See page 306 for details.</p>	<p>Slinky Cable Riser</p> <ul style="list-style-type: none"> Suitable for all desk ranges. <p>SCR/S (Silver) SCR/B (Black) SCR/W (White)</p> <p>See page 310 for details.</p>

Optima Plus Compatibility Breakdown

- **Black** - Compatible
- **Orange** - Non-standard position required
- **Blue** - Conflict when using screens without .../V

	Power and Data Modules															
	Kaspa, page 294	Prime, page 294	Boardroom, page 295	Conus, page 296	Peak, page 297	Escalate, page 297	Wireless Charging Unit, page 298	Port Hole, page 299	Pix, page 299	Pluto, page 300	Inca, page 300	Flex, page 301	Boost, page 301	Capsule, page 302	Plaza, page 303	Wieland Socket Boxes, page 303
Optima Plus - Rectangular, 'D' Ended and Radius Executive	●	●				●	●	●	●	●	●	●	●	●	●	●
Optima Plus - Bow Fronted Rectangular and Crescent	●	●				●	●	●	●	●	●	●	●	●	●	●
Optima Plus - Crescent, Radius Crescent and Symmetrical Crescent	●	●				●	●	●	●	●	●	●	●	●	●	●
Optima Plus - Single and Double Wave	●	●				●	●	●	●	●	●	●	●	●	●	●
Optima Plus - 120 Degree	●	●				●	●	●	●	●	●	●	●	●	●	●
Optima Plus - Kidney, Radius Reception and Reception	●	●				●	●	●	●	●	●	●	●	●	●	●
Optima Plus - Linking	●	●				●	●	●	●	●	●	●	●	●	●	●
Optima Plus - Secretarial Return								●	●			●		●		
Optima Plus - Meeting / Conference	●	●	●	●	●	●	●	●	●	●	●	●	●	●	●	●

Optima Plus

Conference Tables

MFC: Available in Ash, Autumn Cherry, Beech, Chester Oak, English Walnut, Grey, Grey Nebraska Oak, Laurentii Wenge, Natural Nebraska Oak and White
Veneer: Available in Oak and Walnut (3 Week Lead Time)
Edging: Add surcharge for Wenge, Black and Plywood Effect per top - Edging on 25mm White MFC only
Metalwork: Silver, Black Graphite and White - Add surcharge for Chrome Effect
Add surcharge for Praline, Olive Green, Atlantic Blue, Sapphire Blue, Mustard Yellow, Terracotta and Conker Brown (2 Week Lead Time)



OPCONF3

Optima Plus Double 'D' Ended Conference Table

• Standard lead times. • 25mm top panel. • 'I' frame leg configuration with modesty panel.

OPCONF3 - 4800w x 1200d x 740h
2x 1700mm and 1x 1400mm Sections - Seating up to 14 People



OPCONF2

Optima Plus Double 'D' Ended Conference Table

• Standard lead times. • 25mm top panel. • 'I' frame leg configuration with modesty panel.

OPCONF2 - 3400w x 1200d x 740h
2x 1700mm Sections - Seating up to 10 People



OPCONF1B

Optima Plus Double 'D' Ended Conference Table

• Standard lead times. • 25mm top panel. • 'I' frame leg configuration with modesty panel.

OPCONF1B - 2400w x 1200d x 740h
1x 2400mm Section - Seating up to 8 People

OPCONF1A - 2000w x 1200d x 740h
1x 2000mm Section - Seating up to 8 People

Optima Plus

Conference and Meeting Tables

MFC: Available in Ash, Autumn Cherry, Beech, Chester Oak, English Walnut, Grey, Grey Nebraska Oak, Laurentii Wenge, Natural Nebraska Oak and White
Veneer: Available in Oak and Walnut (3 Week Lead Time)
Edging: Add surcharge for Wenge, Black and Plywood Effect per top - Edging on 25mm White MFC only
Metalwork: Silver, Black Graphite and White - Add surcharge for Chrome Effect
Add surcharge for Praline, Olive Green, Atlantic Blue, Sapphire Blue, Mustard Yellow, Terracotta and Conker Brown (2 Week Lead Time)



OPCONF1CB

Optima Plus Double 'D' Ended Conference Table

- Standard lead times.
- 25mm top panel.
- 120mm diameter legs on 685mm diameter bases.

OPCONF1CB - 2400w x 1200d x 740h
1x 2400mm Section - Seating up to 8 People

OPCONF1CA - 2000w x 1200d x 740h
1x 2000mm Section - Seating up to 6 People



OPCONF1SB

Optima Plus Rectangular Conference Table

- Standard lead times.
- 25mm top panel.
- Supplied with MT01 bases.
- Wire managed base, 80mm aperture, located within the column.
- 100mm square column.
- Heavy duty weighted 505mm square x 15mm deep base.
- Levelling feet.

OPCONF1SB - 2400w x 1200d x 740h
1x 2400mm Section - Seating up to 8 People

OPCONF1SA - 2000w x 1200d x 740h
1x 2000mm Section - Seating up to 8 People



OPDDMT24

Optima Plus Double 'D' Ended Meeting Table

- Standard lead times.
- 25mm top panel.
- 'I' frame leg configuration with modesty panel.

OPDDMT26 - 2600w x 800d x 740h
OPDDMT24 - 2400w x 800d x 740h
OPDDMT22 - 2200w x 800d x 740h
OPDDMT20 - 2000w x 800d x 740h



OPDMT20

Optima Plus 'D' Ended Meeting Table

- Standard lead times.
- 25mm top panel.
- 'I' frame leg configuration with modesty panel.

OPDMT22 - 2200w x 800d x 740h
OPDMT20 - 2000w x 800d x 740h
OPDMT18 - 1800w x 800d x 740h
OPDMT16 - 1600w x 800d x 740h



OPRMT16

Optima Plus Rectangular Meeting Table

- Standard lead times.
- 25mm top panel.
- 'I' frame leg configuration with modesty panel.

OPRMT18 - 1800w x 800d x 740h
OPRMT16 - 1600w x 800d x 740h
OPRMT14 - 1400w x 800d x 740h
OPRMT12 - 1200w x 800d x 740h

Callisto

Fixed Height Workstations and Meeting



A simplistic design provides the structure of Callisto, supporting an almost invisible wire management system. Cables can be routed from the base of the leg upright via an attractive and removable cable riser, to an optional horizontal cable tray, to carry high capacity wires under the desk top. The simple and well-engineered design of Callisto, ensures a swift and efficient installation.



Callisto

Fixed Height Workstations

MFC:	Available in Ash, Autumn Cherry, Beech, Chester Oak, English Walnut, Grey, Grey Nebraska Oak, Laurentii Wenge, Natural Nebraska Oak and White
Veneer:	Available in Oak and Walnut (3 Week Lead Time)
Edging:	Add surcharge for Wenge, Black and Plywood Effect per top - Edging on 25mm White MFC only
Metalwork:	Silver, Black Graphite and White - Add surcharge for Chrome Effect



CR16

Callisto Rectangular Desk

- Standard lead times. • 25mm top panel.
- Horizontal cable clips and 2x vertical cable risers as standard.

CR18	- 1800w x 800d x 740h
CR16	- 1600w x 800d x 740h
CR14	- 1400w x 800d x 740h
CR12	- 1200w x 800d x 740h
CR10	- 1000w x 800d x 740h

CR18/6	- 1800w x 600d x 740h
CR16/6	- 1600w x 600d x 740h
CR14/6	- 1400w x 600d x 740h
CR12/6	- 1200w x 600d x 740h
CR10/6	- 1000w x 600d x 740h



CRB16

Callisto Bow Fronted Rectangular Desk

- Standard lead times. • 25mm top panel.
- Horizontal cable clips and 2x vertical cable risers as standard.

CRB18	- 1800w x 900d x 740h
CRB16	- 1600w x 900d x 740h



CR20DRH

Callisto 'D' Ended Desk

- Standard lead times. • 25mm top panel.
- Horizontal cable clips and 2x vertical cable risers as standard.

CR22D... (LH or RH)	- 2200w x 800d x 740h
CR20D... (LH or RH)	- 2000w x 800d x 740h



CRE19RH

Callisto Radius Executive Desk

- Standard lead times. • 25mm top panel.
- Horizontal cable clips and 2x vertical cable risers as standard.

CRE19... (LH or RH)	- 1900w x 1000d x 740h
----------------------------	------------------------



CC16RH

Callisto Crescent Workstation

- Standard lead times. • 25mm top panel.
- Horizontal cable clips and 2x vertical cable risers as standard. • 600mm return.

CC18... (LH or RH)	- 1800w x 1200d x 740h
CC16... (LH or RH)	- 1600w x 1200d x 740h
CC14... (LH or RH)	- 1400w x 1200d x 740h

Callisto

Fixed Height Workstations

MFC:	Available in Ash, Autumn Cherry, Beech, Chester Oak, English Walnut, Grey, Grey Nebraska Oak, Laurentii Wenge, Natural Nebraska Oak and White
Veneer:	Available in Oak and Walnut (<i>3 Week Lead Time</i>)
Edging:	Add surcharge for Wenge, Black and Plywood Effect per top - <i>Edging on 25mm White MFC only</i>
Metalwork:	Silver, Black Graphite and White - Add surcharge for Chrome Effect



CCB18RH

Callisto Bow Fronted Crescent Workstation

- Standard lead times. • 25mm top panel.
- Horizontal cable clips and 2x vertical cable risers as standard. • 600mm return.

CCB18... (LH or RH) - 1800w x 1300d x 740h



CRC19RH

Callisto Radius Crescent Workstation

- Standard lead times. • 25mm top panel.
- Horizontal cable clips and 2x vertical cable risers as standard. • 600mm return.

CRC19... (LH or RH) - 1900w x 1200d x 740h

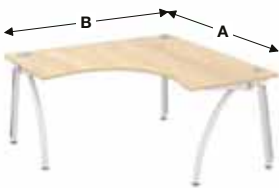

CSC16A

Callisto Symmetrical Crescent Workstation

- Standard lead times. • 25mm top panel.
- Horizontal cable clips and 2x vertical cable risers as standard. • 2x 800mm ends.
- The grain direction is shown as 'A' and 'B'.

CSC18A - 1800w x 1800d x 740h

CSC18B - 1800w x 1800d x 740h

CSC16A - 1600w x 1600d x 740h

CSC16B - 1600w x 1600d x 740h



CW16RH

Callisto Single Wave Desk

- Standard lead times. • 25mm top panel.
- Horizontal cable clips and 2x vertical cable risers as standard.

CW18... (LH or RH) - 1800w x 1000-800d x 740h

CW16... (LH or RH) - 1600w x 1000-800d x 740h

CW14... (LH or RH) - 1400w x 1000-800d x 740h

CW12... (LH or RH) - 1200w x 1000-800d x 740h

CW18/6... (LH or RH) - 1800w x 800-600d x 740h

CW16/6... (LH or RH) - 1600w x 800-600d x 740h

CW14/6... (LH or RH) - 1400w x 800-600d x 740h

CW12/6... (LH or RH) - 1200w x 800-600d x 740h



CDW16/9

Callisto Double Wave Desk

- Standard lead times. • 25mm top panel.
- Horizontal cable clips and 2x vertical cable risers as standard.

CDW18/10 - 900d Centre - 1800w x 1000d x 740h

CDW16/10 - 900d Centre - 1600w x 1000d x 740h

CDW18/9 - 800d Centre - 1800w x 900d x 740h

CDW16/9 - 800d Centre - 1600w x 900d x 740h

Callisto

Fixed Height Workstations, Extensions and Accessories

MFC:	Available in Ash, Autumn Cherry, Beech, Chester Oak, English Walnut, Grey, Grey Nebraska Oak, Laurentii Wenge, Natural Nebraska Oak and White
Veneer:	Available in Oak and Walnut (<i>3 Week Lead Time</i>)
Edging:	Add surcharge for Wenge, Black and Plywood Effect per top - <i>Edging on 25mm White MFC only</i>
Metalwork:	Silver, Black Graphite and White - Add surcharge for Chrome Effect



C120

Callisto 120 Degree Workstation

- Standard lead times. • 25mm top panel.
- Can be configured as a single workstation or in modules of 3, 6, 9, etc.
- Horizontal cable clips and 2x vertical cable risers as standard.

C120 - 2078w (extreme) x 740h (1200w back edge x 800d return)

C120/6 - 1732w (extreme) x 740h (1000w back edge x 600d return)



CK20

Callisto Kidney Desk

- Standard lead times. • 25mm top panel.
- Horizontal cable clips and 2x vertical cable risers as standard.

CK20 - 2000w (extreme) x 800d x 740h



CRR18

Callisto Radius Reception Desk

- Standard lead times. • 25mm top panel.
- Horizontal cable clips and 2x vertical cable risers as standard.

CRR20 - 2000w (extreme) x 800d x 740h

CRR18 - 1800w (extreme) x 800d x 740h



CRDRH

Callisto Reception Desk

- Standard lead times. • 2x 25mm top panels. • 850mm and 600mm ends are slightly curved.
- Horizontal cable clips and 2x vertical cable risers as standard.

CRD... (LH or RH) - 1850w (extreme) x 1800d x 740h



CSCMT16

Callisto Meeting Extension

- Standard lead times. • 25mm top panel. • Complete with fixing beams.

CSCMT16 - For 1600d Ends - 1600w x 660d x 740h

CSCMT12 - For 1200d Ends - 1200w x 600d x 740h

CSCMT8 - For 800d Ends - 800w x 600d x 740h

CSCMT120 - For C120 - 1600w x 660d x 740h



CMP16
Illustrated in red

Callisto Steel Modesty Panel

- Standard lead times. • Modesty panels are 400mm high.

CMP18 - For 1800w Workstations - 1400w

CMP16 - For 1600w Workstations - 1200w

CMP14 - For 1400w Workstations - 1000w

CMP12 - For 1200w Workstations - 800w

CMP10 - For 1000w Workstations - 600w

CRMP20 - For CRR20 - Curved

CRMP18 - For CRR18 - Curved

CKMP - For CK20 - Curved

Callisto

Accessories, Featured Compatible Items and Compatibility Breakdown

Metalwork: Silver, Black Graphite and White - Add surcharge for Chrome Effect



CWMT16
Illustrated in red

Callisto Cable Tray

- Standard lead times.
- High capacity cable tray to conceal power, data and telecom cables through a hinged tray.
- Cable trays are 130mm deep and 75mm high.

- CWMT18** - For 1800w Workstations - 1300w
- CWMT16** - For 1600w Workstations - 1100w
- CWMT14** - For 1400w Workstations - 900w
- CWMT12** - For 1200w Workstations - 700w
- CWMT10** - For 1000w Workstations - 500w

Callisto Featured Compatible Items



CPU Holder

- Includes mounting kit.

CPU (Black)
CPU/W (White)

See page 310 for details.



Maya Monitor Arm

- Clamp On and Bolt Through Desk Fixings.

MMA1/W (White)
MMA1/B (Black)

See page 306 for details.



Maya Dual Monitor Arm

- Clamp On and Bolt Through Desk Fixings.

MMA2/W (White)
MMA2/B (Black)

See page 306 for details.



Maya Laptop Stand

- Attaches onto Maya Monitor Arms.

MMA/LS/B (Black)

See page 306 for details.



Slinky Cable Riser

- Suitable for all desk ranges.

SCR/S (Silver)
SCR/B (Black)
SCR/W (White)

See page 310 for details.

Callisto Compatibility Breakdown

● **Black** - Compatible

● **Blue** - Conflict when using screens without .../V

	Power and Data Modules															
	Kaspa, page 294	Prime, page 294	Boardroom, page 295	Conus, page 296	Peak, page 297	Escalate, page 297	Wireless Charging Unit, page 298	Port Hole, page 299	Pix, page 299	Pluto, page 300	Inca, page 300	Flex, page 301	Boost, page 301	Capsule, page 302	Plaza, page 303	Wieland Socket Boxes, page 303
Callisto - Rectangular, 'D' Ended and Radius Executive	●	●				●	●	●	●	●	●	●	●	●	●	●
Callisto - Bow Fronted Rectangular and Crescent	●	●				●	●	●	●	●	●	●	●	●	●	●
Callisto - Crescent, Radius Crescent and Symmetrical Crescent	●	●				●	●	●	●	●	●	●	●	●	●	●
Callisto - Single and Double Wave	●	●				●	●	●	●	●	●	●	●	●	●	●
Callisto - 120 Degree	●	●				●	●	●	●	●	●	●	●	●	●	●
Callisto - Kidney, Radius Reception and Reception	●	●				●	●	●	●	●	●	●	●	●	●	●
Callisto - Linking	●	●				●	●	●	●	●	●	●	●	●	●	●
Callisto - Secretarial Return								●	●			●		●		
Callisto - Meeting / Conference	●	●	●	●	●	●	●	●	●	●	●	●	●	●	●	●

Callisto

Conference and Meeting Tables

MFC: Available in Ash, Autumn Cherry, Beech, Chester Oak, English Walnut, Grey, Grey Nebraska Oak, Laurentii Wenge, Natural Nebraska Oak and White
Veneer: Available in Oak and Walnut (3 Week Lead Time)
Edging: Add surcharge for Wenge, Black and Plywood Effect per top - Edging on 25mm White MFC only
Metalwork: Silver, Black Graphite and White - Add surcharge for Chrome Effect
Add surcharge for Praline, Olive Green, Atlantic Blue, Sapphire Blue, Mustard Yellow, Terracotta and Conker Brown (2 Week Lead Time)



CSCT



CSCTI

Callisto Segué Conference Table

• Standard lead times. • 25mm top panel. • 'A' frame style leg configuration. • Optional infill panel.

CSCT - 4830w (extreme) x 2470d (extreme) x 740h
6x Curved Sections and 2x Curved Corner Sections - Seating up to 16 People

CSCTI - Infill Panel Only



CSMT



CSMTI

Callisto Segué Meeting Table

• Standard lead times. • 25mm top panel. • 'A' frame style leg configuration. • Optional infill panel.

CSMT - 2830w (extreme) x 2755d (extreme) x 740h
3x Curved Sections and 3x Curved Corner Sections - Seating up to 12 People

CSMTI - Infill Panel Only



COCT24

Callisto Oval Conference Table

• Standard lead times. • 25mm top panel. • 'A' frame style leg configuration.

COCT24 - 2400w x 1200d x 740h
1x 2400mm Section - Seating up to 8 People

Windsor

Fixed Height Workstations and Meeting

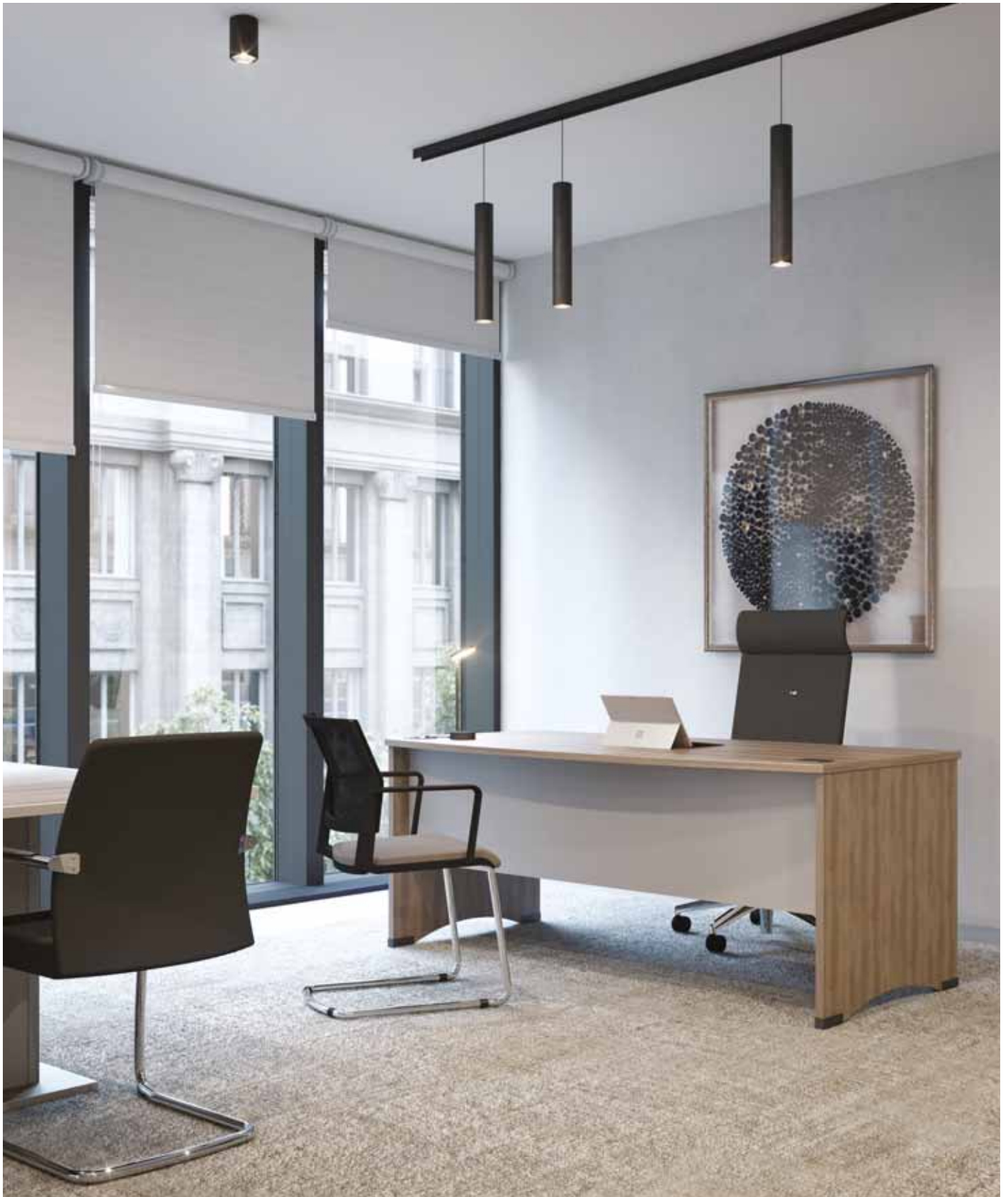

Windsor features panel ended workstations, delivering a distinct and executive finish. The traditional appearance offers a clean, premium feel within the set environment. Windsor offers a vast number of configurations and footprints meeting the demands of a flexible workspace. These include single desks, managerial workstations, reception units and meeting and conference tables.



Windsor

Fixed Height Workstations

MFC: Available in Ash, Autumn Cherry, Beech, Chester Oak, English Walnut, Grey, Grey Nebraska Oak, Laurentii Wenge, Natural Nebraska Oak and White
Veneer: Available in Oak and Walnut (*3 Week Lead Time*)
Edging: Add surcharge for Wenge, Black and Plywood Effect per top - *Edging on 25mm White MFC only*
Metalwork: Silver



WR16

Windsor Rectangular Desk

- Standard lead times. • 25mm top panel.

WR18 - 1800w x 800d x 740h
WR16 - 1600w x 800d x 740h
WR14 - 1400w x 800d x 740h
WR12 - 1200w x 800d x 740h
WR10 - 1000w x 800d x 740h



WRB16

Windsor Bow Fronted Rectangular Desk

- Standard lead times. • 25mm top panel.

WRB18 - 1800w x 900d x 740h
WRB16 - 1600w x 900d x 740h



WC16RH

Windsor Crescent Workstation

- Standard lead times. • 25mm top panel. • 600mm return.

WC18... (LH or RH) - 1800w x 1200d x 740h
WC16... (LH or RH) - 1600w x 1200d x 740h
WC14... (LH or RH) - 1400w x 1200d x 740h



Windsor

Fixed Height Workstations, Returns and Extensions

MFC: Available in Ash, Autumn Cherry, Beech, Chester Oak, English Walnut, Grey, Grey Nebraska Oak, Laurentii Wenge, Natural Nebraska Oak and White
Veneer: Available in Oak and Walnut (3 Week Lead Time)
Edging: Add surcharge for Wenge, Black and Plywood Effect per top - Edging on 25mm White MFC only
Metalwork: Silver, Black Graphite and White



WCB18RH

Windsor Bow Fronted Crescent Workstation

- Standard lead times.
- 25mm top panel.
- 600mm return.

WCB18... (LH or RH) - 1800w x 1300d x 740h



WW16RH

Windsor Single Wave Desk

- Standard lead times.
- 25mm top panel.

WW18... (LH or RH) - 1800w x 1000-800d x 740h

WW16... (LH or RH) - 1600w x 1000-800d x 740h

WW14... (LH or RH) - 1400w x 1000-800d x 740h

WW12... (LH or RH) - 1200w x 1000-800d x 740h



WDW16/9

Windsor Double Wave Desk

- Standard lead times.
- 25mm top panel.

WDW18/10 - 900d Centre - 1800w x 1000d x 740h

WDW16/10 - 900d Centre - 1600w x 1000d x 740h

WDW18/9 - 800d Centre - 1800w x 900d x 740h

WDW16/9 - 800d Centre - 1600w x 900d x 740h



WSR10/6RH

Windsor Secretarial Return

- Standard lead times.
- 25mm top panel.
- Compatible with rectangular desks and crescent workstations only.

WSR10/6... (LH or RH) - 1000w x 600d x 740h



WSCMT16

Windsor Meeting Extension

- Standard lead times.
- 25mm top panel.
- Complete with 120mm diameter support leg on 300mm diameter base.

WSCMT16 - For 1600d Ends - 1600w x 800d x 740h

WSCMT12 - For 1200d Ends - 1200w x 600d x 740h

WSCMT8 - For 800d Ends - 800w x 600d x 740h

WDWSCMT18 - For 900d Double Wave Desks - 1800w x 800d x 740h



WDWSCMT

Windsor Meeting Extension

- Standard lead times.
- 25mm top panel.
- Complete with 2x 60mm diameter support legs.

WDWSCMT - For 1000d Double Wave Desks - 2000w x 800d x 740h

Windsor

Fixed Height Reception Workstations and Counter Tops

MFC:	Available in Ash, Autumn Cherry, Beech, Chester Oak, English Walnut, Grey, Grey Nebraska Oak, Laurentii Wenge, Natural Nebraska Oak and White
Veneer:	Available in Oak and Walnut (<i>3 Week Lead Time</i>)
Edging:	Add surcharge for Wenge, Black and Plywood Effect per top - <i>Edging on 25mm White MFC only</i>
Metalwork:	Silver, Black Graphite and White



WRU18RH

Windsor Bow Fronted Reception Workstation

- Standard lead times.
- 25mm top panel.
- 600mm return.
- Desktop is 745mm high.

WRU20... (LH or RH) - 2000w x 1350d x 1100h

WRU18... (LH or RH) - 1800w x 1350d x 1100h



RRRH

Windsor Radius Reception Desk with DDA Extension

- Standard lead times.
- 25mm top panel.
- Designed for wheelchair visitor access.
- Complete with kick plate (stainless steel only).
- Delivered assembled.
- Desktop is 745mm high.

RR... (LH or RH) - 2800w (extreme) x 800d x 745h



RR

Windsor Radius Reception Desk

- Standard lead times.
- 25mm top panel.
- Complete with kick plate (stainless steel only).
- Delivered assembled.
- Desktop is 745mm high.

RR - 1915w (extreme) x 800d x 745h



DCT

Windsor Curved Double Counter Top

- Standard lead times.
- 25mm top panel.
- Windsor curved double counter top does not sit flush either end of Windsor radius reception desks due to its fixings.

DCT - 1800w (extreme) x 240d x 380h



SCT

Windsor Curved Single Counter Top

- Standard lead times.
- 25mm top panel.
- Windsor curved single counter top can be positioned left, centre or right of the reception desk.

SCT - 980w x 240d x 380h

Windsor

Accessories and Featured Compatible Items

Metalwork: Silver, Black Graphite and White



OF9
Illustrated in red

Windsor Cable Tray

- Standard lead times.
- Cable trays are 100mm deep and 110mm high.
- For compatible desks, see below.

- OF11** - 1475w
- OF9** - 1275w
- OF7** - 1075w
- OF5** - 900w
- OF3** - 755w
- OF2** - 670w

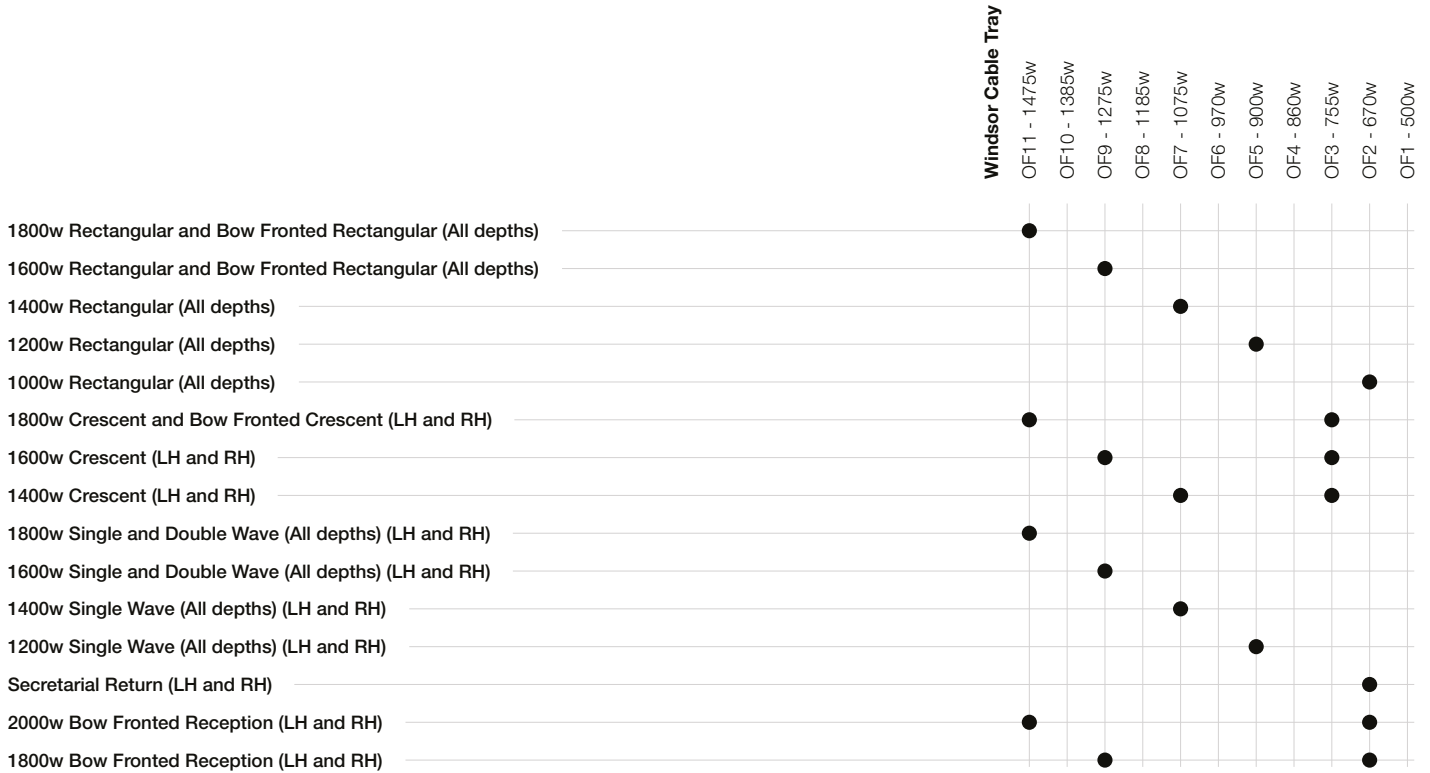

Windsor Featured Compatible Items



CPU Holder

- Includes mounting kit.

- CPU** (Black)
- CPU/W** (White)

See page 310 for details.



Maya Monitor Arm

- Clamp On and Bolt Through Desk Fixings.

- MMA1/W** (White)
- MMA1/B** (Black)

See page 306 for details.



Maya Dual Monitor Arm

- Clamp On and Bolt Through Desk Fixings.

- MMA2/W** (White)
- MMA2/B** (Black)

See page 306 for details.



Maya Laptop Stand

- Attaches onto Maya Monitor Arms.

- MMA/LS/B** (Black)

See page 306 for details.



Slinky Cable Riser

- Suitable for all desk ranges.

- SCR/S** (Silver)
- SCR/B** (Black)
- SCR/W** (White)

See page 310 for details.

Windsor

Compatibility Breakdown and Conference Tables

MFC: Available in Ash, Autumn Cherry, Beech, Chester Oak, English Walnut, Grey, Grey Nebraska Oak, Laurentii Wenge, Natural Nebraska Oak and White
Veneer: Available in Oak and Walnut (3 Week Lead Time)
Edging: Add surcharge for Wenge, Black and Plywood Effect per top - Edging on 25mm White MFC only
Metalwork: Silver, Black Graphite and White

Windsor Compatibility Breakdown

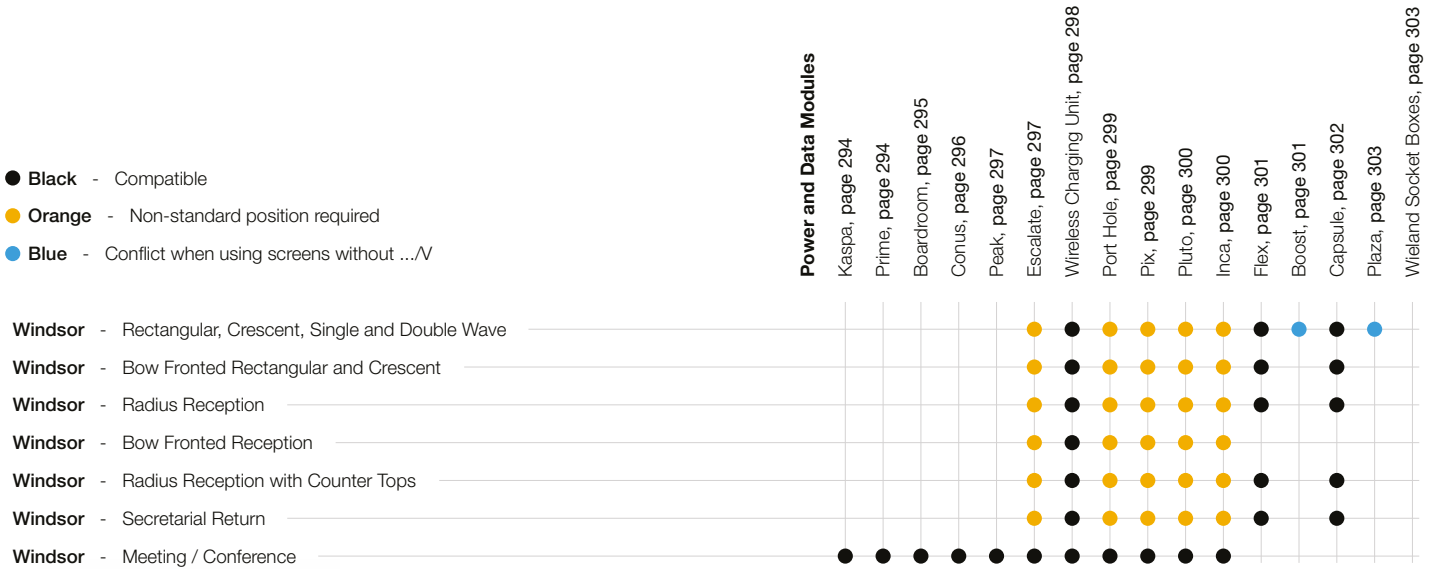

CONF2AL

Windsor Double 'D' Ended Conference Table

• Standard lead times. • 25mm top panel. • Arrowhead leg configuration with modesty panel.

CONF2AL - 3400w x 1200d x 740h
 2x 1700mm Sections - Seating up to 10 People



DDT24

Windsor Double 'D' Ended Conference Table

• Standard lead times. • 25mm top panel. • Arrowhead leg configuration with modesty panel.

DDT24 - 2400w x 1200d x 740h
 1x 2400mm Section - Seating up to 8 People



OVT24

Windsor Oval Conference Table

• Standard lead times. • 25mm top panel. • Arrowhead leg configuration with modesty panel.

OVT24 - 2400w x 1200d x 740h
 1x 2400mm Section - Seating up to 8 People



BST24

Windsor Barrel Conference Table

• Standard lead times. • 25mm top panel. • Arrowhead leg configuration with modesty panel.

BST24 - 2400w x 1200d x 740h
 1x 2400mm Section - Seating up to 8 People

Flexi

Fixed Height Workstations



The Flexi range offers a slimline frame with a double upright cantilever leg. The range has been designed and engineered to offer a robust and durable solution. The leg frames are supported by an MFC modesty panel, integral to the structural integrity of the range. Vertical leg risers are compatible with the range to accommodate cables from the floor to the underside of the work surface. An optional horizontal cable tray can be positioned to the inside or outside of the modesty panel. This tray caters for cables under the work surface and access to the desktop via cable ports.



Flexi

Fixed Height Workstations

MFC: Available in Ash, Autumn Cherry, Beech, Chester Oak, English Walnut, Grey, Grey Nebraska Oak, Laurentii Wenge, Natural Nebraska Oak and White
Edging: Add surcharge for Wenge, Black and Plywood Effect per top - *Edging on 25mm White MFC only*
Metalwork: Silver, Black Graphite and White



FR16

Flexi Rectangular Desk

- Standard lead times. • 25mm top panel.

FR18	- 1800w x 800d x 740h
FR16	- 1600w x 800d x 740h
FR14	- 1400w x 800d x 740h
FR12	- 1200w x 800d x 740h
FR10	- 1000w x 800d x 740h
FR8	- 800w x 800d x 740h

FR18/6	- 1800w x 600d x 740h
FR16/6	- 1600w x 600d x 740h
FR14/6	- 1400w x 600d x 740h
FR12/6	- 1200w x 600d x 740h
FR10/6	- 1000w x 600d x 740h
FR8/6	- 800w x 600d x 740h



FC16RH

Flexi Crescent Workstation

- Standard lead times. • 25mm top panel. • 600mm return.

FC18... (LH or RH)	- 1800w x 1200d x 740h
FC16... (LH or RH)	- 1600w x 1200d x 740h
FC14... (LH or RH)	- 1400w x 1200d x 740h

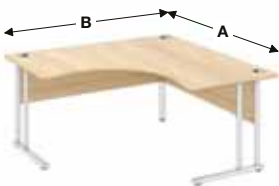

FSC16A

Flexi Symmetrical Crescent Workstation

- Standard lead times. • 25mm top panel. • 2x 800mm ends. • The grain direction is shown as 'A' and 'B'.

FSC18A	- 1800w x 1800d x 740h
FSC18B	- 1800w x 1800d x 740h
FSC16A	- 1600w x 1600d x 740h
FSC16B	- 1600w x 1600d x 740h



FW16RH

Flexi Single Wave Desk

- Standard lead times. • 25mm top panel.

FW18... (LH or RH)	- 1800w x 1000-800d x 740h
FW16... (LH or RH)	- 1600w x 1000-800d x 740h
FW14... (LH or RH)	- 1400w x 1000-800d x 740h
FW12... (LH or RH)	- 1200w x 1000-800d x 740h

FW18/6... (LH or RH)	- 1800w x 800-600d x 740h
FW16/6... (LH or RH)	- 1600w x 800-600d x 740h
FW14/6... (LH or RH)	- 1400w x 800-600d x 740h
FW12/6... (LH or RH)	- 1200w x 800-600d x 740h



FDW16/9

Flexi Double Wave Desk

- Standard lead times. • 25mm top panel.

FDW18/9	- 800d Centre - 1800w x 900d x 740h
FDW16/9	- 800d Centre - 1600w x 900d x 740h

Flexi

Fixed Height Workstations, Linking, Returns, Pedestals and Accessories

MFC: Available in Ash, Autumn Cherry, Beech, Chester Oak, English Walnut, Grey, Grey Nebraska Oak, Laurentii Wenge, Natural Nebraska Oak and White
Edging: Add surcharge for Wenge, Black and Plywood Effect per top - *Edging on 25mm White MFC only*
Metalwork: Silver, Black Graphite and White



F120

Flexi 120 Degree Workstation

- Standard lead times.
- 25mm top panel.
- Can be a single workstation or configured as a 3, 6, 9, etc. person module.

F120 - 2078w (extreme) x 740h (1200w back edge x 800d return)

F120/6 - 1732w (extreme) x 740h (1000w back edge x 600d return)



FLW8/6

Flexi Linking Workstation

- Standard lead times.
- 25mm top panel.
- Links 800mm and 600mm deep desks.

FLW8/6 - Links 800d Ends - 1225w x 1225d x 740h

FLW8/4 - Links 800d Ends - 1083w x 1083d x 740h

FLW6 - Links 600d Ends - 1025w x 1025d x 740h



FSR10/6RH

Flexi Secretarial Return for Rectangular Desks

- Standard lead times.
- 25mm top panel.
- Compatible with rectangular desks only.

FSR10/6... (LH or RH) - 1000w x 600d x 740h



FFPF

2 Drawer Fixed Under Desk Pedestal

- Standard lead times.
- Lockable, includes 2x keys.
- Alternative handles available (page 222).
- Compatible with 800mm deep Flexi rectangular desking only.

1x Single and 1x Filing Drawer

FFPF - 418w x 600d x 430h



FFP3

3 Drawer Fixed Under Desk Pedestal

- Standard lead times.
- Lockable, includes 2x keys.
- Alternative handles available (page 222).
- Compatible with 800mm deep Flexi rectangular desking only.

3x Single Drawers

FFP3 - 418w x 600d x 430h



FLCR

Flexi Cable Risers

- Standard lead times.
- Can be retrofitted.
- Single channel cable riser.
- Sold in pairs.

FLCR

Flexi

Accessories

Metalwork: Silver, Black Graphite and White



Flexi Cable Clip

- Standard lead times.
- Three channel cable clip allows Flexi desking to comply with BS6396 electrical standards.
- Easy clip-on mount.
- Grey plastic finish.

FCC

FCC



Flexi Cable Tray

- Standard lead times.
- Cable trays are 100mm deep and 110mm high.
- For compatible desks, see below.

- OF11** - 1475w
- OF9** - 1275w
- OF7** - 1075w
- OF5** - 900w
- OF3** - 755w
- OF2** - 670w
- OF1** - 500w

OF9

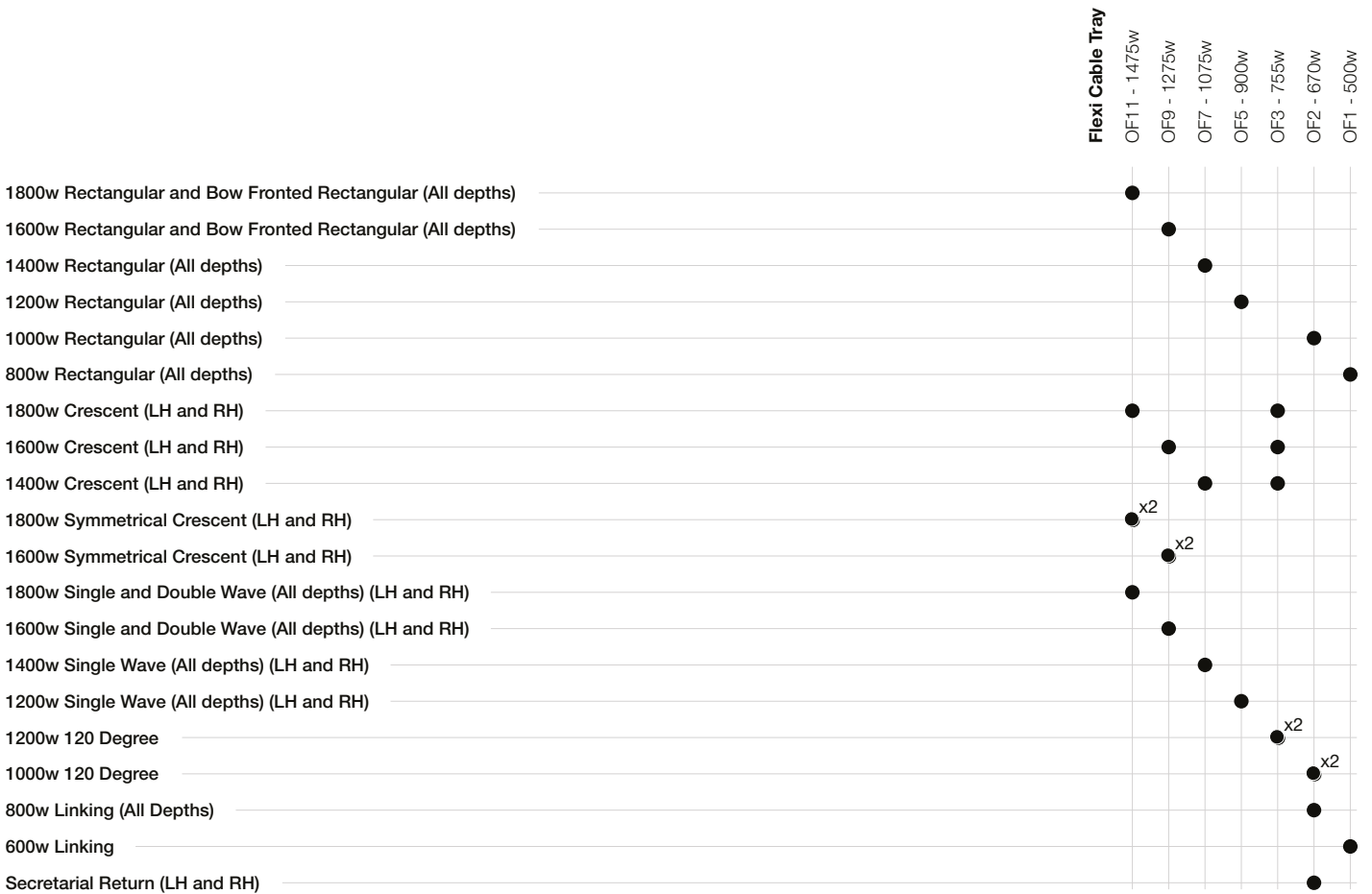

Flexi

Featured Compatible Items and Compatibility Breakdown

Flexi Featured Compatible Items



CPU Holder

- Includes mounting kit.

CPU (Black)

CPU/W (White)

See page 310 for details.



Maya Monitor Arm

- Clamp On and Bolt Through Desk Fixings.

MMA1/W (White)

MMA1/B (Black)

See page 306 for details.



Maya Dual Monitor Arm

- Clamp On and Bolt Through Desk Fixings.

MMA2/W (White)

MMA2/B (Black)

See page 306 for details.



Maya Laptop Stand

- Attaches onto Maya Monitor Arms.

MMA/LS/B (Black)

See page 306 for details.



Slinky Cable Riser

- Suitable for all desk ranges.

SCR/S (Silver)

SCR/B (Black)

SCR/W (White)

See page 310 for details.

Flexi Compatibility Breakdown

● **Black** - Compatible

● **Blue** - Conflict when using screens without .../V

● **Green** - Unspecified

Flexi - Rectangular, Crescent and Symmetrical Crescent

Flexi - Single and Double Wave and 120 Degree

Flexi - Secretarial Return

Flexi - Linking

	Power and Data Modules	Kaspa, page 294	Prime, page 294	Boardroom, page 295	Conus, page 296	Peak, page 297	Escalate, page 297	Wireless Charging Unit, page 298	Port Hole, page 299	Pix, page 299	Pluto, page 300	Inca, page 300	Flex, page 301	Boost, page 301	Capsule, page 302	Plaza, page 303	Wieland Socket Boxes, page 303
Flexi - Rectangular, Crescent and Symmetrical Crescent							● Green	● Black	● Black	● Black	● Black	● Black	● Black	● Blue	● Black	● Blue	
Flexi - Single and Double Wave and 120 Degree							● Green	● Black	● Black	● Black	● Black	● Black	● Black	● Blue	● Black	● Blue	
Flexi - Secretarial Return								● Black	● Black	● Black	● Black	● Black	● Black		● Black		
Flexi - Linking								● Black	● Black	● Black	● Black	● Black	● Black		● Black		

Desk Extensions

Universal Desktop Meeting Extensions



Extension tables are the perfect solution for extending existing desk space, to suit informal meetings. Within the modular tables portfolio, we offer six variations including a bow, circular, standard and teardrop shaped top, supported by a circular steel base. An eclipse shaped unit is available for radius executive and radius crescent desks, with a static circular steel base.



Desk Extensions

Extension Meeting Tables

MFC:	Available in Ash, Autumn Cherry, Beech, Chester Oak, English Walnut, Grey, Grey Nebraska Oak, Laurentii Wenge, Natural Nebraska Oak and White
Veneer:	Available in Oak and Walnut (3 Week Lead Time)
Edging:	Add surcharge for Wenge, Black and Plywood Effect per top - Edging on 25mm White MFC only
Metalwork:	Silver, Black Graphite and White - Add surcharge for Chrome Effect and Raw



BEXTLH

Bow Extension Meeting Table

- Standard lead times.
- 25mm top panel.
- 90mm diameter leg on 300mm diameter base.
- Not compatible with Linena and Matrix+ ranges.

BEXT... (LH or RH) - 950w x 1160d x 740h

Compatibility: For use with the Windsor range (suffix .../X)
For use with all other compatible ranges (no suffix)



CMT12

Circular Meeting Table

- Standard lead times.
- 25mm top panel.
- 90mm diameter leg on 300mm diameter base.
- Not compatible with Linena and Matrix+ ranges.

CMT12 - 1200w (dia) x 740h

Compatibility: For use with the Windsor range (suffix .../X)
For use with all other compatible ranges (no suffix)



DEXTLH

'D' Ended Extension Meeting Table

- Standard lead times.
- 25mm top panel.
- 90mm diameter leg on 300mm diameter base.
- Not compatible with Linena and Matrix+ ranges.

DEXT... (LH or RH) - 1600w x 800d x 740h

Compatibility: For use with the Windsor range (suffix .../X)
For use with all other compatible ranges (no suffix)



TD12LH

Teardrop Ended Extension Meeting Table

- Standard lead times.
- 25mm top panel.
- 90mm diameter leg on 300mm diameter base.
- Not compatible with Linena and Matrix+ ranges.

TD12... (LH or RH) - 1200w (dia) x 740h

TD09... (LH or RH) - 900w (dia) x 740h

Compatibility: For use with the Windsor range (suffix .../X)
For use with all other compatible ranges (no suffix)



SET10

Static Eclipse Extension Meeting Table

- Standard lead times.
- 25mm top panel.
- 90mm diameter leg on 300mm diameter base.
- Compatible with radius executive and radius crescent desking only.

SET10 - 1000w (dia) x 740h

SET09 - 900w (dia) x 740h

Call Centre

Fixed Height Workstations, Storage and Screens



Call Centre offers a highly functional solution, supported by a full steel sub-frame, offering significant levels of strength and stability. The product features a central hub capable of housing complex, high capacity cable installations that can be easily accessed via removable steel panels. The system is practical, flexible and delivers multiple workstations in clusters for improved communication. There are six configurations available for 3, 4, 5, 6 or 8 users. Pedestals can be located over the horizontal section of the supporting leg frames and screen panels are compatible and available in MFC and fabric options to provide privacy, if required. A full range of accessories are compatible including CPU holders, and desktop electrics.



Call Centre

Fixed Height Call Centres

MFC: Available in Ash, Autumn Cherry, Beech, Chester Oak, English Walnut, Grey, Grey Nebraska Oak, Laurentii Wenge, Natural Nebraska Oak and White
Edging: Add surcharge for Wenge, Black and Plywood Effect per top - *Edging on 25mm White MFC only*
Metalwork: Silver, Black Graphite and White



8CC

8 Person Circular Call Centre

- Standard lead times.
- 25mm top panel.
- 8 piece top.
- Each workspace segment measures 1200w x 1020d.

8CC - 3135w (extreme) x 3135d (extreme) x 725h



6CC

6 Person Circular Call Centre

- Standard lead times.
- 25mm top panel.
- 6 piece top.
- Each workspace segment measures 1460w x 950d.

6CC - 2920w (extreme) x 2660d (extreme) x 725h



5CC

5 Person Circular Call Centre

- Standard lead times.
- 25mm top panel.
- 5 piece top.
- Each workspace segment measures 1655w x 860d.

5CC - 2720w (extreme) x 2625d (extreme) x 725h



4CC

4 Person Circular Call Centre

- Standard lead times.
- 25mm top panel.
- 4 piece top.
- Each workspace segment measures 1920w x 796d.

4CC - 2710w (extreme) x 2710d (extreme) x 725h



4CCH

4 Person Semi-Circular Call Centre

- Standard lead times.
- 25mm top panel.
- 4 piece top.
- Each workspace segment measures 1200w x 1020d.
- Designed to be positioned against a wall.
- This model will only accept 3x Call Centre pedestals.

4CCH - 3135w (extreme) x 1568d (extreme) x 725h



3CCH

3 Person Semi-Circular Call Centre

- Standard lead times.
- 25mm top panel.
- 3 piece top.
- Each workspace segment measures 1460w x 950d.
- Designed to be positioned against a wall.
- This model will only accept 2x Call Centre pedestals.

3CCH - 2920w (extreme) x 1330d (extreme) x 725h

Call Centre

Pedestals

MFC: Available in Ash, Autumn Cherry, Beech, Chester Oak, English Walnut, Grey, Grey Nebraska Oak, Laurentii Wenge, Natural Nebraska Oak and White
Metalwork: Silver, Black Graphite and White



CCMPO

Call Centre Open Fronted Narrow Mobile Pedestal

- Standard lead times.
- 25mm top panel.
- Fits over Call Centre legs.
- Open fronted for PC tower storage.
- Ventilated back panel.

Open Fronted

CCMPO - 298w x 600d x 640h



CCMPF

Call Centre 3 Drawer Narrow Mobile Pedestal

- Standard lead times.
- 25mm top panel.
- Fits over Call Centre legs.
- Lockable, includes 2x keys.
- Alternative handles available (page 222).

2x Single and 1x Filing Drawers

CCMPF - 298w x 600d x 640h



CCMP4

Call Centre 4 Drawer Narrow Mobile Pedestal

- Standard lead times.
- 25mm top panel.
- Fits over Call Centre legs.
- Lockable, includes 2x keys.
- Alternative handles available (page 222).

4x Single Drawers

CCMP4 - 298w x 600d x 640h



Fixing Plate

Internal Power Module Fixing Plate

- Included as standard on each desk position.
- Can accommodate 2x power modules and 4x data / telecommunication sockets.
- Power modules and data sockets are not included as standard (page 125).



Call Centre

Accessories and Compatibility Breakdown



SK3/U/CC

Wieland Socket Box

- Standard lead times.
- Compatible with Call Centre workstations only.
- 3.15 amp Individually fused unswitched black sockets.
- Complete with 250mm earth lead to M5 ring terminal.
- Requires a separate mains lead if connecting directly into a socket (see below).

SK2/U/CC - 2 Gang - Black

SK3/U/CC - 3 Gang - Black



RJ45/3M

Data / Telecommunication Cable

- Standard lead times.

RJ45/3M - RJ45 Data Cable with 3m Flylead



5M

Wieland Mains Cable

- Standard lead time.
- Black cable and plug.
- 13amp fused.

7M - 7000w

5M - 5000w

3M - 3000w

2M - 2000w



CL10

Wieland Interconnection Cable

- Standard lead time.
- Black cable and interconnection plugs.
- Male and female connectors.

CL20 - 2000w

CL10 - 1000w

CL5 - 500w



IEC90/5

IEC 90 Degree Power Cable

- Standard lead time.
- Black cable and plug.
- 13amp fused.

IEC90/7 - 7000w

IEC90/5 - 5000w

IEC90/3 - 3000w

IEC90/2 - 2000w

Call Centre Compatibility Breakdown

● **Black** - Compatible

Call Centre - Circular and Semi-circular

Power and Data Modules	Compatibility
Kaspa, page 294	
Prime, page 294	
Boardroom, page 295	
Conus, page 296	
Peak, page 297	
Escalate, page 297	●
Wireless Charging Unit, page 298	●
Port Hole, page 299	●
Pix, page 299	●
Pluto, page 300	●
Inca, page 300	●
Flex, page 301	●
Boost, page 301	●
Capsule, page 302	●
Plaza, page 303	●
Wieland Socket Boxes, page 303	●

Call Centre

Desk Mounted System, Acoustic and Contract Screens

Fabric: Fully upholstered surface - *See below for pricing groups*
MFC: Available in Ash, Autumn Cherry, Beech, Chester Oak, English Walnut, Grey, Grey Nebraska Oak, Laurentii Wenge, Natural Nebraska Oak and White
Metalwork: Anodised Silver, Black Graphite and White
Fabric Groups: Group 1 - Add surcharge for Group 2-7



ECCSSC/F



Fabric Finish

Elite Desk Mounted System Screen for Call Centres

- Standard lead time. • Curved or wave dividing screens.
- Screen is bracketed to the centre console. • Link post not required.

Curved System Screen

ECCSSC/F - 1070w x 27d x 400-200h

Wave System Screen

ECCSSW/F - 1070w x 27d x 400-200h



ACCCSC/F



Fabric Finish

Elite Desk Mounted Acoustic Screen for Call Centres

- Standard lead time. • Curved and wave dividing screens faced with 6mm polyester fibre insulation board.
- Screen is bracketed to the centre console. • Link post not required.
- Class B certified in accordance with International Standards: ISO 354:2003, ISO 11654:1997 and ISO 9613-1:1993

Curved Acoustic Screen

ACCCSC/F - 1070w x 38d x 400-200h

Wave Acoustic Screen

ACCCSW/F - 1070w x 38d x 400-200h



CCCSC/F



Fabric Finish

Call Centre Desk Mounted Contract Screen for Call Centres

- Standard lead time. • Curved or wave dividing screens.
- Screen is bracketed to the centre console. • Link post not required.

Curved Contract Screen

CCCSC/F - 1070w x 27d x 400-200h

Wave Contract Screen

CCCSW/F - 1070w x 27d x 400-200h



CCSC/MFC



MFC Finish

Call Centre Desk Mounted Contract Screen for Call Centres

- Standard lead time. • Curved or wave dividing screens.
- Screen is bracketed to the centre console. • Link post not required.

Curved Contract Screen

CCSC/MFC - 1070w x 25d x 400-200h

Wave Contract Screen

CCSW/MFC - 1070w x 25d x 400-200h

Interact

Fixed Height Collaborative Tables



With the emerging trend to promote collaborative working, the aim of Interact is to provide you with an agile, dynamic and interactive workspace solution that benefits from easy and reliable connectivity of all personal devices and meets the high standard expected from workspace furniture today. Interact creates a positive first impression with customers and an area to share visual information with clients and colleagues. In addition, it provides technology enabled boardroom environments where colleagues can discuss ideas and collaborate around a shared screen and instant meeting spaces with no impact on existing infrastructure. The business and education community are embracing the collaborative approach as part of their agile working methods, with the possibility of accommodating between 4 and 10 people. The primary focus being around improving the productivity of meetings.



MFC: Available in Ash, Autumn Cherry, Beech, Chester Oak, English Walnut, Grey, Grey Nebraska Oak, Laurentii Wenge, Natural Nebraska Oak and White
Edging: Add surcharge for Wenge, Black and Plywood Effect per top - *Edging on 25mm White MFC only*
Metalwork: Silver, Black Graphite and White - Foot and Lower Support Rail in Black Graphite



IB08/L

Interact Blade Table

- 6 week lead time.
- 25mm top panel.
- Encourages group focus towards the screens.
- Two height options available (730mm and 1050mm).
- Optional CPU storage.
- Table top supplied with 80mm cable port for surface cable connectivity.
- 2x power included within the leg upright (2x 3.15a sockets).
- Secure TV bracket included and accommodates screens up to a maximum of 65".
- Standard interface plate provides four cable options (page 129).

- IB08/L** - For 8 People - 1445w x 2905d x 730h
IB06/L - For 6 People - 1420w x 2300d x 730h
IB04/L - For 4 People - 1420w x 1950d x 730h

- IB08/H** - For 8 People - 1445w x 2905d x 1050h
IB06/H - For 6 People - 1420w x 2300d x 1050h
IB04/H - For 4 People - 1420w x 1950d x 1050h



IP09/L

Interact Plectrum Table

- 6 week lead time.
- 25mm top panel.
- Ergonomically designed and promotes group focus.
- Two height options available (730mm and 1050mm).
- Optional CPU storage.
- Table top supplied with 80mm cable port for surface cable connectivity.
- 2x power included within the leg upright (2x 3.15a sockets).
- Secure TV bracket included and accommodates screens up to a maximum of 65".
- Standard interface plate provides four cable options (page 129).

- IP09/L** - For 9 People - 2028w x 3072d x 730h
IP06/L - For 6 People - 1440w x 1924d x 730h

- IP06/H** - For 6 People - 1440w x 1924d x 1050h



IQ08/L

Interact Quad Table

- 6 week lead time.
- 25mm top panel.
- Classic shape, ideal for face-to-face meetings.
- Two height options available (730mm and 1050mm).
- Optional CPU storage.
- Table top supplied with 80mm cable port for surface cable connectivity.
- 2x power included within the leg upright (2x 3.15a sockets).
- Secure TV bracket included and accommodates screens up to a maximum of 65".
- Standard interface plate provides four cable options (page 129).

- IQ10/L** - For 10 People - 1500w x 3661d x 730h
IQ08/L - For 8 People - 1020w x 3111d x 730h
IQ06/L - For 6 People - 1020w x 2421d x 730h
IQ04/L - For 4 People - 1020w x 1772d x 730h

- IQ10/H** - For 10 People - 1500w x 3661d x 1050h
IQ08/H - For 8 People - 1020w x 3111d x 1050h
IQ06/H - For 6 People - 1020w x 2421d x 1050h
IQ04/H - For 4 People - 1020w x 1772d x 1050h



Standard Data Interface Plate

Standard Data Interface Plate

- 1x power outlet
- 4x USB connections
- 1x switcher for connectivity leads within the desktop.



Standard Cable Port

Standard Cable Port

- Cables will be situated within the Interact table cable tray and will be accessible via the 80mm cable port.
- 4x connectivity leads within the desktop
- 1x space for on-board PC USB connections from PC if required.

Standard Configuration

- 1x HDMI
- 1x Mini Display Port
- 1x USB (Type C)
- 1x USB (Lightning)

Metalwork: Silver, Black Graphite and White



IQ08/L

Adjustable Non-Lockable CPU Holder

- 6 week lead time.
- Secures to the underside of the table.
- Width and height adjustable / non locking.
- Steel fabricated CPU holder.

I/CPU - 145-220w x 460d x 325-500h



IQ08/L

Adjustable Lockable CPU Holder

- 6 week lead time.
- Lockable, includes 2x keys.
- Client to provide CPU dimensions as this unit is manufactured to order requirements.
- Secures to the underside of the table.
- Steel fabricated CPU holder.
- High security lock.

I/CPUL

Interact Compatibility Breakdown

- **Black** - Compatible
- **Orange** - Non-standard position required
- **Blue** - Conflict when using screens without .../V
- **Purple** - Conflict when using cable tray
- **Green** - Unspecified
- **Red** - May not support larger modules

Interact - Blade, Plectrum and Quad

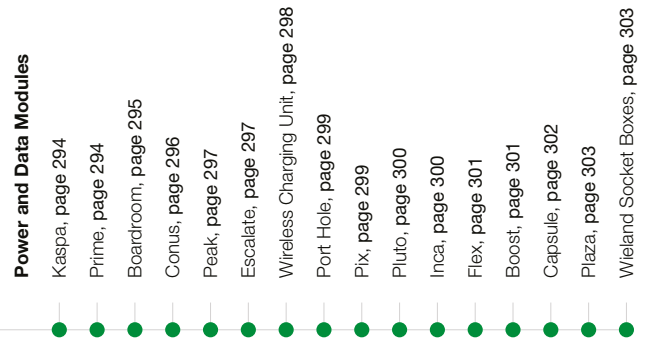

Reception

Connect and Windsor Ranges and Universal Shelves



For the environment your visitors first encounter, it's important the reception area captures your organisation's culture and vision. New to the Reception portfolio, Connect provides the freedom to create a unique arrangement that takes advantage of the space available, combining an alliance between the practicality and visual appearance of the reception desk. A range of 19 modular units, available in multiple configurations, naturally incorporates all the aspects needed to ensure compliance with accessibility and visitors of all capabilities.

For a less bespoke offering, our reception portfolio also offers 3 standalone units that take inspiration from the design of our core furniture range, Windsor.



Reception

Connect Examples

2 Week Lead Time

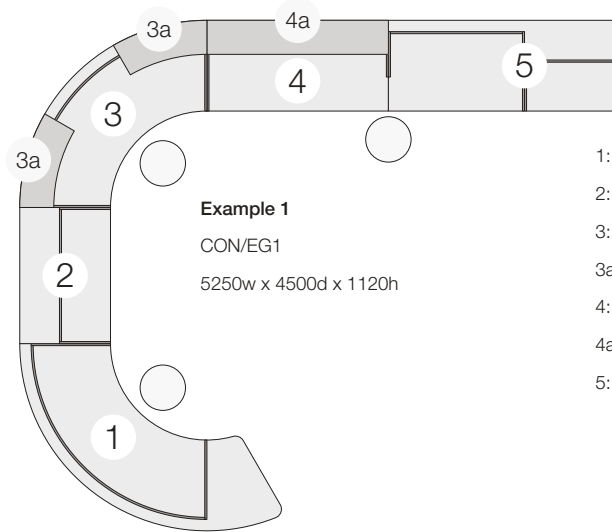

Example 1
CON/EG1
5250w x 4500d x 1120h

- | | | |
|-----|----------------|--|
| 1: | CONCV/AELH | Curved Workstation with Accessibility Extension |
| 2: | CONR12/AE | Rectangular Workstation with Accessibility Extension |
| 3: | CONCV | Curved Workstation |
| 3a: | CON/CTCV/T38 | Curved Third Counter Top |
| 4: | CONR16/INTLH | Rectangular Workstation with Inset Leg |
| 4a: | CON/CTR16/38 | Rectangular Counter Top |
| 5: | CONR20/INTASRH | Rectangular Workstation with Inset Leg and Accessibility Section |

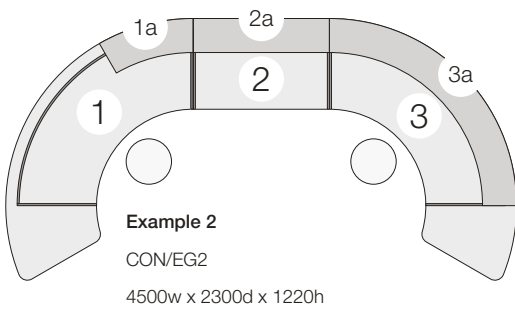

Example 2
CON/EG2
4500w x 2300d x 1220h

- | | | |
|-----|--------------|---|
| 1: | CONCV/AELH | Curved Workstation with Accessibility Extension |
| 1a: | CON/CTCV/T48 | Curved Third Counter Top |
| 2: | CONR12 | Rectangular Workstation |
| 2a: | CON/CTR12/48 | Rectangular Counter Top |
| 3: | CONCV/AERH | Curved Workstation with Accessibility Extension |
| 3a: | CON/CTCV/F48 | Curved Full Counter Top |

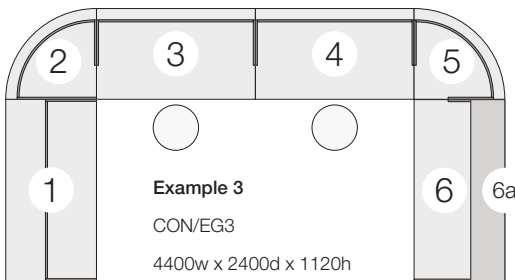

Example 3
CON/EG3
4400w x 2400d x 1120h

- | | | |
|-----|--------------|--|
| 1: | CONR16/AE | Rectangular Workstation with Accessibility Extension |
| 2: | CONCN/INTLH | Corner Workstation with Inset Leg |
| 3: | CONR14/INT | Rectangular Workstation with Inset Leg |
| 4: | CONR14/INT | Rectangular Workstation with Double Inset Legs |
| 5: | CONCN/INT | Corner Workstation with Double Inset Legs |
| 6: | CONR16/INTRH | Rectangular Workstation with Inset Leg |
| 6a: | CON/CTR16/38 | Rectangular Counter Top |

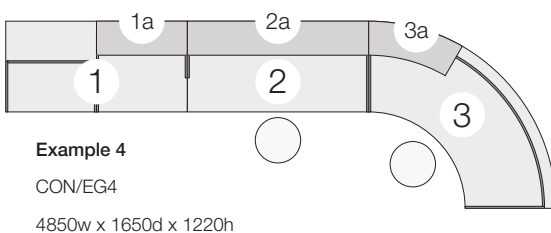

Example 4
CON/EG4
4850w x 1650d x 1220h

- | | | |
|-----|--------------|--|
| 1: | CONR16/ASLH | Rectangular Workstation with Inset Leg and Accessibility Section |
| 1a: | CON/CTR8/48 | Rectangular Counter Top |
| 2: | CONR16/INTRH | Rectangular Workstation with Inset Leg |
| 2a: | CON/CTR16/48 | Rectangular Counter Top |
| 3: | CONCV | Curved Workstation |
| 3a: | CON/CTCV/T48 | Curved Third Counter Top |

The dimensions illustrated in this document are not to scale. For accurate dimensions of any Elite product, please contact customer services.

MFC: Available in Ash, Autumn Cherry, Beech, Chester Oak, English Walnut, Grey, Grey Nebraska Oak, Laurentii Wenge, Natural Nebraska Oak and White
Nanotech: Available in Black (2 Week Lead Time)
Edging: Add surcharge for Wenge, Black and Plywood Effect per top - Edging on 25mm White MFC and Black Nanotech only
Metalwork: Silver, Black Graphite and White
 Add surcharge for Praline, Olive Green, Atlantic Blue, Sapphire Blue, Mustard Yellow, Terracotta and Conker Brown (2 Week Lead Time)



CONR16

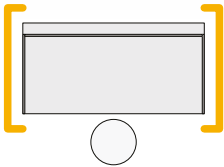

Connect Rectangular Reception Workstation

- 2 week lead time.
- 25mm top panel.
- Supplied with 2x full depth legs.
- Complete with kick plate (stainless steel only).
- Cable port access between workstations via legs.
- Compatible with DMSF/N/F... and DMSF/F... pedestals only (page 217).

- CONR20** - 2000w x 800d x 740h
- CONR18** - 1800w x 800d x 740h
- CONR16** - 1600w x 800d x 740h
- CONR14** - 1400w x 800d x 740h
- CONR12** - 1200w x 800d x 740h
- CONR10** - 1000w x 800d x 740h
- CONR8** - 800w x 800d x 740h

ORANGE - Can be attached to an adjoining workstation, be the end of sequence or be completely freestanding



CONR16/INT

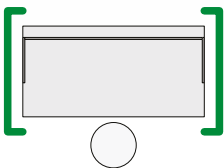

Connect Rectangular Reception Workstation with Double Inset Legs

- **This workstation must be attached to an adjoining workstation on both sides.**
- 2 week lead time.
- 25mm top panel.
- Supplied with 2x inset legs.
- Complete with kick plate (stainless steel only).
- Cable port access between workstations via legs.
- Compatible with DMSF/N/F... and DMSF/F... pedestals only (page 217).

- CONR20/INT** - 2000w x 800d x 740h
- CONR18/INT** - 1800w x 800d x 740h
- CONR16/INT** - 1600w x 800d x 740h
- CONR14/INT** - 1400w x 800d x 740h
- CONR12/INT** - 1200w x 800d x 740h
- CONR10/INT** - 1000w x 800d x 740h
- CONR8/INT** - 800w x 800d x 740h

GREEN - Must be attached to an adjoining workstation



CONR16/INTRH

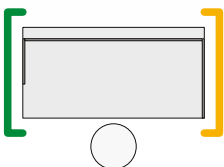

Connect Rectangular Reception Workstation with Inset Leg

- **This workstation must be attached to an adjoining workstation on its left side.**
- 2 week lead time.
- 25mm top panel.
- Supplied with 1x left side inset leg and 1x right side full depth leg.
- Complete with kick plate (stainless steel only).
- Cable port access between workstations via legs.
- Compatible with DMSF/N/F... and DMSF/F... pedestals only (page 217).

- CONR20/INTRH** - 2000w x 800d x 740h
- CONR18/INTRH** - 1800w x 800d x 740h
- CONR16/INTRH** - 1600w x 800d x 740h
- CONR14/INTRH** - 1400w x 800d x 740h
- CONR12/INTRH** - 1200w x 800d x 740h
- CONR10/INTRH** - 1000w x 800d x 740h
- CONR8/INTRH** - 800w x 800d x 740h

GREEN - Must be attached to an adjoining workstation

ORANGE - Can be attached to an adjoining workstation or be the end of sequence

MFC: Available in Ash, Autumn Cherry, Beech, Chester Oak, English Walnut, Grey, Grey Nebraska Oak, Laurentii Wenge, Natural Nebraska Oak and White
Nanotech: Available in Black (2 Week Lead Time)
Edging: Add surcharge for Wenge, Black and Plywood Effect per top - Edging on 25mm White MFC and Black Nanotech only
Metalwork: Silver, Black Graphite and White
 Add surcharge for Praline, Olive Green, Atlantic Blue, Sapphire Blue, Mustard Yellow, Terracotta and Conker Brown (2 Week Lead Time)



CONR16/INTLH

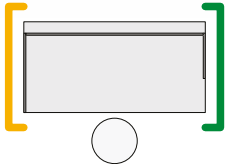

Connect Rectangular Reception Workstation with Inset Leg

- This workstation must be attached to an adjoining workstation on its right side.
- 2 week lead time. • 25mm top panel. • Supplied with 1x left side full depth leg and 1x right side inset leg.
- Complete with kick plate (stainless steel only). • Cable port access between workstations via legs.
- Compatible with DMSF/N/F... and DMSF/F... pedestals only (page 217).

CONR20/INTLH	- 2000w x 800d x 740h
CONR18/INTLH	- 1800w x 800d x 740h
CONR16/INTLH	- 1600w x 800d x 740h
CONR14/INTLH	- 1400w x 800d x 740h
CONR12/INTLH	- 1200w x 800d x 740h
CONR10/INTLH	- 1000w x 800d x 740h
CONR8/INTLH	- 800w x 800d x 740h

GREEN - Must be attached to an adjoining workstation

ORANGE - Can be attached to an adjoining workstation or be the end of sequence



CONR16/AE

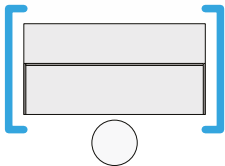

Connect Rectangular Reception Workstation with Accessibility Extension

- This workstation must be attached to an adjoining workstation with a full depth leg on at least one side.
- 2 week lead time. • 25mm top panel. • Compliant with the Equality Act. • Designed for wheelchair visitor access.
- Supplied with 2x AE legs. • Complete with kick plate (stainless steel only).
- Not compatible with Connect Rectangular Reception Counter Tops.

CONR20/AE	- 2000w x 800d x 740h
CONR18/AE	- 1800w x 800d x 740h
CONR16/AE	- 1600w x 800d x 740h
CONR14/AE	- 1400w x 800d x 740h
CONR12/AE	- 1200w x 800d x 740h
CONR10/AE	- 1000w x 800d x 740h
CONR8/AE	- 800w x 800d x 740h

BLUE - One side must be attached to an adjoining workstation



MFC: Available in Ash, Autumn Cherry, Beech, Chester Oak, English Walnut, Grey, Grey Nebraska Oak, Laurentii Wenge, Natural Nebraska Oak and White
Nanotech: Available in Black (2 Week Lead Time)
Edging: Add surcharge for Wenge, Black and Plywood Effect per top - Edging on 25mm White MFC and Black Nanotech only
Metalwork: Silver, Black Graphite and White
 Add surcharge for Praline, Olive Green, Atlantic Blue, Sapphire Blue, Mustard Yellow, Terracotta and Conker Brown (2 Week Lead Time)



CONR16/ASRH

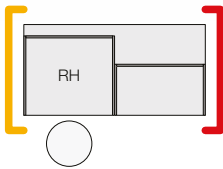

Connect Rectangular Reception Workstation with Accessibility Section

- 2 week lead time. • 25mm top panel. • Compliant with the Equality Act. • Designed for wheelchair visitor access.
- Supplied with 1x AE leg and 2x full depth legs. • 800w accessibility sections.
- Complete with kick plate (stainless steel only). • Cable port access between workstations via legs.
- Compatible with DMSF/N/F... and DMSF/F... pedestals only (page 217).
- Connect Rectangular Reception Counter Tops compatible with non-accessibility sections only.

CONR20/ASRH - 2000w x 800d x 740h
CONR18/ASRH - 1800w x 800d x 740h
CONR16/ASRH - 1600w x 800d x 740h

ORANGE - Can be attached to an adjoining workstation, be the end of sequence or be completely freestanding

RED - Must be the end of the sequence



CONR16/ASLH

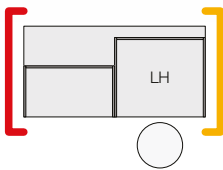

Connect Rectangular Reception Workstation with Accessibility Section

- 2 week lead time. • 25mm top panel. • Compliant with the Equality Act. • Designed for wheelchair visitor access.
- Supplied with 1x AE leg and 2x full depth legs. • 800w accessibility sections.
- Complete with kick plate (stainless steel only). • Cable port access between workstations via legs.
- Compatible with DMSF/N/F... and DMSF/F... pedestals only (page 217).
- Connect Rectangular Reception Counter Tops compatible with non-accessibility sections only.

CONR20/ASLH - 2000w x 800d x 740h
CONR18/ASLH - 1800w x 800d x 740h
CONR16/ASLH - 1600w x 800d x 740h

ORANGE - Can be attached to an adjoining workstation, be the end of sequence or be completely freestanding

RED - Must be the end of the sequence



CONR16/INTASRH

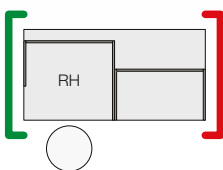

Connect Rectangular Reception Workstation with Inset Leg and Accessibility Section

- **This workstation must be attached to an adjoining workstation on its Left side.**
- 2 week lead time. • 25mm top panel. • Compliant with the Equality Act. • Designed for wheelchair visitor access.
- Supplied with 1x left side inset leg, 1x middle full depth leg and 1x right side AE leg.
- 800w accessibility sections. • Complete with kick plate (stainless steel only).
- Cable port access between workstations via legs.
- Compatible with DMSF/N/F... and DMSF/F... pedestals only (page 217).
- Connect Rectangular Reception Counter Tops compatible with non-accessibility sections only.

CONR20/INTASRH - 2000w x 800d x 740h
CONR18/INTASRH - 1800w x 800d x 740h
CONR16/INTASRH - 1600w x 800d x 740h

GREEN - Must be attached to an adjoining workstation

RED - Must be the end of the sequence

MFC: Available in Ash, Autumn Cherry, Beech, Chester Oak, English Walnut, Grey, Grey Nebraska Oak, Laurentii Wenge, Natural Nebraska Oak and White
Nanotech: Available in Black (2 Week Lead Time)
Edging: Add surcharge for Wenge, Black and Plywood Effect per top - Edging on 25mm White MFC and Black Nanotech only
Metalwork: Silver, Black Graphite and White
 Add surcharge for Praline, Olive Green, Atlantic Blue, Sapphire Blue, Mustard Yellow, Terracotta and Conker Brown (2 Week Lead Time)



CONR16/INTASLH

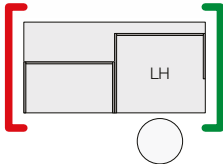

Connect Rectangular Reception Workstation with Inset Leg and Accessibility Section

- This workstation must be attached to an adjoining workstation on its right side.
- 2 week lead time. • 25mm top panel. • Compliant with the Equality Act. • Designed for wheelchair visitor access.
- Supplied with 1x left side AE leg, 1x middle full depth leg and 1x right side inset leg.
- 800w accessibility sections. • Complete with kick plate (stainless steel only).
- Cable port access between workstations via legs.
- Compatible with DMSF/N/F... and DMSF/F... pedestals only (page 217).
- Connect Rectangular Reception Counter Tops compatible with non-accessibility sections only.

- CONR20/INTASLH** - 2000w x 800d x 740h
- CONR18/INTASLH** - 1800w x 800d x 740h
- CONR16/INTASLH** - 1600w x 800d x 740h

GREEN - Must be attached to an adjoining workstation

RED - Must be the end of the sequence



CON/CTR16/38

Connect Rectangular Counter Tops for Rectangular Workstations

- Workstation desktop needs to be removed to attach this product securely.
- 2 week lead time. • 25mm top panel. • Desktops are part drilled to accommodate reception counter tops.
- Compatible with Connect Rectangular Reception Workstations at the same width only.

- CON/CTR20/48** - 2000w x 280d x 480h
- CON/CTR18/48** - 1800w x 280d x 480h
- CON/CTR16/48** - 1600w x 280d x 480h
- CON/CTR14/48** - 1400w x 280d x 480h
- CON/CTR12/48** - 1200w x 280d x 480h
- CON/CTR10/48** - 1000w x 280d x 480h
- CON/CTR8/48** - 800w x 280d x 480h

- CON/CTR20/38** - 2000w x 280d x 380h
- CON/CTR18/38** - 1800w x 280d x 380h
- CON/CTR16/38** - 1600w x 280d x 380h
- CON/CTR14/38** - 1400w x 280d x 380h
- CON/CTR12/38** - 1200w x 280d x 380h
- CON/CTR10/38** - 1000w x 280d x 380h
- CON/CTR8/38** - 800w x 280d x 380h



CON/CTR8/38

Connect Rectangular Counter Tops for Rectangular Workstations with Accessibility Section

- Workstation desktop needs to be removed to attach this product securely.
- 2 week lead time. • 25mm top panel. • Desktops are part drilled to accommodate reception counter tops.
- Compatible on non-accessibility section on Connect Rectangular Reception Workstations with Accessibility Section only.

- CON/CTR12/48** - For 2000w Workstations - 1200w x 280d x 480h
- CON/CTR10/48** - For 1800w Workstations - 1000w x 280d x 480h
- CON/CTR8/48** - For 1600w Workstations - 800w x 280d x 480h

- CON/CTR12/38** - For 2000w Workstations - 1200w x 280d x 380h
- CON/CTR10/38** - For 1800w Workstations - 1000w x 280d x 380h
- CON/CTR8/38** - For 1600w Workstations - 800w x 280d x 380h



OF11
Illustrated in red

Connect Cable Tray

- Standard lead time. • Cable trays are 100mm deep and 110mm high.
- Not compatible with Curved or Corner Workstations.

- OF13** - For 2000w Rectangular Reception Workstations - 1775w
- OF12** - For 1800w Rectangular Reception Workstations - 1675w
- OF11** - For 1600w Rectangular Reception Workstations - 1475w
- OF9** - For 1400w Rectangular Reception Workstations - 1275w
- OF7** - For 1200w Rectangular Reception Workstations - 1075w
- OF5** - For 1000w Rectangular Reception Workstations - 900w
- OF3** - For 800w Rectangular Reception Workstations - 755w

MFC:	Available in Ash, Autumn Cherry, Beech, Chester Oak, English Walnut, Grey, Grey Nebraska Oak, Laurentii Wenge, Natural Nebraska Oak and White
Nanotech:	Available in Black (2 Week Lead Time)
Edging:	Add surcharge for Wenge, Black and Plywood Effect per top - Edging on 25mm White MFC and Black Nanotech only
Metalwork:	Silver, Black Graphite and White
	Add surcharge for Praline, Olive Green, Atlantic Blue, Sapphire Blue, Mustard Yellow, Terracotta and Conker Brown (2 Week Lead Time)



CONCV

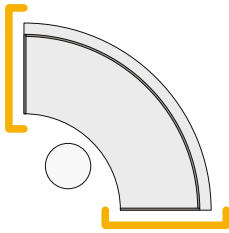

Connect Curved Reception Workstation

- 2 week lead time.
- 25mm top panel.
- Supplied with 2x full depth legs.
- Complete with kick plate (stainless steel only).
- Cable port access between workstations via legs.
- Connect Curved Reception Counter Tops compatible with this product.
- Pedestals not compatible with this product.
- Delivered part assembled.
- Nanotech Curved Workstations will have Nanotech top and sides and require a specified standard MFC finish for the front curved panel.

CONCV - 1650w x 1650d x 740h

ORANGE - Can be attached to an adjoining workstation, be the end of sequence or be completely freestanding



CONCV/AERH

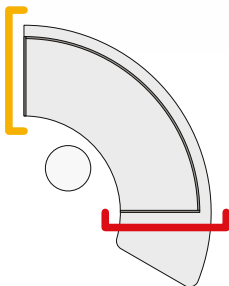

Connect Curved Reception Workstation with Accessibility Extension

- 2 week lead time.
- 25mm top panel.
- Compliant with the Equality Act.
- Designed for wheelchair visitor access.
- Supplied with 2x full depth legs.
- Complete with kick plate (stainless steel only).
- Cable port access between workstations via legs.
- Connect Curved Reception Counter Tops compatible with this product.
- Pedestals not compatible with this product.
- Delivered part assembled.
- Nanotech Curved Workstations will have Nanotech top and sides and require a specified standard MFC finish for the front curved panel.

CONCV/AE... (LH or RH) - 2300w x 1650d x 740h

ORANGE - Can be attached to an adjoining workstation, be the end of sequence or be completely freestanding

RED - Must be the end of the sequence

MFC: Available in Ash, Autumn Cherry, Beech, Chester Oak, English Walnut, Grey, Grey Nebraska Oak, Laurentii Wenge, Natural Nebraska Oak and White
Nanotech: Available in Black (2 Week Lead Time)
Edging: Add surcharge for Wenge, Black and Plywood Effect per top - Edging on 25mm White MFC and Black Nanotech only
Metalwork: Silver, Black Graphite and White
 Add surcharge for Praline, Olive Green, Atlantic Blue, Sapphire Blue, Mustard Yellow, Terracotta and Conker Brown (2 Week Lead Time)



CONCN/INT

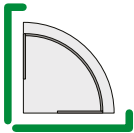

Connect Corner Reception Workstation with Double Inset Legs

- This workstation must be attached to an adjoining workstation on both sides.
- 2 week lead time. • 25mm top panel. • Supplied with 2x inset legs. • Complete with kick plate (stainless steel only).
- Cable port access between workstations via legs. • Delivered assembled.
- Nanotech Curved Workstations will have Nanotech top and sides and require a specified standard MFC finish for the front curved panel.

CONCN/INT - 800w x 800d x 740h

GREEN - Must be attached to an adjoining workstation



CONCN/INTRH

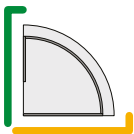

Connect Corner Reception Workstation with Inset Leg

- This workstation must be attached to an adjoining workstation on its left side.
- 2 week lead time. • 25mm top panel. • Supplied with 1x left side inset leg and 1x right side full depth leg.
- Complete with kick plate (stainless steel only). • Cable port access between workstations via legs.
- Delivered assembled.
- Nanotech Curved Workstations will have Nanotech top and sides and require a specified standard MFC finish for the front curved panel.

CONCN/INTRH - 800w x 800d x 740h

GREEN - Must be attached to an adjoining workstation

ORANGE - Can be attached to an adjoining workstation or be the end of sequence



CONCN/INTLH

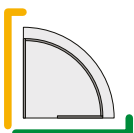

Connect Corner Reception Workstation with Inset Leg

- This workstation must be attached to an adjoining workstation on its right side.
- 2 week lead time. • 25mm top panel. • Supplied with 1x left side full depth leg and 1x right side inset leg.
- Complete with kick plate (stainless steel only). • Cable port access between workstations via legs.
- Delivered assembled.
- Nanotech Curved Workstations will have Nanotech top and sides and require a specified standard MFC finish for the front curved panel.

CONCN/INTLH - 800w x 800d x 740h

GREEN - Must be attached to an adjoining workstation

ORANGE - Can be attached to an adjoining workstation or be the end of sequence

MFC: Available in Ash, Autumn Cherry, Beech, Chester Oak, English Walnut, Grey, Grey Nebraska Oak, Laurentii Wenge, Natural Nebraska Oak and White
Nanotech: Available in Black (2 Week Lead Time)
Edging: Add surcharge for Wenge, Black and Plywood Effect per top - Edging on 25mm White MFC and Black Nanotech only
Metalwork: Silver, Black Graphite and White
 Add surcharge for Praline, Olive Green, Atlantic Blue, Sapphire Blue, Mustard Yellow, Terracotta and Conker Brown (2 Week Lead Time)



CON/CTCV/F38

Connect Curved Reception Counter Tops

- Workstation desktop needs to be removed to attach this product securely.
- 2 week lead time. • 25mm top panel. • Desktops are part drilled to accommodate reception counter tops.
- Compatible with Connect Curved Reception Workstations.
- Nanotech Curved Workstations will have Nanotech top and sides and require a specified standard MFC finish for the front curved panel.

CON/CTCV/F48 - 2335w (extreme) x 280d x 480h

CON/CTCV/F38 - 2335w (extreme) x 280d x 380h



CON/CTCV/T38

Connect Curved Reception Third Counter Tops

- Workstation desktop needs to be removed to attach this product securely.
- 2 week lead time. • 25mm top panel. • Desktops are part drilled to accommodate reception counter tops.
- Compatible with Connect Curved Reception Workstations.
- Nanotech Curved Workstations will have Nanotech top and sides and require a specified standard MFC finish for the front curved panel.

CON/CTCV/T48 - 850w (extreme) x 280d x 480h

CON/CTCV/T38 - 850w (extreme) x 280d x 380h



CON/CTCN/T38

Connect Corner Reception Counter Tops

- Workstation desktop needs to be removed to attach this product securely.
- 2 week lead time. • 25mm top panel. • Desktops are part drilled to accommodate reception counter tops.
- Compatible with Connect Corner Reception Workstations.
- Nanotech Curved Workstations will have Nanotech top and sides and require a specified standard MFC finish for the front curved panel.

CON/CTCN/48 - 1140w x 280d x 480h

CON/CTCN/38 - 1140w x 280d x 380h

Reception

Windsor

MFC:	Available in Ash, Autumn Cherry, Beech, Chester Oak, English Walnut, Grey, Grey Nebraska Oak, Laurentii Wenge, Natural Nebraska Oak and White
Veneer:	Available in Oak and Walnut (<i>3 Week Lead Time</i>)
Edging:	Add surcharge for Wenge, Black and Plywood Effect per top - <i>Edging on 25mm White MFC only</i>
Metalwork:	Silver, Black Graphite and White



WRU18RH

Windsor Bow Fronted Reception Workstation

- Standard lead times.
- 25mm top panel.
- 600mm return.
- Desktop is 745mm high.

WRU20... (LH or RH) - 2000w x 1350d x 1100h

WRU18... (LH or RH) - 1800w x 1350d x 1100h



RRRH

Windsor Radius Reception Desk with DDA Extension

- Standard lead times.
- 25mm top panel.
- Designed for wheelchair visitor access.
- Complete with kick plate (stainless steel only).
- Delivered assembled.
- Desktop is 745mm high.

RR... (LH or RH) - 2800w (extreme) x 800d x 745h



RR

Windsor Radius Reception Desk

- Standard lead times.
- 25mm top panel.
- Complete with kick plate (stainless steel only).
- Delivered assembled.
- Desktop is 745mm high.

RR - 1915w (extreme) x 800d x 745h



DCT

Windsor Curved Double Counter Top

- Standard lead times.
- 25mm top panel.
- Windsor curved double counter top does not sit flush either end of Windsor radius reception desks due to its fixings.

DCT - 1800w (extreme) x 240d x 380h



SCT

Windsor Curved Single Counter Top

- Standard lead times.
- 25mm top panel.
- Windsor curved single counter top can be positioned left, centre or right of the reception desk.

SCT - 980w x 240d x 380h

Reception

Accessories and Compatibility Breakdown

MFC: Available in Ash, Autumn Cherry, Beech, Chester Oak, English Walnut, Grey, Grey Nebraska Oak, Laurentii Wenge, Natural Nebraska Oak and White
Veneer: Available in Oak and Walnut (*3 Week Lead Time*)
Edging: Add surcharge for Wenge, Black and Plywood Effect per top - *Edging on 25mm White MFC only*
Metalwork: Silver, Black Graphite and White



RS12

Oval Reception Shelf

- Standard lead times. • 25mm top panel.

RS14 - 1400w x 300d x 225h

RS12 - 1200w x 300d x 225h

RS10 - 1000w x 300d x 225h



RSG12

Oval Reception Shelf

- Standard lead times. • 10mm toughened clear glass.

RSG14 - 1400w x 300d x 215h

RSG12 - 1200w x 300d x 215h

RSG10 - 1000w x 300d x 215h



RSRH

'L' Shaped Reception Shelf

- Standard lead times. • 25mm top panel.
- Compatible with Kassini, Optima Plus and Callisto Reception Desks.

RS... (LH or RH) - 1850w x 1650d x 225h



RSGRH

'L' Shaped Reception Shelf

- Standard lead times. • 10mm toughened clear glass.
- Compatible with Kassini, Optima Plus and Callisto Reception Desks.

RSG... (LH or RH) - 1850w x 1650d x 215h

Reception Compatibility Breakdown

- **Black** - Compatible
- **Orange** - Non-standard position required
- **Green** - Unspecified

Reception - Connect

Reception - Windsor Bow Fronted Reception

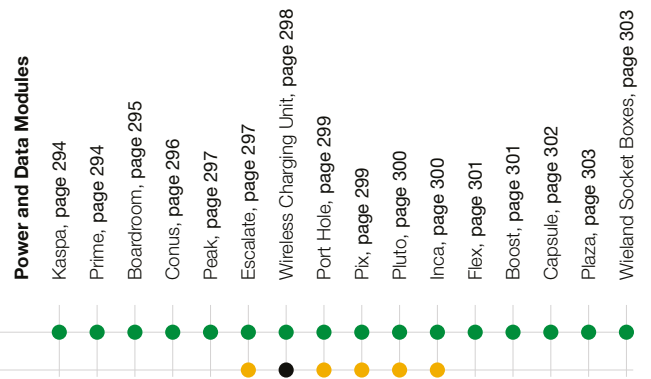

Conference / Meeting Tables

Various Conference / Meeting Ranges, Storage and Accessories



Taking inspiration from our core desking ranges, the Conference / Meeting portfolio delivers solutions and options that offer full flexibility, modern finishes and budgets to suit. Each table within the collection can be specified with wire management options and surface mounted power, data, and USB charging modules.

The introduction of timber framework into the portfolio with Lux Boardroom tables provides clients with a contemporary option to complement their workspace and make a lasting impression. The elegant Progress Plus Sit-Stand conference room table available in two configurations, with height adjustment of 650mm to 1280mm by use of a surface mounted touchpad, capable of accommodating up to 10 or 14 people.



Conference / Meeting

Progress Plus Height Adjustable Conference Tables

3 Week Lead Time

MFC: Available in Ash, Autumn Cherry, Beech, Chester Oak, English Walnut, Grey, Grey Nebraska Oak, Laurentii Wenge, Natural Nebraska Oak and White
Nanotech: Available in Black (2 Week Lead Time)
Edging: Add surcharge for Wenge, Black and Plywood Effect per top - Edging on 25mm White MFC and Black Nanotech only
Metalwork: Silver, Black Graphite and White

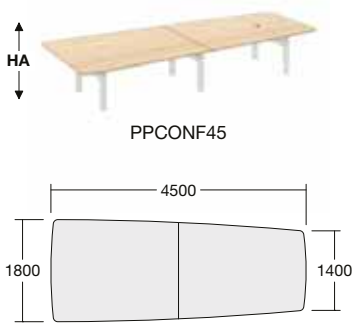

Progress Plus Electric Height Adjustable Half-Barrel Conference Table

- 3 week lead time.
- 2x 25mm top panels.
- Complete with horizontal cable trays.
- Sit / stand height adjustment of 650mm-1280mm via electronic up / down keypad situated on the desktop.
- Anti-collision as standard.

PPCONF45 - 4500w x 1800/1400d x 650-1280h
2x 2250mm Sections - Seating up to 14 People

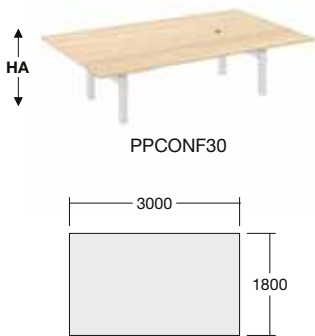

Progress Plus Electric Height Adjustable Rectangular Conference Table

- 3 week lead time.
- 1x 25mm top panels.
- Complete with horizontal cable trays.
- Sit / stand height adjustment of 650mm-1280mm via electronic up / down keypad situated on the desktop.
- Anti-collision as standard.

PPCONF30 - 3000w x 1800d x 650-1280h
1x 3000mm Sections - Seating up to 10 People



Conference / Meeting

Aerofoil Fixed Height Conference Tables

MFC: Available in Ash, Autumn Cherry, Beech, Chester Oak, English Walnut, Grey, Grey Nebraska Oak, Laurentii Wenge, Natural Nebraska Oak and White
Nanotech: Available in Black (2 Week Lead Time) - Nanotech on 25mm Desktops only
Veneer: Available in Oak and Walnut (3 Week Lead Time)
Edging: Add surcharge for Wenge, Black and Plywood Effect per top - Edging on 25mm White MFC and Black Nanotech only
Metalwork: Silver, Black Graphite and White
Add surcharge for Praline, Olive Green, Atlantic Blue, Sapphire Blue, Mustard Yellow, Terracotta and Conker Brown (2 Week Lead Time)



ABT32

Aerofoil Boardroom Table

- Standard lead times.
- 2x 25mm top panels.
- Horizontal and vertical cable management.
- Barrel shaped top with elliptical base and silver extruded uprights.

ABT40 - 4000w x 1300d x 740h
2x 2000mm Sections - Seating up to 14 People

ABT38 - 3800w x 1300d x 740h
2x 1900mm Sections - Seating up to 12 People

ABT36 - 3600w x 1300d x 740h
2x 1800mm Sections - Seating up to 12 People

ABT34 - 3400w x 1300d x 740h
2x 1700mm Sections - Seating up to 10 People

ABT32 - 3200w x 1300d x 740h
2x 1600mm Sections - Seating up to 10 People



ABT26

Aerofoil Boardroom Table

- Standard lead times.
- 25mm top panel.
- Horizontal and vertical cable management.
- Barrel shaped top with elliptical base and silver extruded uprights.

ABT30 - 3000w x 1300d x 740h
1x 3000mm Section - Seating up to 10 People

ABT28 - 2800w x 1300d x 740h
1x 2800mm Section - Seating up to 8 People

ABT26 - 2600w x 1300d x 740h
1x 2600mm Section - Seating up to 8 People

Conference / Meeting

Lux Conference and Meeting Tables

2 Week Lead Time

MFC:	Available in Ash, Autumn Cherry, Beech, Chester Oak, English Walnut, Grey, Grey Nebraska Oak, Laurentii Wenge, Natural Nebraska Oak and White
Nanotech:	Available in Black (2 Week Lead Time)
Veneer:	Available in Oak and Walnut (3 Week Lead Time)
Edging:	Add surcharge for Wenge, Black and Plywood Effect per top - Edging on 25mm White MFC and Black Nanotech only
Metalwork:	Silver, Black Graphite and White
Additional:	Standard corners (no suffix) - Add surcharge for radiused corners (suffix .../RC (page 46))



LUXOCT2800/ASL

Lux Octagonal Conference Table

- 2 week lead time.
- 25mm top panel.
- Tapered legs with adjustable levelling feet and steel sub-frame.

LUXOCT2800... - 2800w x 1200d x 740h
1x 2800mm Section - Seating up to 10 People

LUXOCT2600... - 2600w x 1200d x 740h
1x 2600mm Section - Seating up to 8 People

LUXOCT2400... - 2400w x 1000d x 740h
1x 2400mm Section - Seating up to 8 People

Finishes: Ash (.../ASL) Legs
Add surcharge for Stained Walnut (.../WAL), Stained Espresso (.../ESL), Stained Wenge (.../WEL), Stained Grey (.../GYL), Stained Black (.../BKL) and White (.../WHL) Legs



LUXMT32/12/ASL

Lux Rectangular Meeting Table

- 2 week lead time.
- 2x 25mm top panels.
- Tapered legs with adjustable levelling feet and steel sub-frame.
- Available with radiused corners (see 'Additional' above).

LUXMT48/16... - 2x Sections - 4800w x 1600d x 740h
LUXMT44/16... - 2x Sections - 4400w x 1600d x 740h
LUXMT40/16... - 2x Sections - 4000w x 1600d x 740h
LUXMT36/16... - 2x Sections - 3600w x 1600d x 740h
LUXMT32/16... - 2x Sections - 3200w x 1600d x 740h
LUXMT30/16... - 2x Sections - 3000w x 1600d x 740h

LUXMT48/14... - 2x Sections - 4800w x 1400d x 740h
LUXMT44/14... - 2x Sections - 4400w x 1400d x 740h
LUXMT40/14... - 2x Sections - 4000w x 1400d x 740h
LUXMT36/14... - 2x Sections - 3600w x 1400d x 740h
LUXMT32/14... - 2x Sections - 3200w x 1400d x 740h
LUXMT30/14... - 2x Sections - 3000w x 1400d x 740h

LUXMT48/12... - 2x Sections - 4800w x 1200d x 740h
LUXMT44/12... - 2x Sections - 4400w x 1200d x 740h
LUXMT40/12... - 2x Sections - 4000w x 1200d x 740h
LUXMT36/12... - 2x Sections - 3600w x 1200d x 740h
LUXMT32/12... - 2x Sections - 3200w x 1200d x 740h
LUXMT30/12... - 2x Sections - 3000w x 1200d x 740h

LUXMT48/10... - 2x Sections - 4800w x 1000d x 740h
LUXMT44/10... - 2x Sections - 4400w x 1000d x 740h
LUXMT40/10... - 2x Sections - 4000w x 1000d x 740h
LUXMT36/10... - 2x Sections - 3600w x 1000d x 740h
LUXMT32/10... - 2x Sections - 3200w x 1000d x 740h
LUXMT30/10... - 2x Sections - 3000w x 1000d x 740h

Finishes: Ash (.../ASL) Legs
Add surcharge for Stained Walnut (.../WAL), Stained Espresso (.../ESL), Stained Wenge (.../WEL), Stained Grey (.../GYL), Stained Black (.../BKL) and White (.../WHL) Legs

Conference / Meeting

Lux Meeting Tables

2 Week Lead Time

MFC:	Available in Ash, Autumn Cherry, Beech, Chester Oak, English Walnut, Grey, Grey Nebraska Oak, Laurentii Wenge, Natural Nebraska Oak and White
Nanotech:	Available in Black (2 Week Lead Time)
Veneer:	Available in Oak and Walnut (3 Week Lead Time)
Edging:	Add surcharge for Wenge, Black and Plywood Effect per top - Edging on 25mm White MFC and Black Nanotech only
Metalwork:	Silver, Black Graphite and White
Additional:	Standard corners (no suffix) - Add surcharge for radiused corners (suffix .../RC (page 46))



LUXMT16/12/ASL

Lux Rectangular Meeting Table

- 2 week lead time. • 25mm top panel.
- Tapered legs with adjustable levelling feet and steel sub-frame.
- Available with radiused corners (see 'Additional' above).

LUXMT28/16...	- 1x Section - 2800w x 1600d x 740h
LUXMT26/16...	- 1x Section - 2600w x 1600d x 740h
LUXMT24/16...	- 1x Section - 2400w x 1600d x 740h
LUXMT22/16...	- 1x Section - 2200w x 1600d x 740h
LUXMT20/16...	- 1x Section - 2000w x 1600d x 740h
LUXMT18/16...	- 1x Section - 1800w x 1600d x 740h

LUXMT28/14...	- 1x Section - 2800w x 1400d x 740h
LUXMT26/14...	- 1x Section - 2600w x 1400d x 740h
LUXMT24/14...	- 1x Section - 2400w x 1400d x 740h
LUXMT22/14...	- 1x Section - 2200w x 1400d x 740h
LUXMT20/14...	- 1x Section - 2000w x 1400d x 740h
LUXMT18/14...	- 1x Section - 1800w x 1400d x 740h
LUXMT16/14...	- 1x Section - 1600w x 1400d x 740h

LUXMT28/12...	- 1x Section - 2800w x 1200d x 740h
LUXMT26/12...	- 1x Section - 2600w x 1200d x 740h
LUXMT24/12...	- 1x Section - 2400w x 1200d x 740h
LUXMT22/12...	- 1x Section - 2200w x 1200d x 740h
LUXMT20/12...	- 1x Section - 2000w x 1200d x 740h
LUXMT18/12...	- 1x Section - 1800w x 1200d x 740h
LUXMT16/12...	- 1x Section - 1600w x 1200d x 740h
LUXMT14/12...	- 1x Section - 1400w x 1200d x 740h

LUXMT28/10...	- 1x Section - 2800w x 1000d x 740h
LUXMT26/10...	- 1x Section - 2600w x 1000d x 740h
LUXMT24/10...	- 1x Section - 2400w x 1000d x 740h
LUXMT22/10...	- 1x Section - 2200w x 1000d x 740h
LUXMT20/10...	- 1x Section - 2000w x 1000d x 740h
LUXMT18/10...	- 1x Section - 1800w x 1000d x 740h
LUXMT16/10...	- 1x Section - 1600w x 1000d x 740h
LUXMT14/10...	- 1x Section - 1400w x 1000d x 740h
LUXMT12/10...	- 1x Section - 1200w x 1000d x 740h

Finishes: Ash (.../ASL) Legs
Add surcharge for Stained Walnut (.../WAL), Stained Espresso (.../ESL), Stained Wenge (.../WEL), Stained Grey (.../GYL), Stained Black (.../BKL) and White (.../WHL) Legs



LUXMT16/16/ASL

Lux Square Meeting Table

- 2 week lead time. • 25mm top panel.
- Tapered legs with adjustable levelling feet and steel sub-frame.
- Available with radiused corners (see 'Additional' above).

LUXMT20/20...	- 2000w x 2000d x 740h
LUXMT18/18...	- 1800w x 1800d x 740h
LUXMT16/16...	- 1600w x 1600d x 740h
LUXMT14/14...	- 1400w x 1400d x 740h
LUXMT12/12...	- 1200w x 1200d x 740h
LUXMT10/10...	- 1000w x 1000d x 740h

Finishes: Ash (.../ASL) Legs
Add surcharge for Stained Walnut (.../WAL), Stained Espresso (.../ESL), Stained Wenge (.../WEL), Stained Grey (.../GYL), Stained Black (.../BKL) and White (.../WHL) Legs

Conference / Meeting

Lux Meeting Tables

2 Week Lead Time

MFC:	Available in Ash, Autumn Cherry, Beech, Chester Oak, English Walnut, Grey, Grey Nebraska Oak, Laurentii Wenge, Natural Nebraska Oak and White
Nanotech:	Available in Black (2 Week Lead Time)
Veneer:	Available in Oak and Walnut (3 Week Lead Time)
Edging:	Add surcharge for Wenge, Black and Plywood Effect per top - Edging on 25mm White MFC and Black Nanotech only
Metalwork:	Silver, Black Graphite and White



LUXMT/CIR16/ASL

Lux Circular Meeting Table

- 2 week lead time.
- 25mm top panel.
- Tapered legs with adjustable levelling feet and steel sub-frame.

LUXMT/CIR20...	- 2000w (dia) x 740h
LUXMT/CIR18...	- 1800w (dia) x 740h
LUXMT/CIR16...	- 1600w (dia) x 740h
LUXMT/CIR14...	- 1400w (dia) x 740h
LUXMT/CIR12...	- 1200w (dia) x 740h
LUXMT/CIR10...	- 1000w (dia) x 740h

Finishes:

Ash (.../ASL) Legs

Add surcharge for Stained Walnut (.../WAL), Stained Espresso (.../ESL), Stained Wenge (.../WEL), Stained Grey (.../GYL), Stained Black (.../BKL) and White (.../WHL) Legs



LUXB16/16/ASL/RC

Lux Optional Radiused Corners

- 2 week lead time.
- Adds a radius to 4 corners of specific Lux workstations.
- Suffix .../RC to the end of relevant Lux codes.

.../RC - Radiused Corners



Conference / Meeting

Reflex Conference and Meeting Tables

2 Week Lead Time

MFC: Available in Ash, Autumn Cherry, Beech, Chester Oak, English Walnut, Grey, Grey Nebraska Oak, Laurentii Wenge, Natural Nebraska Oak and White
Nanotech: Available in Black (2 Week Lead Time)
Veneer: Available in Oak and Walnut (3 Week Lead Time)
Edging: Add surcharge for Wenge, Black and Plywood Effect per top - Edging on 25mm White MFC and Black Nanotech only
Metalwork: Silver, Black Graphite and White - Add surcharge for Chrome Effect and Raw
Add surcharge for Praline, Olive Green, Atlantic Blue, Sapphire Blue, Mustard Yellow, Terracotta and Conker Brown



ROCT3000

Reflex Octagonal Conference Table

- 2 week lead time.
- 25mm top panel.
- Shared centre legs.
- Tapered angled legs with steel sub-frame.
- Adjustable levelling feet.

ROCT3000 - 3000w x 1400d x 740h
1x 3000mm Section - Seating up to 10 People



ROCT2800

Reflex Octagonal Conference Table

- 2 week lead time.
- 25mm top panel.
- Tapered angled legs with steel sub-frame.
- Adjustable levelling feet.

ROCT2800 - 2800w x 1200d x 740h
1x 2800mm Section - Seating up to 10 People

ROCT2600 - 2600w x 1200d x 740h
1x 2600mm Section - Seating up to 8 People

ROCT2400 - 2400w x 1000d x 740h
1x 2400mm Section - Seating up to 8 People



RMT32/12

Reflex Rectangular Meeting Table

- 2 week lead time.
- 2x 25mm top panels.
- Shared centre legs.
- Tapered angled legs with steel sub-frame.
- Adjustable levelling feet.

RMT48/14 - 2x Sections - 4800w x 1400d x 740h
RMT44/14 - 2x Sections - 4400w x 1400d x 740h
RMT40/14 - 2x Sections - 4000w x 1400d x 740h
RMT36/14 - 2x Sections - 3600w x 1400d x 740h
RMT32/14 - 2x Sections - 3200w x 1400d x 740h
RMT30/14 - 2x Sections - 3000w x 1400d x 740h

RMT48/12 - 2x Sections - 4800w x 1200d x 740h
RMT44/12 - 2x Sections - 4400w x 1200d x 740h
RMT40/12 - 2x Sections - 4000w x 1200d x 740h
RMT36/12 - 2x Sections - 3600w x 1200d x 740h
RMT32/12 - 2x Sections - 3200w x 1200d x 740h
RMT30/12 - 2x Sections - 3000w x 1200d x 740h

RMT48/10 - 2x Sections - 4800w x 1000d x 740h
RMT44/10 - 2x Sections - 4400w x 1000d x 740h
RMT40/10 - 2x Sections - 4000w x 1000d x 740h
RMT36/10 - 2x Sections - 3600w x 1000d x 740h
RMT32/10 - 2x Sections - 3200w x 1000d x 740h
RMT30/10 - 2x Sections - 3000w x 1000d x 740h



Conference / Meeting

Reflex Meeting Tables

2 Week Lead Time

MFC: Available in Ash, Autumn Cherry, Beech, Chester Oak, English Walnut, Grey, Grey Nebraska Oak, Laurentii Wenge, Natural Nebraska Oak and White
Nanotech: Available in Black (2 Week Lead Time)
Veneer: Available in Oak and Walnut (3 Week Lead Time)
Edging: Add surcharge for Wenge, Black and Plywood Effect per top - Edging on 25mm White MFC and Black Nanotech only
Metalwork: Silver, Black Graphite and White - Add surcharge for Chrome Effect and Raw
Add surcharge for Praline, Olive Green, Atlantic Blue, Sapphire Blue, Mustard Yellow, Terracotta and Conker Brown



RMT16/12

Reflex Rectangular Meeting Table

- 2 week lead time.
- 25mm top panel.
- Tapered angled legs with steel sub-frame.
- Adjustable levelling feet.

RMT28/14 - 1x Section - 2800w x 1400d x 740h
RMT26/14 - 1x Section - 2600w x 1400d x 740h
RMT24/14 - 1x Section - 2400w x 1400d x 740h
RMT22/14 - 1x Section - 2200w x 1400d x 740h
RMT20/14 - 1x Section - 2000w x 1400d x 740h
RMT18/14 - 1x Section - 1800w x 1400d x 740h
RMT16/14 - 1x Section - 1600w x 1400d x 740h

RMT28/12 - 1x Section - 2800w x 1200d x 740h
RMT26/12 - 1x Section - 2600w x 1200d x 740h
RMT24/12 - 1x Section - 2400w x 1200d x 740h
RMT22/12 - 1x Section - 2200w x 1200d x 740h
RMT20/12 - 1x Section - 2000w x 1200d x 740h
RMT18/12 - 1x Section - 1800w x 1200d x 740h
RMT16/12 - 1x Section - 1600w x 1200d x 740h
RMT14/12 - 1x Section - 1400w x 1200d x 740h

RMT28/10 - 1x Section - 2800w x 1000d x 740h
RMT26/10 - 1x Section - 2600w x 1000d x 740h
RMT24/10 - 1x Section - 2400w x 1000d x 740h
RMT22/10 - 1x Section - 2200w x 1000d x 740h
RMT20/10 - 1x Section - 2000w x 1000d x 740h
RMT18/10 - 1x Section - 1800w x 1000d x 740h
RMT16/10 - 1x Section - 1600w x 1000d x 740h
RMT14/10 - 1x Section - 1400w x 1000d x 740h
RMT12/10 - 1x Section - 1200w x 1000d x 740h



RMT16/16

Reflex Square Meeting Table

- 2 week lead time.
- 25mm top panel.
- Tapered angled legs with steel sub-frame.
- Adjustable levelling feet.

RMT20/20 - 2000w x 2000d x 740h
RMT18/18 - 1800w x 1800d x 740h
RMT16/16 - 1600w x 1600d x 740h
RMT14/14 - 1400w x 1400d x 740h
RMT12/12 - 1200w x 1200d x 740h
RMT10/10 - 1000w x 1000d x 740h



RMT/CIR16

Reflex Circular Meeting Table

- 2 week lead time.
- 25mm top panel.
- Tapered angled legs with steel sub-frame.
- Adjustable levelling feet.

RMT/CIR20 - 2000w (dia) x 740h
RMT/CIR18 - 1800w (dia) x 740h
RMT/CIR16 - 1600w (dia) x 740h
RMT/CIR14 - 1400w (dia) x 740h
RMT/CIR12 - 1200w (dia) x 740h
RMT/CIR10 - 1000w (dia) x 740h

Conference / Meeting

Reflex and Lux Accessories

2 Week Lead Time

Metalwork: Silver, Black Graphite and White - Add surcharge for Chrome Effect and Raw
Add surcharge for Praline, Olive Green, Atlantic Blue, Sapphire Blue, Mustard Yellow, Terracotta and Conker Brown



LCTR16
Illustrated in red



LCTR16
Illustrated in red

Lux and Reflex Meeting Cable Tray

- 2 week lead time. • Compatible with all Lux and Reflex conference / meeting tables.
- High capacity cable management system neatly conceals power, data and telecom cables through a hinged cable management tray. • Cable trays are 230mm deep and 80mm high.

LCTO30	- For ROCT3000	- 1200w (2x)
LCTO28	- For LUXOCT2800 and ROCT2800	- 1100w (2x)
LCTO26	- For LUXOCT2600 and ROCT2600	- 1000w (2x)
LCTO24	- For LUXOCT2400 and ROCT2400	- 900w (2x)
LCTR48	- For 4800w Rectangular Meeting	- 900w (4x)
LCTR44	- For 4400w Rectangular Meeting	- 800w (4x)
LCTR40	- For 4000w Rectangular Meeting	- 1500w (2x)
LCTR36	- For 3600w Rectangular Meeting	- 1300w (2x)
LCTR32	- For 3200w Rectangular Meeting	- 1100w (2x)
LCTR30	- For 3000w Rectangular Meeting	- 1000w (2x)
LCTR28	- For 2800w Rectangular Meeting	- 1100w (2x)
LCTR26	- For 2600w Rectangular Meeting	- 1000w (2x)
LCTR24	- For 2400w Rectangular Meeting	- 900w (2x)
LCTR22	- For 2200w Rectangular Meeting	- 800w (2x)
LCTR20	- For 2000w Rectangular Meeting	- 1500w
LCTR18	- For 1800w Rectangular Meeting	- 1300w
LCTR16	- For 1600w Rectangular Meeting	- 1100w
LCTR14	- For 1400w Rectangular Meeting	- 900w
LCTR12	- For 1200w Rectangular Meeting	- 700w
LCTS20	- For 2000w Square Meeting	- 1500w
LCTS18	- For 1800w Square Meeting	- 1300w
LCTS16	- For 1600w Square Meeting	- 1100w
LCTS14	- For 1400w Square Meeting	- 900w
LCTS12	- For 1200w Square Meeting	- 700w
LCTS10	- For 1000w Square Meeting	- 500w
LCTC18	- For 2000w and 1800w Circular Meeting	- 900w
LCTC16	- For 1600w Circular Meeting	- 700w
LCTC14	- For 1400w Circular Meeting	- 600w
LCTC12	- For 1200w Circular Meeting	- 500w



Conference / Meeting

Qube Fixed Height Meeting Tables

MFC:	Available in Ash, Autumn Cherry, Beech, Chester Oak, English Walnut, Grey, Grey Nebraska Oak, Laurentii Wenge, Natural Nebraska Oak and White
Nanotech:	Available in Black (2 Week Lead Time)
Veneer:	Available in Oak and Walnut (3 Week Lead Time)
Edging:	Add surcharge for Wenge, Black and Plywood Effect per top - Edging on 25mm White MFC and Black Nanotech only
Metalwork:	Silver, Black Graphite and White



QUBR32/16

Qube Rectangular Meeting Table with Double Square Base

- Standard lead times. • 2x 25mm top panels and 2x bases. • Metal corner upright.
- Column base finished in the same MFC as specified for table top.
- Wire managed base, 2x 80mm apertures, located within the column.

QUBR32/16 - 3200w x 1600d x 740h

QUBR32/14 - 3200w x 1400d x 740h



QUBR32/12

Qube Rectangular Meeting Table with Triple Square Base

- Standard lead times. • 2x 25mm top panels and 3x bases. • Metal corner upright.
- Column base finished in the same MFC as specified for table top.
- Wire managed base, 3x 80mm apertures, located within the column.

QUBR32/12 - 3200w x 1200d x 740h

QUBR32/10 - 3200w x 1000d x 740h



QUBR28/12

Qube Rectangular Meeting Table with Double Square Base

- Standard lead times. • 25mm top panel. • Metal corner upright.
- Column base finished in the same MFC as specified for table top.
- Wire managed base, 2x 80mm apertures, located within the column.

QUBR28/16 - 2800w x 1600d x 740h

QUBR24/16 - 2400w x 1600d x 740h

QUBR28/14 - 2800w x 1400d x 740h

QUBR24/14 - 2400w x 1400d x 740h

QUBR28/12 - 2800w x 1200d x 740h

QUBR24/12 - 2400w x 1200d x 740h

QUBR28/10 - 2800w x 1000d x 740h

QUBR24/10 - 2400w x 1000d x 740h



QUBR20/12

Qube Rectangular Meeting Table

- Standard lead times. • 25mm top panel. • Metal corner upright.
- Column base finished in the same MFC as specified for table top.
- Wire managed base, 80mm aperture, located within the column.

QUBR20/16 - 2000w x 1600d x 740h

QUBR20/14 - 2000w x 1400d x 740h

QUBR20/12 - 2000w x 1200d x 740h

QUBR20/10 - 2000w x 1000d x 740h



QUBS12/12

Qube Square Meeting Table

- Standard lead times. • 25mm top panel. • Metal corner upright.
- Column base finished in the same MFC as specified for table top.
- Wire managed base, 80mm aperture, located within the column.

QUBS16/16 - 1600w x 1600d x 740h

QUBS14/14 - 1400w x 1400d x 740h

QUBS12/12 - 1200w x 1200d x 740h

QUBS10/10 - 1000w x 1000d x 740h

Conference / Meeting

Progress Conference and Meeting Tables and Accessories

6 Week Lead Time

MFC: Available in Ash, Autumn Cherry, Beech, Chester Oak, English Walnut, Grey, Grey Nebraska Oak, Laurentii Wenge, Natural Nebraska Oak and White
Nanotech: Available in Black (2 Week Lead Time)
Veneer: Available in Oak and Walnut (3 Week Lead Time)
Edging: Add surcharge for Wenge, Black and Plywood Effect per top - Edging on 25mm White MFC and Black Nanotech only
Metalwork: Silver and White



PCONF2

Progress Fixed Height Rectangular Conference Table

- 6 week lead time. • 2x 25mm top panels.

PCONF2 - 3400w x 1200d x 740h
2x 1700mm Sections - Seating up to 10 People



PCONF1A

Progress Fixed Height Rectangular Conference Table

- 6 week lead time. • 25mm top panel.

PCONF1B - 2400w x 1200d x 740h
1x 2400mm Sections - Seating up to 8 People

PCONF1A - 2000w x 1200d x 740h
1x 2000mm Sections - Seating up to 8 People



PRMT20/10

Progress Fixed Height Rectangular Meeting Table

- 6 week lead time. • 25mm top panel.

PRMT22/10 - 2200w x 1000d x 740h
PRMT20/10 - 2000w x 1000d x 740h

PRMT20/8 - 2000w x 800d x 740h



PRCT20
Illustrated in red

Progress Meeting Cable Tray

- Standard lead time. • Compatible with Progress conference and meeting tables only.
- Meeting cable trays are 100mm deep and 110mm high.

PRCT34 - For PCONF2 - Sold in 2x Sections - 2x 900w
PRCT24 - For PCONF1B - 1300w
PRCT22 - For 2200w Meeting Tables - 1100w
PRCT20 - For PCONF1A and 2000w Meeting Tables - 900w

Conference / Meeting

Linnea Fixed Height Conference and Meeting Tables

- MFC:** Available in Ash, Autumn Cherry, Beech, Chester Oak, English Walnut, Grey, Grey Nebraska Oak, Laurentii Wenge, Natural Nebraska Oak and White
Nanotech: Available in Black (2 Week Lead Time)
Veneer: Available in Oak and Walnut (3 Week Lead Time)
Edging: Add surcharge for Wenge, Black and Plywood Effect per top - Edging on 25mm White MFC and Black Nanotech only
Metalwork: Silver, Black Graphite and White - Add surcharge for Chrome Effect and Raw
 Add surcharge for Praline, Olive Green, Atlantic Blue, Sapphire Blue, Mustard Yellow, Terracotta and Conker Brown (2 Week Lead Time)
- Additional:** Standard legs (no suffix) - 90 degree legs (suffix .../90 (page 62))



LCONF48

Linnea Double 'D' Ended Conference Table

- Standard lead times. • 25mm top panel.
- Available with 90 degree Linnea leg (see 'Additional' above).

LCONF48 - 4800w x 1200d x 740h
 2x 1700mm and 1x 1400mm Sections - Seating up to 16 People



LCONF34

Linnea Double 'D' Ended Conference Table

- Standard lead times. • 25mm top panel.
- Available with 90 degree Linnea leg (see 'Additional' above).

LCONF44 - 4400w x 1200d x 740h
 2x 2200mm Sections - Seating up to 14 People

LCONF34 - 3400w x 1200d x 740h
 2x 1700mm Sections - Seating up to 10 People



LCONF24

Linnea Double 'D' Ended Conference Table

- Standard lead times. • 25mm top panel.
- Available with 90 degree Linnea leg (see 'Additional' above).

LCONF24 - 2400w x 1200d x 740h
 1x 2400mm Section - Seating up to 8 People

LCONF20 - 2000w x 1200d x 740h
 1x 2000mm Section - Seating up to 6 People



LMT16/12

Linnea Meeting Table

- Standard lead times. • 25mm top panel.
- Available with 90 degree Linnea leg (see 'Additional' above).

LMT22/16 - 2200w x 1600d x 740h
LMT20/16 - 2000w x 1600d x 740h
LMT18/16 - 1800w x 1600d x 740h
LMT16/16 - 1600w x 1600d x 740h
LMT14/16 - 1400w x 1600d x 740h
LMT12/16 - 1200w x 1600d x 740h

LMT22/14 - 2200w x 1400d x 740h
LMT20/14 - 2000w x 1400d x 740h
LMT18/14 - 1800w x 1400d x 740h
LMT16/14 - 1600w x 1400d x 740h
LMT14/14 - 1400w x 1400d x 740h
LMT12/14 - 1200w x 1400d x 740h

LMT22/12 - 2200w x 1200d x 740h
LMT20/12 - 2000w x 1200d x 740h
LMT18/12 - 1800w x 1200d x 740h
LMT16/12 - 1600w x 1200d x 740h
LMT14/12 - 1400w x 1200d x 740h
LMT12/12 - 1200w x 1200d x 740h

LMT20/10 - 2000w x 1000d x 740h
LMT18/10 - 1800w x 1000d x 740h
LMT16/10 - 1600w x 1000d x 740h
LMT14/10 - 1400w x 1000d x 740h
LMT12/10 - 1200w x 1000d x 740h
LMT10/10 - 1000w x 1000d x 740h

LMT20/8 - 2000w x 800d x 740h
LMT18/8 - 1800w x 800d x 740h
LMT16/8 - 1600w x 800d x 740h
LMT14/8 - 1400w x 800d x 740h
LMT12/8 - 1200w x 800d x 740h
LMT10/8 - 1000w x 800d x 740h

Conference / Meeting

Linnea Fixed Height Meeting Tables and Accessories

MFC:	Available in Ash, Autumn Cherry, Beech, Chester Oak, English Walnut, Grey, Grey Nebraska Oak, Laurentii Wenge, Natural Nebraska Oak and White
Nanotech:	Available in Black (2 Week Lead Time)
Veneer:	Available in Oak and Walnut (3 Week Lead Time)
Edging:	Add surcharge for Wenge, Black and Plywood Effect per top - Edging on 25mm White MFC and Black Nanotech only
Metalwork:	Silver, Black Graphite and White - Add surcharge for Chrome Effect and Raw Add surcharge for Praline, Olive Green, Atlantic Blue, Sapphire Blue, Mustard Yellow, Terracotta and Conker Brown (2 Week Lead Time)
Additional:	Standard legs (no suffix) - 90 degree legs (suffix .../90 (page 62))



LMT16/12/INT

Linnea Meeting Table with Shared Inset Leg

- Standard lead times. • 25mm top panel.
- Available with 90 degree Linnea leg (see 'Additional' above).

LMT22/16/INT	- 2200w x 1600d x 740h
LMT20/16/INT	- 2000w x 1600d x 740h
LMT18/16/INT	- 1800w x 1600d x 740h
LMT16/16/INT	- 1600w x 1600d x 740h
LMT14/16/INT	- 1400w x 1600d x 740h
LMT12/16/INT	- 1200w x 1600d x 740h

LMT22/14/INT	- 2200w x 1400d x 740h
LMT20/14/INT	- 2000w x 1400d x 740h
LMT18/14/INT	- 1800w x 1400d x 740h
LMT16/14/INT	- 1600w x 1400d x 740h
LMT14/14/INT	- 1400w x 1400d x 740h
LMT12/14/INT	- 1200w x 1400d x 740h

LMT22/12/INT	- 2200w x 1200d x 740h
LMT20/12/INT	- 2000w x 1200d x 740h
LMT18/12/INT	- 1800w x 1200d x 740h
LMT16/12/INT	- 1600w x 1200d x 740h
LMT14/12/INT	- 1400w x 1200d x 740h
LMT12/12/INT	- 1200w x 1200d x 740h

LMT20/10/INT	- 2000w x 1000d x 740h
LMT18/10/INT	- 1800w x 1000d x 740h
LMT16/10/INT	- 1600w x 1000d x 740h
LMT14/10/INT	- 1400w x 1000d x 740h
LMT12/10/INT	- 1200w x 1000d x 740h
LMT10/10/INT	- 1000w x 1000d x 740h

Linnea Conference / Meeting Cable Tray

- Standard lead times. • Tray can be positioned to the users side of the workstation or towards the middle.



LINCTC24
Illustrated in red

LINCTC48	- For LCONF48 - 1030w x 116d (3x)
LINCTC44	- For LCONF44 - 1630w x 116d (2x)
LINCTC34	- For LCONF34 - 1030w x 116d (2x)
LINCTC24	- For LCONF24 - 1430w x 116d
LINCTC20	- For LCONF20 - 1030w x 116d



LDCT16/14/16D
Illustrated in red

LDCT22/14/16D	- For 2200w and 1600d and 1400d Meeting Tables - 700w x 416d (2x)
LDCT20/14/16D	- For 2000w and 1600d and 1400d Meeting Tables - 1800w x 416d
LDCT18/14/16D	- For 1800w and 1600d and 1400d Meeting Tables - 1600w x 416d
LDCT16/14/16D	- For 1600w and 1600d and 1400d Meeting Tables - 1400w x 416d
LDCT14/14/16D	- For 1400w and 1600d and 1400d Meeting Tables - 1200w x 416d
LDCT12/14/16D	- For 1200w and 1600d and 1400d Meeting Tables - 1000w x 416d



LDCT16/12D
Illustrated in red

LDCT22/12D	- For 2200w and 1200d Meeting Tables - 700w x 308d (2x)
LDCT20/12D	- For 2000w and 1200d Meeting Tables - 1800w x 308d
LDCT18/12D	- For 1800w and 1200d Meeting Tables - 1600w x 308d
LDCT16/12D	- For 1600w and 1200d Meeting Tables - 1400w x 308d
LDCT14/12D	- For 1400w and 1200d Meeting Tables - 1200w x 308d
LDCT12/12D	- For 1200w and 1200d Meeting Tables - 1000w x 308d



LMCT16
Illustrated in red

LMCT20	- For 2000w and 1000d Meeting Tables - 1630w x 116d
LMCT18	- For 1800w and 1000d Meeting Tables - 1430w x 116d
LMCT16	- For 1600w and 1000d Meeting Tables - 1230w x 116d
LMCT14	- For 1400w and 1000d Meeting Tables - 1030w x 116d
LMCT12	- For 1200w and 1000d Meeting Tables - 830w x 116d
LMCT10	- For 1000w and 1000d Meeting Tables - 630w x 116d



LRCT16
Illustrated in red

LRCT20	- For 2000w and 800d Meeting Tables - 1470w x 222d
LRCT18	- For 1800w and 800d Meeting Tables - 1270w x 222d
LRCT16	- For 1600w and 800d Meeting Tables - 1070w x 222d
LRCT14	- For 1400w and 800d Meeting Tables - 870w x 222d
LRCT12	- For 1200w and 800d Meeting Tables - 670w x 222d
LRCT10	- For 1000w and 800d Meeting Tables - 470w x 222d

Conference / Meeting

Matrix+ Fixed Height Conference and Meeting Tables

MFC: Available in Ash, Autumn Cherry, Beech, Chester Oak, English Walnut, Grey, Grey Nebraska Oak, Laurentii Wenge, Natural Nebraska Oak and White
Nanotech: Available in Black (2 Week Lead Time)
Edging: Add surcharge for Wenge, Black and Plywood Effect per top - Edging on 25mm White MFC and Black Nanotech only
Metalwork: Silver, Black Graphite and White - Underframe in Black Graphite
Add surcharge for Praline, Olive Green, Atlantic Blue, Sapphire Blue, Mustard Yellow, Terracotta and Conker Brown (2 Week Lead Time)



MPCONF34

Matrix+ Fixed Height Rectangular Conference Table

• Standard lead times. • 25mm top panel. • Underframe in Black Graphite.

MPCONF34 - 3400w x 1200d x 740h
2x 1700mm Sections - Seating up to 10 People



MPMT16/12

Matrix+ Meeting Table

• Standard lead times. • 25mm top panel. • Underframe in Black Graphite.

MPMT20/16 - 2000w x 1600d x 740h
MPMT18/16 - 1800w x 1600d x 740h
MPMT16/16 - 1600w x 1600d x 740h
MPMT14/16 - 1400w x 1600d x 740h
MPMT12/16 - 1200w x 1600d x 740h

MPMT20/14 - 2000w x 1400d x 740h
MPMT18/14 - 1800w x 1400d x 740h
MPMT16/14 - 1600w x 1400d x 740h
MPMT14/14 - 1400w x 1400d x 740h
MPMT12/14 - 1200w x 1400d x 740h

MPMT20/12 - 2000w x 1200d x 740h
MPMT18/12 - 1800w x 1200d x 740h
MPMT16/12 - 1600w x 1200d x 740h
MPMT14/12 - 1400w x 1200d x 740h
MPMT12/12 - 1200w x 1200d x 740h

MPMT20/10 - 2000w x 1000d x 740h
MPMT18/10 - 1800w x 1000d x 740h
MPMT16/10 - 1600w x 1000d x 740h
MPMT14/10 - 1400w x 1000d x 740h
MPMT12/10 - 1200w x 1000d x 740h
MPMT10/10 - 1000w x 1000d x 740h

MPMT20/8 - 2000w x 800d x 740h
MPMT18/8 - 1800w x 800d x 740h
MPMT16/8 - 1600w x 800d x 740h
MPMT14/8 - 1400w x 800d x 740h
MPMT12/8 - 1200w x 800d x 740h
MPMT10/8 - 1000w x 800d x 740h



Conference / Meeting

Matrix+ Fixed Height Meeting Tables and Accessories

MFC: Available in Ash, Autumn Cherry, Beech, Chester Oak, English Walnut, Grey, Grey Nebraska Oak, Laurentii Wenge, Natural Nebraska Oak and White
Nanotech: Available in Black (2 Week Lead Time)
Edging: Add surcharge for Wenge, Black and Plywood Effect per top - Edging on 25mm White MFC and Black Nanotech only
Metalwork: Silver, Black Graphite and White - Underframe in Black Graphite
 Add surcharge for Praline, Olive Green, Atlantic Blue, Sapphire Blue, Mustard Yellow, Terracotta and Conker Brown (2 Week Lead Time)



MPMT16/12/INT

Matrix+ Meeting Table with Shared Inset Intermediate Leg

• Standard lead times. • 25mm top panel. • Underframe in Black Graphite.

MPMT20/16/INT - 2000w x 1600d x 740h
MPMT18/16/INT - 1800w x 1600d x 740h
MPMT16/16/INT - 1600w x 1600d x 740h
MPMT14/16/INT - 1400w x 1600d x 740h
MPMT12/16/INT - 1200w x 1600d x 740h

MPMT20/14/INT - 2000w x 1400d x 740h
MPMT18/14/INT - 1800w x 1400d x 740h
MPMT16/14/INT - 1600w x 1400d x 740h
MPMT14/14/INT - 1400w x 1400d x 740h
MPMT12/14/INT - 1200w x 1400d x 740h

MPMT20/12/INT - 2000w x 1200d x 740h
MPMT18/12/INT - 1800w x 1200d x 740h
MPMT16/12/INT - 1600w x 1200d x 740h
MPMT14/12/INT - 1400w x 1200d x 740h
MPMT12/12/INT - 1200w x 1200d x 740h

MPMT20/10/INT - 2000w x 1000d x 740h
MPMT18/10/INT - 1800w x 1000d x 740h
MPMT16/10/INT - 1600w x 1000d x 740h
MPMT14/10/INT - 1400w x 1000d x 740h
MPMT12/10/INT - 1200w x 1000d x 740h
MPMT10/10/INT - 1000w x 1000d x 740h

MPMT20/8/INT - 2000w x 800d x 740h
MPMT18/8/INT - 1800w x 800d x 740h
MPMT16/8/INT - 1600w x 800d x 740h
MPMT14/8/INT - 1400w x 800d x 740h
MPMT12/8/INT - 1200w x 800d x 740h
MPMT10/8/INT - 1000w x 800d x 740h

Matrix+ Conference / Meeting Cable Tray

• Standard lead times. • Tray can be positioned to the users side of the workstation or towards the middle.



MPA7D
 Illustrated in red



MPA7
 Illustrated in red

MPA8D - For MPCONF34 - 1400w x 222d (2x)
MPA10D - For 2000w and 1600d, 1400d and 1200d Meeting Tables - 1700w x 222d
MPA9D - For 1800w and 1600d, 1400d and 1200d Meeting Tables - 1500w x 222d
MPA7D - For 1600w and 1600d, 1400d and 1200d Meeting Tables - 1300w x 222d
MPA5D - For 1400w and 1400d and 1200d Meeting Tables - 1100w x 222d
MPA3D - For 1200w and 1200d Meeting Tables - 900w x 222d
MPA10 - For 2000w and 1000d and 800d Meeting Tables - 1600w x 100d
MPA9 - For 1800w and 1000d and 800d Meeting Tables - 1400w x 100d
MPA7 - For 1600w and 1000d and 800d Meeting Tables - 1200w x 100d
MPA5 - For 1400w and 1000d and 800d Meeting Tables - 1000w x 100d
MPA3 - For 1200w and 1000d and 800d Meeting Tables - 800w x 100d
MPA2 - For 1000w and 1000d and 800d Meeting Tables - 600w x 100d

Conference / Meeting

Optima Plus Conference and Meeting Tables

MFC:	Available in Ash, Autumn Cherry, Beech, Chester Oak, English Walnut, Grey, Grey Nebraska Oak, Laurentii Wenge, Natural Nebraska Oak and White
Nanotech:	Available in Black (2 Week Lead Time)
Veneer:	Available in Oak and Walnut (3 Week Lead Time)
Edging:	Add surcharge for Wenge, Black and Plywood Effect per top - Edging on 25mm White MFC and Black Nanotech only
Metalwork:	Silver, Black Graphite and White - Add surcharge for Chrome Effect Add surcharge for Praline, Olive Green, Atlantic Blue, Sapphire Blue, Mustard Yellow, Terracotta and Conker Brown (2 Week Lead Time)



OPCONF3

Optima Plus Double 'D' Ended Conference Table

- Standard lead times. • 25mm top panel.
- 'I' frame leg configuration with modesty panel.

OPCONF3 - 4800w x 1200d x 740h
2x 1700mm and 1x 1400mm Sections - Seating up to 14 People



OPCONF2

Optima Plus Double 'D' Ended Conference Table

- Standard lead times. • 25mm top panel.
- 'I' frame leg configuration with modesty panel.

OPCONF2 - 3400w x 1200d x 740h
2x 1700mm Sections - Seating up to 10 People



OPCONF1B

Optima Plus Double 'D' Ended Conference Table

- Standard lead times. • 25mm top panel.
- 'I' frame leg configuration with modesty panel.

OPCONF1B - 2400w x 1200d x 740h
1x 2400mm Section - Seating up to 8 People

OPCONF1A - 2000w x 1200d x 740h
1x 2000mm Section - Seating up to 8 People



OPCONF1CB

Optima Plus Double 'D' Ended Conference Table

- Standard lead times. • 25mm top panel.
- 120mm diameter legs on 685mm diameter bases.

OPCONF1CB - 2400w x 1200d x 740h
1x 2400mm Section - Seating up to 8 People

OPCONF1CA - 2000w x 1200d x 740h
1x 2000mm Section - Seating up to 6 People



OPCONF1SB

Optima Plus Rectangular Conference Table

- Standard lead times. • 25mm top panel. • Supplied with MT01 bases.
- Wire managed base, 80mm aperture, located within the column.
- 100mm square column. • Heavy duty weighted 505mm square x 15mm deep base.
- Levelling feet.

OPCONF1SB - 2400w x 1200d x 740h
1x 2400mm Section - Seating up to 8 People

OPCONF1SA - 2000w x 1200d x 740h
1x 2000mm Section - Seating up to 8 People



OPDDMT24

Optima Plus Double 'D' Ended Meeting Table

- Standard lead times. • 25mm top panel.
- 'I' frame leg configuration with modesty panel.

OPDDMT26 - 2600w x 800d x 740h
OPDDMT24 - 2400w x 800d x 740h
OPDDMT22 - 2200w x 800d x 740h
OPDDMT20 - 2000w x 800d x 740h

Conference / Meeting

Optima Plus and Callisto Conference and Meeting Tables

MFC:	Available in Ash, Autumn Cherry, Beech, Chester Oak, English Walnut, Grey, Grey Nebraska Oak, Laurentii Wenge, Natural Nebraska Oak and White
Nanotech:	Available in Black (2 Week Lead Time)
Veneer:	Available in Oak and Walnut (3 Week Lead Time)
Edging:	Add surcharge for Wenge, Black and Plywood Effect per top - Edging on 25mm White MFC and Black Nanotech only
Metalwork:	Silver, Black Graphite and White - Add surcharge for Chrome Effect
	Add surcharge for Praline, Olive Green, Atlantic Blue, Sapphire Blue, Mustard Yellow, Terracotta and Conker Brown (2 Week Lead Time)



OPDMT20

Optima Plus 'D' Ended Meeting Table

- Standard lead times. • 25mm top panel.
- 'I' frame leg configuration with modesty panel.

OPDMT22	- 2200w x 800d x 740h
OPDMT20	- 2000w x 800d x 740h
OPDMT18	- 1800w x 800d x 740h
OPDMT16	- 1600w x 800d x 740h



OPRMT16

Optima Plus Rectangular Meeting Table

- Standard lead times. • 25mm top panel.
- 'I' frame leg configuration with modesty panel.

OPRMT18	- 1800w x 800d x 740h
OPRMT16	- 1600w x 800d x 740h
OPRMT14	- 1400w x 800d x 740h
OPRMT12	- 1200w x 800d x 740h



CSCT

Callisto Segué Conference Table

- Standard lead times. • 25mm top panel. • 'A' frame style leg configuration.
- Optional infill panel.

CSCT	- 4830w (extreme) x 2470d (extreme) x 740h
	6x Curved Sections and 2x Curved Corner Sections
	Seating up to 16 People



CSCTI

CSCTI	- Infill Panel Only
--------------	---------------------



CSMT

Callisto Segué Meeting Table

- Standard lead times. • 25mm top panel. • 'A' frame style leg configuration.
- Optional infill panel.

CSMT	- 2830w (extreme) x 2755d (extreme) x 740h
	3x Curved Sections and 3x Curved Corner Sections
	Seating up to 12 People



CSMTI

CSMTI	- Infill Panel Only
--------------	---------------------



COCT24

Callisto Oval Conference Table

- Standard lead times. • 25mm top panel. • 'A' frame style leg configuration.

COCT24	- 2400w x 1200d x 740h
	1x 2400mm Section - Seating up to 8 People

Conference / Meeting

Windsor Conference Tables

MFC: Available in Ash, Autumn Cherry, Beech, Chester Oak, English Walnut, Grey, Grey Nebraska Oak, Laurentii Wenge, Natural Nebraska Oak and White
Nanotech: Available in Black (2 Week Lead Time)
Veneer: Available in Oak and Walnut (3 Week Lead Time)
Edging: Add surcharge for Wenge, Black and Plywood Effect per top - Edging on 25mm White MFC and Black Nanotech only
Metalwork: Silver, Black Graphite and White



CONF2AL

Windsor Double 'D' Ended Conference Table

- Standard lead times. • 25mm top panel.
- Arrowhead leg configuration with modesty panel.

CONF2AL - 3400w x 1200d x 740h
2x 1700mm Sections - Seating up to 10 People



DDT24

Windsor Double 'D' Ended Conference Table

- Standard lead times. • 25mm top panel.
- Arrowhead leg configuration with modesty panel.

DDT24 - 2400w x 1200d x 740h
1x 2400mm Section - Seating up to 8 People



OVT24

Windsor Oval Conference Table

- Standard lead times. • 25mm top panel.
- Arrowhead leg configuration with modesty panel.

OVT24 - 2400w x 1200d x 740h
1x 2400mm Section - Seating up to 8 People



BST24

Windsor Barrel Conference Table

- Standard lead times. • 25mm top panel.
- Arrowhead leg configuration with modesty panel.

BST24 - 2400w x 1200d x 740h
1x 2400mm Section - Seating up to 8 People



Conference / Meeting

Flare Boardroom Storage Unit

MFC:	Available in Ash, Autumn Cherry, Beech, Chester Oak, English Walnut, Grey, Grey Nebraska Oak, Laurentii Wenge, Natural Nebraska Oak and White
Nanotech:	Available in Black (2 Week Lead Time)
Veneer:	Available in Oak and Walnut (3 Week Lead Time)
Coloured:	Specific items available in Praline, Olive Green, Atlantic Blue, Sapphire Blue, Mustard Yellow, Terracotta and Conker Brown (2 Week Lead Time)
Edging:	Add surcharge for Wenge, Black and Plywood Effect per top - Edging on 25mm White MFC and Black Nanotech only



FLA7/5/D4



FLA7/5/D3



FLA7/5/D2

Flare Boardroom Storage Unit

- Standard lead time. • 25mm top panel. • 2 / 3 / 4x soft close hinged door mechanisms. • Lockable, includes 2x keys.
- All units supplied with 1 piece top and bottom. • Contrasting doors available on MFC and Black Nanotech only.
- Alternative handles available (page 222). • Additional shelves available (page 161).

4 Doors with 2x Adjustable Shelves

- FLA9/6/D4...** - 2000w x 600d x 900h
FLA9/5/D4... - 2000w x 500d x 900h

- FLA7/6/D4...** - 2000w x 600d x 740h
FLA7/5/D4... - 2000w x 500d x 740h

3 Doors with 2x Adjustable Shelves

- FLA9/6/D3...** - 1500w x 600d x 900h
FLA9/5/D3... - 1500w x 500d x 900h

- FLA7/6/D3...** - 1500w x 600d x 740h
FLA7/5/D3... - 1500w x 500d x 740h

2 Doors with 1x Adjustable Shelf

- FLA9/6/D2...** - 1000w x 600d x 900h
FLA9/5/D2... - 1000w x 500d x 900h

- FLA7/6/D2...** - 1000w x 600d x 740h
FLA7/5/D2... - 1000w x 500d x 740h

Finishes: Silver (.../SF), Black Graphite (.../BGF) and White (.../WF) Legs
 Add surcharge for Raw Metalwork (.../RF), Black (.../BF), Praline (.../PLF), Olive Green (.../OVF), Atlantic Blue (.../ABF), Sapphire Blue (.../SBF), Mustard Yellow (.../MYF), Terracotta (.../TCF), Conker Brown (.../CBF) and Chrome Effect (.../CF) Legs

Finishes: Standard MFC Contrasting Door Finish (.../CON)
 Add surcharge (on MFC) per door for Coloured MFC Contrasting Door Finish (.../CON)
 Add surcharge (on MFC) per door for Nanotech Contrasting Door Finish (.../CON)
 Further information required, contact Customer Services for a specification form

Handles: Standard Handles
 Add surcharge per door for Push release Open/Close Mechanism (.../PH)

Additional: Add surcharge per Fridge Cut-Out on 600d Double Door Sections only (.../FDG) (page 161)



Showing Push release Open/Close Mechanism

Conference / Meeting

Combined Boardroom Storage Unit and Accessories

MFC:	Available in Ash, Autumn Cherry, Beech, Chester Oak, English Walnut, Grey, Grey Nebraska Oak, Laurentii Wenge, Natural Nebraska Oak and White
Nanotech:	Available in Black (2 Week Lead Time)
Veneer:	Available in Oak and Walnut (3 Week Lead Time)
Coloured:	Specific items available in Praline, Olive Green, Atlantic Blue, Sapphire Blue, Mustard Yellow, Terracotta and Conker Brown (2 Week Lead Time)
Edging:	Add surcharge for Wenge, Black and Plywood Effect per top - Edging on 25mm White MFC and Black Nanotech only



CSU7/5/D4



CSU7/5/D3



CSU7/5/D2

Combined Storage Unit

- Standard lead time.
- 25mm top panel.
- 2 / 3 / 4x soft close hinged door mechanisms.
- Lockable, includes 2x keys.
- 1000w and 1500w units supplied with 1 piece top and bottom.
- 2000w units supplied with 1 piece top and 2 piece bottom.
- Contrasting doors available on MFC and Black Nanotech only.
- Alternative handles available (page 222).
- Additional shelves available (see below).

4 Doors with 2x Adjustable Shelves

- CSU9/6/D4** - 2000w x 600d x 900h
- CSU9/5/D4** - 2000w x 500d x 900h

- CSU7/6/D4** - 2000w x 600d x 740h
- CSU7/5/D4** - 2000w x 500d x 740h

3 Doors with 2x Adjustable Shelves

- CSU9/6/D3** - 1500w x 600d x 900h
- CSU9/5/D3** - 1500w x 500d x 900h

- CSU7/6/D3** - 1500w x 600d x 740h
- CSU7/5/D3** - 1500w x 500d x 740h

2 Doors with 1x Adjustable Shelf

- CSU9/6/D2** - 1000w x 600d x 900h
- CSU9/5/D2** - 1000w x 500d x 900h

- CSU7/6/D2** - 1000w x 600d x 740h
- CSU7/5/D2** - 1000w x 500d x 740h

Finishes:	Standard MFC Contrasting Door Finish (.../CON) Add surcharge (on MFC) per door for Coloured MFC Contrasting Door Finish (.../CON) Add surcharge (on MFC) per door for Nanotech Contrasting Door Finish (.../CON) <i>Further information required, contact Customer Services for a specification form</i>
Handles:	Standard Handles Add surcharge per door for Push release Open/Close Mechanism (.../PH)
Additional:	Add surcharge per Fridge Cut-Out on 600d Double Door Sections only (.../FDG) (see below)



FLA7/6/D2/FDG1

Flare Boardroom and Combined Storage Unit Cut-Out for Fridge

- Standard lead time.
- Applies a cut-out to the chosen back section of the 600d Double Door Section of the unit only.
- Extra panels are added to divide the remaining internal space.
- To apply a fridge cut-out to the 600d Flare Boardroom and Combined Storage Units, suffix .../FDG to your chosen unit and refer to the '123' guide below.
- Section numbers always start from left-hand section.

- .../FDG1** - Cut-Out in Section 1 on 2, 3 and 4 Door Units
- .../FDG2** - Cut-Out in Section 2 on 2, 3 and 4 Door Units
- .../FDG3** - Cut-Out in Section 3 on 4 Door Units
- .../FDG4** - Cut-Out in Section 4 on 4 Door Units



- A Section 1**
- B Section 2**
- C Section 3**
- D Section 4**



CSU/5/S/D2

Flare Boardroom and Combined Storage Unit Adjustable Shelves

- Standard lead time.

- CSU/5/S/D1** - For Single Section 3 Door 500d Units - 472w x 408d x 18h
- CSU/5/S/D2** - For 2 / 4 Door 500d Units - 963w x 408d x 18h
- CSU/5/S/D3** - For Double Section 3 Door 500d Units - 972w x 408d x 18h
- CSU/6/S/D1** - For Single Section 3 Door 600d Units - 472w x 508d x 18h
- CSU/6/S/D2** - For 2 / 4 Door 600d Units - 963w x 508d x 18h
- CSU/6/S/D3** - For Double Section 3 Door 600d Units - 972w x 508d x 18h

Conference / Meeting

Switch Mobile Whiteboard TV Unit

4 Week Lead Time

MFC:	Available in Ash, Autumn Cherry, Beech, Chester Oak, English Walnut, Grey, Grey Nebraska Oak, Laurentii Wenge, Natural Nebraska Oak and White
Coloured:	Available in Praline, Olive Green, Atlantic Blue, Sapphire Blue, Mustard Yellow, Terracotta and Conker Brown
Nanotech:	Available in Black (2 Week Lead Time)
Metalwork:	Silver, Black Graphite and White
Fabric:	Fully upholstered - See below for pricing groups



SWI/MTVU/TV



SWI/MTVU/TV

Switch Mobile TV and Whiteboard Unit

- Compatible with TVs with a maximum weight of 16kg.
- 4 week lead time.
- 55" 4K TV (Branded), mounted by special hinged bracket.
- Flush mount surface power and media module (1x power socket, 1x USB twin charger (A+C), 1x HDMI and 1x USB (A)).
- Magnetic dry wipe whiteboard is 1310w x 1010h.
- Designer castors.
- Power connection via side panel.
- Supplied with 3m 90 degree IEC power cable as standard.

SWI/MWTVU/TV - 1400w x 535d x 1890h

Fabric Groups: Group 1 - Add surcharge for Group 2-7



IEC90/5

IEC 90 Degree Power Cable

- Above supplied with 3000w as standard - see alternative below.
- Standard lead time.
- Black cable and plug.
- 13amp fused.

IEC90/7 - 7000mm
IEC90/5 - 5000mm
IEC90/2 - 2000mm

Conference / Meeting

Mobile Whiteboard Unit

Metalwork:

Silver, Black Graphite and White

Add surcharge for Praline, Olive Green, Atlantic Blue, Sapphire Blue, Mustard Yellow, Terracotta and Conker Brown (2 Week Lead Time)



MWBP

Mobile Portrait Whiteboard Unit

- Standard lead time.
- Mobile drywipe whiteboard.
- Portrait (900w x 1200h) orientation.
- 360 degree rotation.
- Magnetic.
- Storage tray.
- 2x locking castors.

MWBP - 1000w x 620d x 1850h

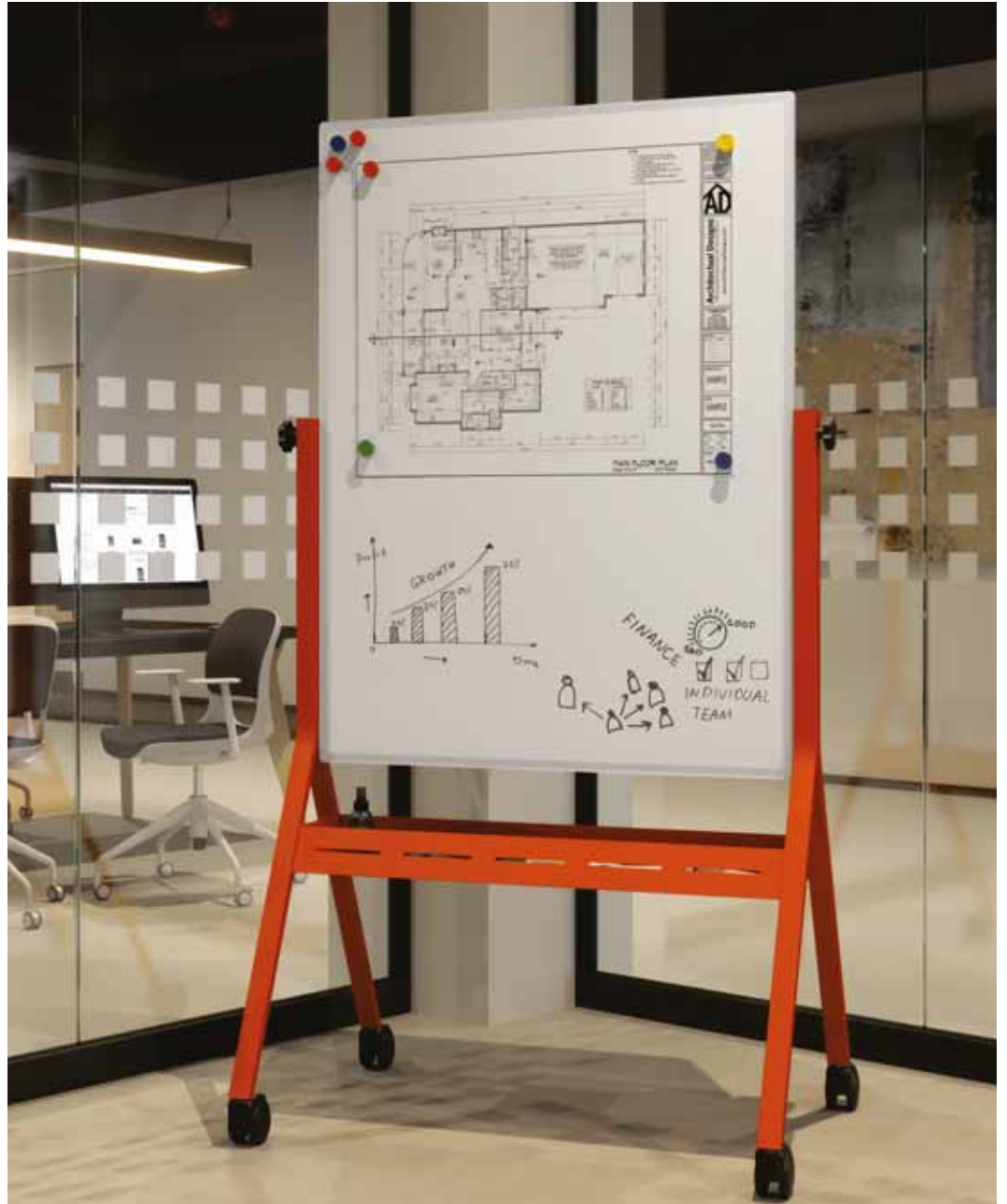

MWBL

Mobile Landscape Whiteboard Unit

- Standard lead time.
- Mobile drywipe whiteboard.
- Landscape (1200w x 900h) orientation.
- 360 degree rotation.
- Magnetic.
- Storage tray.
- 2x locking castors.

MWBL - 1300w x 620d x 1700h

Conference / Meeting

Power Modules

Finishes: **Kaspa:** Available in Silver with Black Inserts, Black with Black Inserts and Matt White with Black Inserts
Prime: Available in Silver with Black Inserts, Black with Black Inserts and Matt White with Black Inserts
Guarantee: 1 Year Guarantee on Electrical Items



POW/KAS/2P1T/S

Kaspa Power and Media Module

- Standard lead time.
- 1x or 2x 3.15 amp individually fused sockets.
- 1x USB twin charger (type A+C).
- Integral colour coded fuse clips.
- 200mm power and connection lead to a Wieland connector.
- Fixing via 135w x 53d (1 gang) or 189w x 53d (2 gang) aperture.
- Requires a separate mains lead if connecting directly into a socket (page 171).

POW/KAS/1P1T... - 1x Power, 1x USB Twin Charger - 151w x 70d

POW/KAS/2P1T... - 2x Power, 1x USB Twin Charger - 204w x 70d

Finishes: Silver (.../S), Black (.../B) and White (.../W)



POW/KAS/1P1T/S
Silver with Black Inserts



POW/KAS/1P1T/B
Black with Black Inserts



POW/KAS/1P1T/W
White with Black Inserts



POW/PRI/2P1T/S

Prime Power and Media Module

- Standard lead time.
- 2x 3.15 amp individually fused sockets.
- 1x USB twin charger (type A+C).
- 200mm power and connection lead to a Wieland connector.
- Fixing via 225w x 60d aperture.
- Requires a separate mains lead if connecting directly into a socket (page 171).

POW/PRI/2P1T... - 2x Power, 1x USB Twin Charger - Without Cover - 241w x 73d

Finishes: Silver (.../S), Black (.../B) and White (.../W)



POW/PRI/2P1T/S
Silver with Black Inserts



POW/PRI/2P1T/B
Black with Black Inserts



POW/PRI/2P1T/W
White with Black Inserts



POW/PRI/2P1T/C/B

Prime Power and Media Module With Cover

- Standard lead time.
- 2x 3.15 amp individually fused sockets.
- 1x USB twin charger (type A+C).
- 200mm power and connection lead to a Wieland connector.
- Fixing via 225w x 60d aperture.
- Casing provided to discretely protect cables and sockets.
- Requires a separate mains lead if connecting directly into a socket (page 171).

POW/PRI/2P1T/C... - 2x Power, 1x USB Twin Charger - With Cover - 257w x 88d

Finishes: Silver (.../S), Black (.../B) and White (.../W)



POW/PRI/2P1T/C/S
Silver with Black Inserts



POW/PRI/2P1T/C/B
Black with Black Inserts



POW/PRI/2P1T/C/W
White with Black Inserts

Conference / Meeting

Power Modules

3 Week Lead Time

Finishes:
Guarantee:

Boardroom: Available in Silver with Grey Trim, Black with Black Trim and Matt White with Grey Trim (3 Week Lead Time on Black and White)
1 Year Guarantee on Electrical Items



PPM2/S

Boardroom Power Module

- 3 week lead time on black and white power modules. • BS6396 compliant. • 2x or 4x 3.15 amp individually fused sockets.
- Fixing via 272w x 132d (2 gang) or 430w x 132d (4 gang) aperture.
- Requires a separate mains lead if connecting directly into a socket (page 171).

PPM2... - 2x Power - 300w x 150d

Finishes: Silver (.../S)
Add surcharge for Black (.../B) and White (.../W)



PPM4/S

PPM4... - 4x Power - 460w x 150d

Finishes: Silver (.../S)
Add surcharge for Black (.../B) and White (.../W)



PPMD2/S

Boardroom Power and Data Module

- 3 week lead time on black and white power modules. • BS6396 compliant.
- 2x or 4x 3.15 amp individually fused sockets. • 2x Cat5e data sockets, includes 3 metre data cable.
- Fixing via 272w x 132d (2 gang) or 430w x 132d (4 gang) aperture.
- Requires a separate mains lead if connecting directly into a socket (page 171).

PPMD2... - 2x Power, Data - 300w x 150d

Finishes: Silver (.../S)
Add surcharge for Black (.../B) and White (.../W)



PPMD4/S

PPMD4... - 4x Power, Data - 460w x 150d

Finishes: Silver (.../S)
Add surcharge for Black (.../B) and White (.../W)



PPMMD2/S

Boardroom Power, Media and Data Module

- 3 week lead time on black and white power modules. • BS6396 compliant. • 2x or 4x 3.15 amp individually fused sockets.
- 2x Cat5e data sockets, includes 3 metre data cable. • 1x USB twin charger (type A+C).
- 1x VGA and 1x 3.5mm audio stereo connectors. • 1x HDMI 1.3 connector.
- Includes ratchet clips and earthing kit. • Fixing via 272w x 132d (2 gang) or 430w x 132d (4 gang) aperture.
- Requires a separate mains lead if connecting directly into a socket (page 171).

PPMMD2... - 2x Power, Media, Data - 300w x 150d

Finishes: Silver (.../S)
Add surcharge for Black (.../B) and White (.../W)



PPMMD4/S

PPMMD4... - 4x Power, Media, Data - 460w x 150d

Finishes: Silver (.../S)
Add surcharge for Black (.../B) and White (.../W)



PPM2/S
Silver Body with Grey Trim



PPM2/B
Black Body with Black Trim
(3 Week Lead Time)



PPM2/W
White Body with Grey Trim
(3 Week Lead Time)

Conference / Meeting

Power Modules

Finishes:
Guarantee:

Conus: Available in Silver with Black Inserts, Black with Black Inserts and Matt White with Black Inserts
1 Year Guarantee on Electrical Items



POW/CON/2P1D/S

Conus Boardroom Power Module

- **Conus Data Options are required with this product (see below).**
- Standard lead time.
- 2x or 4x 3.15 amp individually fused sockets.
- Available with 1x or 2x various additional data options (see below).
- Suffix 1x data option onto 2 Gang versions (e.g. POW/CON/2P1D/S/OP2) and 2x data options onto 4 Gang versions (e.g. POW/CON/4P2D/S/OP1/OP3).
- 200mm power and connection lead to a Wieland connector.
- Fixing via 230w x 138d (2 gang) or 369w x 138d (4 gang) aperture.
- Requires a separate mains lead if connecting directly into a socket (page 171).

POW/CON/2P1D... - 2x Power, 1x Data Blank - 255w x 151d

POW/CON/4P2D... - 4x Power, 2x Data Blanks - 387w x 151d

Finishes: Silver (.../S), Black (.../B) and White (.../W)



POW/CON/2P1D/S
Silver with Black Inserts



POW/CON/2P1D/B
Black with Black Inserts



POW/CON/2P1D/W
Matt White with Black Inserts

Conus Data Options

- Standard lead time.
- Suffix 1x data option onto 2 Gang versions (e.g. POW/CON/2P1D/S/OP2) and 2x data options onto 4 Gang versions (e.g. POW/CON/4P2D/S/OP1/OP3).

- .../OP1** - HDMI Module with 3m Tails
- .../OP2** - VGA and 3.5mm Combined Audio Extension Module with 3m Tails
- .../OP3** - USB Twin Charger Module (Type A+C)
- .../OP4** - 2x Cat6A Data Connector Module with 3m Tails
- .../OP5** - Blank Module Plate



.../OP1



.../OP2



.../OP3



.../OP4



.../OP5



Conference / Meeting

Power Modules

3 Week Lead Time

Finishes: **Peak:** Available in Stainless Steel Silver with Black Inserts, Black with Black Inserts and Matt White with Grey Inserts (3 Week Lead Time)
Escalate: Available in Silver Only
Guarantee: 1 Year Guarantee on Electrical Items



PEAPM60/S



PEAPM80/B

Peak Power and Media Module

- 3 week lead time.
- 4x or 6x 3.15 amp individually fused sockets.
- 2x USB twin charger (type A+C).
- Integral colour coded fuse clips.
- Hardwired 800mm lead to Wieland connector.
- Includes 4x screw clamps.
- Fixing via 194w x 134d (4 gang) or 274w x 134d (6 gang) aperture.
- Requires a separate mains lead if connecting directly into a socket (page 171).

PEAPM60 - 4x Power, 2x USB Twin Charger - 220w x 155d

Finishes: Silver (.../S)
 Add surcharge for Black (.../B) and White (.../W)

PEAPM80 - 6x Power, 2x USB Twin Charger - 300w x 155d

Finishes: Silver (.../S)
 Add surcharge for Black (.../B) and White (.../W)



PEAPM60/S
 Stainless Steel Silver with Black Inserts



PEAPM80/B
 Black with Black Inserts



PEAPM80/W
 Matt White with Grey Inserts



POW/ESC/1P1T/S



POW/ESC/1P1T/S

Escalate Power and Media Module

- Standard lead time.
- 1x 3.15 amp individually fused socket.
- 1x USB twin charger (type A+A).
- 500mm power and connection lead to Wieland connector.
- Fixing via 80w (dia) porthole aperture.
- Requires a separate mains lead if connecting directly into a socket (page 171).

POW/ESC/1P1T/S - 1x Power, 1x USB Twin Charger - Silver - 95w (dia) x 230h

Conference / Meeting

Power Modules

Finishes:

WCU: Available in Black, Black with Aluminium Trim, Black Glass, White, White with Aluminium Trim and White Glass (3 Week Lead Time)

Dual Pro WCU: Available in Black Glass with Silver Base, White Glass with Silver Base, Black Glass with Black Base and White Glass with Black Base
1 Year Guarantee on Electrical Items

Guarantee:



WCU/BB

Wireless Charging Unit

- Standard lead time. • Charge smartphones and tablets wirelessly. • Fixing via 80w porthole aperture.
- Charging unit complete with 15W USB power plug.
- Wireless Charging Receiver required when device does not support wireless charging.

WCU... - Charging Unit - 85w (dia)

Finishes:

Black (.../BB) and White (.../WW)

Add surcharge for Aluminium Black (.../AB) and Aluminium White (.../AW)

Add surcharge for Black Glass (.../BG) and White Glass (.../WG)



WCU/BB
Black



WCU/AB
Black with Aluminium Trim



WCU/BG
Black Glass



WCU/WW
White



WCU/AW
White with Aluminium Trim



WCU/WG
White Glass



WCU/DP/BGB

Dual Pro Wireless Charging Unit

- Standard lead time. • Lid cover slides to reveal 3x USB chargers (type A+A+C).
- Charge smartphones and tablets wirelessly. • 65W laptop charging without a traditional brick power cord.
- Fixing via 80w porthole aperture. • Charging unit complete with USB power plug.
- Wireless Charging Receiver required when device does not support wireless charging.

WCU/DP... - Dual Pro Charging Unit - 203w x 93d x 8h

Finishes:

Black Glass with Silver Base (.../BGS), White Glass with Silver Base (.../WGS),

Black Glass with Black Base (.../BGB) and White Glass with Black Base (.../WGB)



WCU/DP/BGS
Black Glass with Silver Base



WCU/DP/WGS
White Glass with Silver Base



WCU/DP/BGB
Black Glass with Black Base



WCU/DP/WGB
White Glass with Black Base



WCU/WCR

Wireless Charging Receiver

- Standard lead time. • Charge smartphones and tablets wirelessly.
- Wireless Charging Unit required to support wireless charging.

WCU/WCR - Wireless Charging Receiver

Conference / Meeting

Power Modules

Finishes: **Port Hole:** Available in Grey, Black and White
Pix: Available in Black with Silver Trim and White with White Trim
Guarantee: 1 Year Guarantee on Electrical Items



PHPM/G

Port Hole Power and Media Module

- Standard lead time. • 1x 3.15 amp individually fused socket. • 1x USB twin charger (type A+C).
- 1m connection lead. • Fixing via 80w porthole aperture.
- Requires a separate mains lead if connecting directly into a socket (page 171).

PHPM - 1x Power, 1x USB Twin Charger - 95w (dia)

Finishes: Grey (.../G), Black (.../B) and White (.../W)



PHPM/G
Grey



PHPM/B
Black



PHPM/W
White



POW/PIX/1P1T/B

Pix Power and Media Module

- Standard lead time. • 1x 3.15 amp individually fused socket. • 1x USB twin charger (type A+C).
- 800mm connection lead. • Fixing via 80w porthole aperture.
- Requires a separate mains lead if connecting directly into a socket (page 171).

POW/PIX/1P1T... - 1x Power, 1x USB Twin Charger - 90w (dia) x 16h

Finishes: Black (.../B) and White (.../W)



POW/PIX/1P1T/B
Black



POW/PIX/1P1T/W
White



Conference / Meeting

Power Modules

Finishes: **Pluto:** Available in Grey with Black Inserts, Black with Grey Inserts and White with Grey Inserts
Inca: Available in Grey, Black and White
Guarantee: 1 Year Guarantee on Electrical Items



PLU/3P/G

Pluto Power Module

- Standard lead time.
- 3.15 amp individually fused sockets.
- Optional USB twin charger (type A+C).
- Fixing via 80w porthole aperture.
- Requires a separate mains lead if connecting directly into a socket (page 171).

PLU/3P... - 3x Power - 140w (dia) x 73h

Finishes: Grey with Black Inserts (.../G), Black with Grey Inserts (.../B) and White with Grey Inserts (.../W)



PLU/2P/1USB/G

PLU/2P/1USB... - 2x Power, 1x USB Twin Charger - 140w (dia) x 73h

Finishes: Grey with Black Inserts (.../G), Black with Grey Inserts (.../B) and White with Grey Inserts (.../W)



PLU/2P/1USB/G
Grey



PLU/2P/1USB/B
Black



PLU/2P/1USB/W
White



IPM/G

Inca Power and Media Module

- Standard lead time.
- 2x 3.15 amp individually fused sockets.
- 2x USB twin chargers (type A+C).
- Power and connection lead to 3 pole connector.
- Fixing via 80w porthole aperture.
- Requires a separate mains lead if connecting directly into a socket (page 171).

IPM... - 2x Power, 2x USB Twin Charger - 140w x 140d x 72h

Finishes: Grey (.../G), Black (.../B) and White (.../W)



IPM/G
Grey



IPM/B
Black



IPM/W
White

Conference / Meeting

Accessories and Compatibility Breakdown

Guarantee: 1 Year Guarantee on Electrical Items



Wieland Mains Cable

- Standard lead time.
- Black cable and plug.
- 13amp fused.

- 7M** - 7000mm
- 5M** - 5000mm
- 3M** - 3000mm
- 2M** - 2000mm

5M



Wieland Interconnection Cable

- Standard lead time.
- Black cable and interconnection plugs.
- Male and female connectors.

- CL20** - 2000mm
- CL10** - 1000mm
- CL5** - 500mm

CL10



IEC 90 Degree Power Cable

- Standard lead time.
- Black cable and plug.
- 13amp fused.

- IEC90/7** - 7000mm
- IEC90/5** - 5000mm
- IEC90/3** - 3000mm
- IEC90/2** - 2000mm

IEC90/5

Conference / Meeting Compatibility Breakdown

- **Black** - Compatible
- **Red** - May not support larger modules

- Conference / Meeting - Aerofoil
- Conference / Meeting - Qube 1200d
- Conference / Meeting - Qube 1000d
- Conference / Meeting - All other Qube

	Power and Data Modules															
	Kaspa, page 294	Prime, page 294	Boardroom, page 295	Conus, page 296	Peak, page 297	Escalate, page 297	Wireless Charging Unit, page 298	Port Hole, page 299	Pix, page 299	Pluto, page 300	Inca, page 300	Flex, page 301	Boost, page 301	Capsule, page 302	Plaza, page 303	Wieland Socket Boxes, page 303
Conference / Meeting - Aerofoil	●	●	●	●	●	●	●	●	●	●	●	●	●	●		
Conference / Meeting - Qube 1200d	●	●	●	●	●	●	●	●	●	●	●	●	●	●		
Conference / Meeting - Qube 1000d	●	●														
Conference / Meeting - All other Qube	●	●	●	●	●	●	●	●	●	●	●	●	●	●		

Benches

Alto, Harmony, Loco, Cubeform, Lux and Forte Ranges



With the increase of employers seeking a more diverse, intelligent approach to desking and agile working, our Bench portfolio has been designed to provide an alternative place of working, meeting and collaborating with a range of solutions to suit all environments and requirements. For use as in-office touchdown points, a number of bench tables are offered at 740mm high with complementing bench seats.



Benches

Alto Canopy

MFC:	Available in Ash, Autumn Cherry, Beech, Chester Oak, English Walnut, Grey, Grey Nebraska Oak, Laurentii Wenge, Natural Nebraska Oak and White
Nanotech:	Available in Black (2 Week Lead Time) - Undercut Edging detail option available (Contact Customer Services)
Veneer:	Available in Oak and Walnut (3 Week Lead Time)
Solid Wood:	Available in Oak (3 Week Lead Time) - Tops are 32mm thick
Edging:	Add surcharge for Wenge, Black and Plywood Effect per top - Edging on 25mm White MFC and Black Nanotech only
Metalwork:	Silver, Black Graphite and White - Add surcharge for Chrome Effect and Raw Add surcharge for Praline, Olive Green, Atlantic Blue, Sapphire Blue, Mustard Yellow, Terracotta and Conker Brown (2 week lead time)



ABC24/12

Alto Canopy High Bench with Support Frame

- Standard lead times. • 3 week lead time on Benches with Nanotech, Veneer and Solid Oak.
- 25mm MFC, Nanotech and Veneer top panels and 32mm Solid Oak top panels, all with radiused corners.
- Heavy duty 'A' frame canopy legs with cross bracing frame. • Mesh canopy.
- MFC, Nanotech and Veneer desktops are 1050h and Solid Oak desktops are 1057h.
- Available with undercut edging detail (Nanotech only - contact customer services).
- Available with optional Lighting Kit (page 171).

ABC28/12 - 2800w x 1200d x 2100h

ABC26/12 - 2600w x 1200d x 2100h

ABC24/12 - 2400w x 1200d x 2100h



ABC24/12/INT

Alto Canopy High Bench with Support Frame and Shared Intermediate Leg

- Standard lead times. • 3 week lead time on Benches with Nanotech, Veneer and Solid Oak.
- 25mm MFC, Nanotech and Veneer top panels and 32mm Solid Oak top panels, all with radiused corners.
- Heavy duty 'A' frame canopy legs with cross bracing frame. • Mesh canopy.
- MFC, Nanotech and Veneer desktops are 1050h and Solid Oak desktops are 1057h.
- Available with undercut edging detail (Nanotech only - contact customer services).
- Available with optional Lighting Kit (page 171).

ABC28/12/INT - 2800w x 1200d x 2100h

ABC26/12/INT - 2600w x 1200d x 2100h

ABC24/12/INT - 2400w x 1200d x 2100h



Benches

Alto Canopy

MFC:	Available in Ash, Autumn Cherry, Beech, Chester Oak, English Walnut, Grey, Grey Nebraska Oak, Laurentii Wenge, Natural Nebraska Oak and White
Nanotech:	Available in Black (2 Week Lead Time) - Undercut Edging detail option available (Contact Customer Services)
Veneer:	Available in Oak and Walnut (3 Week Lead Time)
Solid Wood:	Available in Oak (3 Week Lead Time) - Tops are 32mm thick
Edging:	Add surcharge for Wenge, Black and Plywood Effect per top - Edging on 25mm White MFC and Black Nanotech only
Metalwork:	Silver, Black Graphite and White - Add surcharge for Chrome Effect and Raw Add surcharge for Praline, Olive Green, Atlantic Blue, Sapphire Blue, Mustard Yellow, Terracotta and Conker Brown (2 week lead time)



ABCL24/12

Alto Canopy Low Bench

- Standard lead times. • 3 week lead time on Benches with Nanotech, Veneer and Solid Oak.
- 25mm MFC, Nanotech and Veneer top panels and 32mm Solid Oak top panels, all with radiused corners.
- Heavy duty 'A' frame canopy legs. • Mesh canopy.
- MFC, Nanotech and Veneer desktops are 740h and Solid Oak desktops are 747h.
- Available with undercut edging detail (Nanotech only - contact customer services).
- Available with optional Lighting Kit (page 171).

ABCL28/12 - 2800w x 1200d x 2100h

ABCL26/12 - 2600w x 1200d x 2100h

ABCL24/12 - 2400w x 1200d x 2100h



ABCL24/12/INT

Alto Canopy Low Bench with Shared Intermediate Leg

- Standard lead times. • 3 week lead time on Benches with Nanotech, Veneer and Solid Oak.
- 25mm MFC, Nanotech and Veneer top panels and 32mm Solid Oak top panels, all with radiused corners.
- Heavy duty 'A' frame canopy legs. • Mesh canopy.
- MFC, Nanotech and Veneer desktops are 740h and Solid Oak desktops are 747h.
- Available with undercut edging detail (Nanotech only - contact customer services).
- Available with optional Lighting Kit (page 171).

ABCL28/12/INT - 2800w x 1200d x 2100h

ABCL26/12/INT - 2600w x 1200d x 2100h

ABCL24/12/INT - 2400w x 1200d x 2100h



ABCL24/12/C

Alto Canopy Low Bench with Castors

- Standard lead times. • 3 week lead time on Benches with Nanotech, Veneer and Solid Oak.
- 25mm MFC, Nanotech and Veneer top panels and 32mm Solid Oak top panels, all with radiused corners.
- Heavy duty 'A' frame canopy legs. • 75mm grey rubber castors with brakes. • Mesh canopy.
- MFC, Nanotech and Veneer desktops are 740h and Solid Oak desktops are 747h.
- Available with undercut edging detail (Nanotech only - contact customer services).
- Available with optional Lighting Kit (page 171).

ABCL28/12/C - 2800w x 1200d x 2100h

ABCL26/12/C - 2600w x 1200d x 2100h

ABCL24/12/C - 2400w x 1200d x 2100h



Benches

Alto Canopy Accessories

Metalwork:

Silver, Black Graphite and White - Add surcharge for Chrome Effect and Raw
Add surcharge for Praline, Olive Green, Atlantic Blue, Sapphire Blue, Mustard Yellow, Terracotta and Conker Brown (2 week lead time)



ABC24/12

Alto Bench Canopy Lighting Kit

- Standard lead times.
- Non-retrofitable.
- Can be installed on all Alto Bench Canopies at point of purchase.
- Single switch to activate all 5 pendant lights at once.

.../LK



ABCCR

Bench Cable Riser

- Standard lead times.
- Single channel cable riser.

ABCCR - For Alto Bench Canopy with 1050/1057h Desktops

ABCLCR - For Alto Bench Canopy with 740/747h Desktops

ABCLCR/C - For Alto Bench Canopy with Castors and 740/747h Desktops



ABCCT28

Horizontal Cable Tray

- Standard lead times.
- Cable trays are 100mm deep and 110mm high.
- Tray can be positioned to the users side of the workstation or towards the rear.

ABCCT28 - For 2800w Alto Bench Canopy - 2300w

ABCCT26 - For 2600w Alto Bench Canopy - 2100w

ABCCT24 - For 2400w Alto Bench Canopy - 1900w



LGT/B/ED1

Alto Canopy Edison Squirrel Light (ST64)

- Standard lead times.
- Replacement bulb.
- E27 ES LED cap size.
- 240 volts.
- 4 watts.
- Smoked spiral filament
- 100 lumen.
- 2000 Kelvin (extra warm / candle light).
- 15,000 hours nominal life.
- Bulb size 64w (dia) x 142h.

LGT/B/ED1



LGT/B/ED2

Alto Canopy Edison Globe Light (G125)

- Standard lead times.
- Replacement bulb.
- E27 ES LED cap size.
- 240 volts.
- 4 watts.
- Smoked spiral filament
- 100 lumen.
- 2000 Kelvin (extra warm / candle light).
- 15,000 hours nominal life.
- Bulb size 125w (dia) x 167h.

LGT/B/ED2

Benches

Alto Canopy Accessories



ABC/PLT1
(Multiple Plants Included)

Alto Canopy Bench Garland Pack

- Standard lead times. • Can be installed on all Alto Bench Canopies after purchase.
- Pack contains 3x Faux Ivy Garland Green Vines, 3x Faux Ivy Garland Green Variegated Vines and 4 x Faux Silk Silver Dollar Eucalyptus Garlands. • UV stable and wont fade in strong sunlight. • Maintenance free.
- Main stem can be moulded into position.

ABC/PLT1

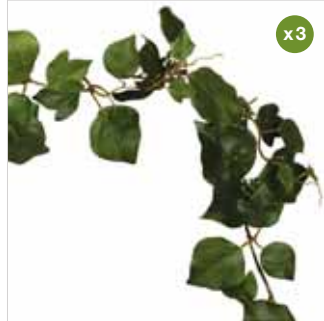

Faux Ivy Garland Green Vine

- Realistic dark green leaf ivy with brown / green branch stems.
- 1830w x 160d.

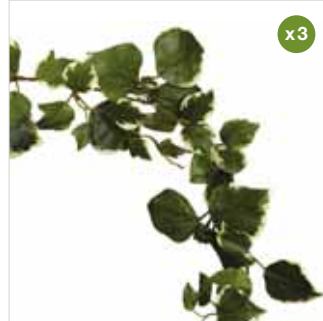

Faux Ivy Garland Green Variegated Vine

- Realistic dark green leaf and cream tipped ivy with brown / green branch stems.
- 1830w x 160d.

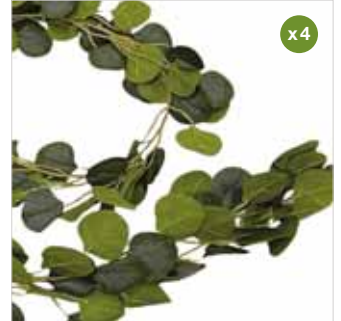

Faux Silk Silver Dollar Eucalyptus Garland

- Green Lamb Ear garland with brown/green branch stems.
- 1950w x 160d.



ABC/PLT/CT

Alto Canopy Bench Garland Pack Cable Ties

- Standard lead times. • Cable Ties for securing Garland Pack onto Canopy mesh frame.
- Can be installed on all Alto Bench Canopies after purchase. • Pack contains 100 x Black Cable Ties - 80w x 2.5d.

ABC/PLT1/CT - Pack of 100



ABC/PLT2

Alto Canopy Bench Trailing Buxus Pack

- Standard lead times. • Pack contains 9x realistic Trailing Buxus Plants.
- UV stable and wont fade in strong sunlight. • Fire retardant. • Maintenance free. • Recyclable.
- Main stem can be moulded into position.

ABC/PLT2



Benches

Alto Bench

MFC:	Available in Ash, Autumn Cherry, Beech, Chester Oak, English Walnut, Grey, Grey Nebraska Oak, Laurentii Wenge, Natural Nebraska Oak and White
Nanotech:	Available in Black (2 Week Lead Time) - Undercut Edging detail option available (Contact Customer Services)
Veneer:	Available in Oak and Walnut (3 Week Lead Time)
Solid Wood:	Available in Oak (3 Week Lead Time) - Tops are 32mm thick
Edging:	Add surcharge for Wenge, Black and Plywood Effect per top - Edging on 25mm White MFC and Black Nanotech only
Metalwork:	Silver, Black Graphite and White - Add surcharge for Chrome Effect and Raw Add surcharge for Praline, Olive Green, Atlantic Blue, Sapphire Blue, Mustard Yellow, Terracotta and Conker Brown (2 Week Lead Time)



AB24/12

Alto High Bench with Support Frame

- Standard lead times. • 3 week lead time on Benches with Nanotech, Veneer and Solid Oak.
- 25mm MFC, Nanotech and Veneer top panels and 32mm Solid Oak top panels.
- Heavy duty 'A' frame legs with cross bracing frame.
- Benches with MFC, Nanotech and Veneer are supplied 1050h with radiused corners.
- Benches with Solid Oak are supplied 1057h with 90 degree corners.
- Available with undercut edging detail (contact customer services).

AB28/12 - 2800w x 1200d x 1050/1057h

AB26/12 - 2600w x 1200d x 1050/1057h

AB24/12 - 2400w x 1200d x 1050/1057h

AB22/12 - 2200w x 1200d x 1050/1057h



AB24/12/C

Alto High Bench with Support Frame and Castors

- Standard lead times. • 3 week lead time on Benches with Nanotech, Veneer and Solid Oak.
- 25mm MFC, Nanotech and Veneer top panels and 32mm Solid Oak top panels.
- Heavy duty 'A' frame legs with cross bracing frame. • 75mm grey rubber castors with brakes.
- Benches with MFC, Nanotech and Veneer are supplied 1050h with radiused corners.
- Benches with Solid Oak are supplied 1057h with 90 degree corners.
- Available with undercut edging detail (contact customer services).

AB28/12/C - 2800w x 1200d x 1050/1057h

AB26/12/C - 2600w x 1200d x 1050/1057h

AB24/12/C - 2400w x 1200d x 1050/1057h

AB22/12/C - 2200w x 1200d x 1050/1057h



ABL24/12

Alto Low Bench

- Standard lead times. • 3 week lead time on Benches with Nanotech, Veneer and Solid Oak.
- 25mm MFC, Nanotech and Veneer top panels and 32mm Solid Oak top panels.
- Heavy duty 'A' frame legs.
- Benches with MFC, Nanotech and Veneer are supplied 740h with radiused corners.
- Benches with Solid Oak are supplied 747h with 90 degree corners.
- Available with undercut edging detail (contact customer services).

ABL28/12 - 2800w x 1200d x 740/747h

ABL26/12 - 2600w x 1200d x 740/747h

ABL24/12 - 2400w x 1200d x 740/747h

ABL22/12 - 2200w x 1200d x 740/747h

ABL20/12 - 2000w x 1200d x 740/747h

ABL18/12 - 1800w x 1200d x 740/747h

ABL16/12 - 1600w x 1200d x 740/747h

ABL14/12 - 1400w x 1200d x 740/747h

ABL12/12 - 1200w x 1200d x 740/747h

ABL28/10 - 2800w x 1000d x 740/747h

ABL26/10 - 2600w x 1000d x 740/747h

ABL24/10 - 2400w x 1000d x 740/747h

ABL22/10 - 2200w x 1000d x 740/747h

ABL20/10 - 2000w x 1000d x 740/747h

ABL18/10 - 1800w x 1000d x 740/747h

ABL16/10 - 1600w x 1000d x 740/747h

ABL14/10 - 1400w x 1000d x 740/747h

ABL12/10 - 1200w x 1000d x 740/747h

Benches

Alto Bench

MFC:	Available in Ash, Autumn Cherry, Beech, Chester Oak, English Walnut, Grey, Grey Nebraska Oak, Laurentii Wenge, Natural Nebraska Oak and White
Nanotech:	Available in Black (2 Week Lead Time) - Undercut Edging detail option available (Contact Customer Services)
Veneer:	Available in Oak and Walnut (3 Week Lead Time)
Solid Wood:	Available in Oak (3 Week Lead Time) - Tops are 32mm thick
Edging:	Add surcharge for Wenge, Black and Plywood Effect per top - Edging on 25mm White MFC and Black Nanotech only
Metalwork:	Silver, Black Graphite and White - Add surcharge for Chrome Effect and Raw Add surcharge for Praline, Olive Green, Atlantic Blue, Sapphire Blue, Mustard Yellow, Terracotta and Conker Brown (2 Week Lead Time)



ABL24/12/C

Alto Low Bench with Castors

- Standard lead times. • 3 week lead time on Benches with Nanotech, Veneer and Solid Oak.
- 25mm MFC, Nanotech and Veneer top panels and 32mm Solid Oak top panels.
- Heavy duty 'A' frame legs. • 75mm grey rubber castors with brakes.
- Benches with MFC, Nanotech and Veneer are supplied 740h with radiused corners.
- Benches with Solid Oak are supplied 747h with 90 degree corners.
- Available with undercut edging detail (contact customer services).

ABL28/12/C - 2800w x 1200d x 740/747h

ABL26/12/C - 2600w x 1200d x 740/747h

ABL24/12/C - 2400w x 1200d x 740/747h

ABL22/12/C - 2200w x 1200d x 740/747h

ABL20/12/C - 2000w x 1200d x 740/747h

ABL18/12/C - 1800w x 1200d x 740/747h

ABL16/12/C - 1600w x 1200d x 740/747h

ABL14/12/C - 1400w x 1200d x 740/747h

ABL12/12/C - 1200w x 1200d x 740/747h

ABL28/10/C - 2800w x 1000d x 740/747h

ABL26/10/C - 2600w x 1000d x 740/747h

ABL24/10/C - 2400w x 1000d x 740/747h

ABL22/10/C - 2200w x 1000d x 740/747h

ABL20/10/C - 2000w x 1000d x 740/747h

ABL18/10/C - 1800w x 1000d x 740/747h

ABL16/10/C - 1600w x 1000d x 740/747h

ABL14/10/C - 1400w x 1000d x 740/747h

ABL12/10/C - 1200w x 1000d x 740/747h



Benches

Harmony Bench

MFC:	Available in Ash, Autumn Cherry, Beech, Chester Oak, English Walnut, Grey, Grey Nebraska Oak, Laurentii Wenge, Natural Nebraska Oak and White
Nanotech:	Available in Black (2 Week Lead Time)
Veneer:	Available in Oak and Walnut (3 Week Lead Time)
Solid Wood:	Available in Oak (3 Week Lead Time) - Tops are 32mm thick
Edging:	Add surcharge for Wenge, Black and Plywood Effect per top - Edging on 25mm White MFC and Black Nanotech only
Metalwork:	Silver, Black Graphite and White - Add surcharge for Chrome Effect and Raw Add surcharge for Praline, Olive Green, Atlantic Blue, Sapphire Blue, Mustard Yellow, Terracotta and Conker Brown (2 Week Lead Time)



HB20/9

Harmony Bench with Support Frame

- Standard lead times. • 3 week lead time on Benches with Nanotech, Veneer and Solid Oak.
- 25mm MFC, Nanotech and Veneer top panels and 32mm Solid Oak top panels.
- 'A' frame legs with cross bracing frame.
- Benches with MFC, Nanotech and Veneer are supplied 1050h with radiused corners.
- Benches with Solid Oak are supplied 1057h with 90 degree corners.

HB20/9 - 2000w x 900d x 1050/1057h



HB20/9/C

Harmony Bench with Support Frame and Castors

- Standard lead times. • 3 week lead time on Benches with Nanotech, Veneer and Solid Oak.
- 25mm MFC, Nanotech and Veneer top panels and 32mm Solid Oak top panels.
- 'A' frame legs with cross bracing frame. • 75mm grey rubber castors with brakes.
- Benches with MFC, Nanotech and Veneer are supplied 1050h with radiused corners.
- Benches with Solid Oak are supplied 1057h with 90 degree corners.

HB20/9/C - 2000w x 900d x 1050/1057h



HB16/9

Harmony Bench

- Standard lead times. • 3 week lead time on Benches with Nanotech, Veneer and Solid Oak.
- 'A' frame legs. • 25mm MFC, Nanotech and Veneer top panels and 32mm Solid Oak top panels.
- Benches with MFC, Nanotech and Veneer are supplied 1050h with radiused corners.
- Benches with Solid Oak are supplied 1057h with 90 degree corners.

HB18/9 - 1800w x 900d x 1050/1057h

HB16/9 - 1600w x 900d x 1050/1057h

HB14/9 - 1400w x 900d x 1050/1057h



HB16/9/C

Harmony Bench with Castors

- Standard lead times. • 3 week lead time on Benches with Nanotech, Veneer and Solid Oak.
- 'A' frame legs. • 25mm MFC, Nanotech and Veneer top panels and 32mm Solid Oak top panels.
- 75mm grey rubber castors with brakes.
- Benches with MFC, Nanotech and Veneer are supplied 1050h with radiused corners.
- Benches with Solid Oak are supplied 1057h with 90 degree corners.

HB18/9/C - 1800w x 900d x 1050/1057h

HB16/9/C - 1600w x 900d x 1050/1057h

HB14/9/C - 1400w x 900d x 1050/1057h

Benches

Loco Bench and Desk Mounted Flexible Return Screens

MFC:	Available in Ash, Autumn Cherry, Beech, Chester Oak, English Walnut, Grey, Grey Nebraska Oak, Laurentii Wenge, Natural Nebraska Oak and White
Nanotech:	Available in Black (2 Week Lead Time)
Veneer:	Available in Oak and Walnut (3 Week Lead Time)
Solid Wood:	Available in Oak (3 Week Lead Time) - Tops are 32mm thick
Edging:	Add surcharge for Wenge, Black and Plywood Effect per top - Edging on 25mm White MFC and Black Nanotech only
Metalwork:	Silver, Black Graphite and White - Add surcharge for Chrome Effect and Raw
Fabric:	Add surcharge for Praline, Olive Green, Atlantic Blue, Sapphire Blue, Mustard Yellow, Terracotta and Conker Brown (2 Week Lead Time) Fully upholstered with non-pinnable surface - See below for pricing groups



LB16/8

Loco Bench

- Standard lead times. • 3 week lead time on Benches with Nanotech, Veneer and Solid Oak.
- 'A' frame legs. • 25mm MFC, Nanotech and Veneer top panels and 32mm Solid Oak top panels.
- Benches with MFC, Nanotech and Veneer are supplied 740h with radiused corners.
- Benches with Solid Oak are supplied 747h with 90 degree corners.

- LB20/8** - 2000w x 800d x 740/747h
LB18/8 - 1800w x 800d x 740/747h
LB16/8 - 1600w x 800d x 740/747h
LB14/8 - 1400w x 800d x 740/747h



LB16/8/C

Loco Bench with Castors

- Standard lead times. • 3 week lead time on Benches with Nanotech, Veneer and Solid Oak.
- 'A' frame legs. • 25mm MFC, Nanotech and Veneer top panels and 32mm Solid Oak top panels.
- 75mm grey rubber castors with brakes.
- Benches with MFC, Nanotech and Veneer are supplied 740h with radiused corners.
- Benches with Solid Oak are supplied 747h with 90 degree corners.

- LB20/8/C** - 2000w x 800d x 740/747h
LB18/8/C - 1800w x 800d x 740/747h
LB16/8/C - 1600w x 800d x 740/747h
LB14/8/C - 1400w x 800d x 740/747h



ECSFR6F/D

Alto, Harmony and Loco Desk Mounted Flexible Return Contract Screen for Benches

- 2 week lead time. • Straight dividing screen with rounded corners.
- Screen slides onto the front of the desktop at desired position and can be moved at any time.
- Screens overhang the front of the desktop by 143mm.
- Use 2x screens to create full depth screen.

Straight Contract Screen

- ECSFR6F/D** - 743w x 36d x 375h
ECSFR5F/D - 643w x 36d x 375h

Fabric Groups: Group 1 - Add surcharge for Group 2-7



Straight Acoustic Screen



Fabric Finish



Benches

Loco Seat

MFC:	Available in Ash, Autumn Cherry, Beech, Chester Oak, English Walnut, Grey, Grey Nebraska Oak, Laurentii Wenge, Natural Nebraska Oak and White
Nanotech:	Available in Black (2 Week Lead Time)
Veneer:	Available in Oak and Walnut (3 Week Lead Time)
Solid Wood:	Available in Oak (3 Week Lead Time) - Tops are 32mm thick
Edging:	Add surcharge for Wenge, Black and Plywood Effect per top - Edging on 25mm White MFC and Black Nanotech only
Metalwork:	Silver, Black Graphite and White - Add surcharge for Chrome Effect and Raw
Fabric:	Add surcharge for Praline, Olive Green, Atlantic Blue, Sapphire Blue, Mustard Yellow, Terracotta and Conker Brown (2 Week Lead Time) Fully upholstered seat pads - See individual items for pricing groups



LBS15

Loco Seat

- Standard lead times. • 3 week lead time on Seats with Nanotech, Veneer and Solid Oak.
- 'A' frame legs. • 25mm MFC, Nanotech and Veneer seat panels and 32mm Solid Oak seat panels.
- Seats with MFC, Nanotech and Veneer are supplied 465h with radiused corners.
- Seats with Solid Oak are supplied 472h with 90 degree corners.

LBS19 - 1900w x 345d x 450/457h
LBS17 - 1700w x 345d x 450/457h
LBS15 - 1500w x 345d x 450/457h
LBS13 - 1300w x 345d x 450/457h



LBS15/FSP

Loco Seat with Full Length Seat Pad

- Standard lead times. • 3 week lead time on Seats with Nanotech, Veneer and Solid Oak.
- 'A' frame legs. • 25mm MFC, Nanotech and Veneer seat panels and 32mm Solid Oak seat panels.
- Full length seat pads for the Loco seat.
- Seats with MFC, Nanotech and Veneer are supplied 495h with radiused corners.
- Seats with Solid Oak are supplied 502h with 90 degree corners.

LBS19/FSP - 1900w x 345d x 520/527h
LBS17/FSP - 1700w x 345d x 520/527h
LBS15/FSP - 1500w x 345d x 520/527h
LBS13/FSP - 1300w x 345d x 520/527h

Fabric Groups: Group 1 - Add surcharge for Group 2-7



LBS15/ISP

Loco Seat with Individual Seat Pads

- Standard lead times. • 3 week lead time on Seats with Nanotech, Veneer and Solid Oak.
- 'A' frame legs. • 25mm MFC, Nanotech and Veneer seat panels and 32mm Solid Oak seat panels.
- Individual seat pads for the Loco seat.
- Seats with MFC, Nanotech and Veneer are supplied 495h with radiused corners.
- Seats with Solid Oak are supplied 502h with 90 degree corners.

LBS19/ISP - 1900w x 345d x 520/527h
LBS17/ISP - 1700w x 345d x 520/527h
LBS15/ISP - 1500w x 345d x 520/527h
LBS13/ISP - 1300w x 345d x 520/527h

Fabric Groups: Group 1 - Add surcharge for Group 2-7

Benches

Alto, Harmony and Loco Bench Accessories

Metalwork:

Silver, Black Graphite and White - Add surcharge for Chrome Effect and Raw
 Add surcharge for Praline, Olive Green, Atlantic Blue, Sapphire Blue, Mustard Yellow, Terracotta and Conker Brown (2 Week Lead Time)



HBCR

Bench Cable Riser

- Standard lead times. • Single channel cable riser.

- ABCR** - For 1050/1057h Alto Benches
- ABCR/C** - For 1050/1057h Alto Benches with Castors
- ABLCR** - For 740/747h Alto Benches
- ABLCR/C** - For 740/747h Alto Benches with Castors

- HBCR** - For Harmony Benches
- HBCR/C** - For Harmony Benches with Castors

- LBCR** - For Loco Benches
- LBCR/C** - For Loco Benches with Castors



HBCT16/9

Horizontal Cable Tray

- Standard lead times. • Cable trays are 100mm deep and 110mm high.
- Tray can be positioned to the users side of the workstation or towards the rear.

- ABCT28** - For 2800w Alto Benches - 2000w
- ABCT26** - For 2600w Alto Benches - 1800w
- ABCT24** - For 2400w Alto Benches - 1600w
- ABCT22** - For 2200w Alto Benches - 1400w
- ABCT20** - For 2000w Alto Benches - 1200w
- ABCT18** - For 1800w Alto Benches - 1000w
- ABCT16** - For 1600w Alto Benches - 800w
- ABCT14** - For 1400w Alto Benches - 600w
- ABCT12** - For 1200w Alto Benches - 400w

- HBCT20/9** - For HB20/9 - 1600w
- HBCT18/9** - For HB18/9 - 1400w
- HBCT16/9** - For HB16/9 - 1200w
- HBCT14/9** - For HB14/9 - 1000w



LBCT16

Horizontal Cable Tray

- Standard lead times. • High capacity cable management system neatly conceals power, data and telecom cables through a hinged cable management tray. • Cable trays are 130mm deep and 75mm high.

- LBCT20** - For LB20/8 - 1600w
- LBCT18** - For LB18/8 - 1400w
- LBCT16** - For LB16/8 - 1200w
- LBCT14** - For LB14/8 - 1000w

Benches

Cubeform Bench

MFC: Available in Ash, Autumn Cherry, Beech, Chester Oak, English Walnut, Grey, Grey Nebraska Oak, Laurentii Wenge, Natural Nebraska Oak and White
Nanotech: Available in Black (2 Week Lead Time)
Edging: Add surcharge for Wenge, Black and Plywood Effect per top - Edging on 25mm White MFC and Black Nanotech only
Metalwork: Silver, Black Graphite and White - Add surcharge for Chrome Effect and Raw
Add surcharge for Praline, Olive Green, Atlantic Blue, Sapphire Blue, Mustard Yellow, Terracotta and Conker Brown (2 Week Lead Time)



CF/RB16/8

Cubeform Rectangular Bench

- Standard lead times.
- 25mm top panel.
- Central support rail.

CF/RB16/8 - 1600w x 800d x 740h

CF/RB14/8 - 1400w x 800d x 740h

CF/RB12/8 - 1200w x 800d x 740h

CF/RB16/6 - 1600w x 600d x 740h

CF/RB14/6 - 1400w x 600d x 740h

CF/RB12/6 - 1200w x 600d x 740h



Benches

Cubeform Seat

MFC: Available in Ash, Autumn Cherry, Beech, Chester Oak, English Walnut, Grey, Grey Nebraska Oak, Laurentii Wenge, Natural Nebraska Oak and White
Nanotech: Available in Black (2 Week Lead Time)
Edging: Add surcharge for Wenge, Black and Plywood Effect per top - Edging on 25mm White MFC and Black Nanotech only
Metalwork: Silver, Black Graphite and White - Add surcharge for Chrome Effect and Raw
Add surcharge for Praline, Olive Green, Atlantic Blue, Sapphire Blue, Mustard Yellow, Terracotta and Conker Brown (2 Week Lead Time)
Fabric: Fully upholstered seat pads - See individual items for pricing groups



CF/RSS8

Cubeform Rectangular Single Seat

- Standard lead times.
- Complete with wooden seat or fully upholstered seat pad.
- Wooden seat with 25mm top panel.
- Seat pad priced in Group 1.

Cubeform Rectangular Single Wooden Seat

CF/RSS8 - 800w x 350d x 465h - Wooden Seat
CF/RSS5 - 475w x 350d x 465h - Wooden Seat

Cubeform Rectangular Single Fabric Seat

CF/RSS8/F - 800w x 350d x 530h - Seat Pad

Fabric Groups: Group 1 - Add surcharge for Group 2-7

CF/RSS5/F - 475w x 350d x 530h - Seat Pad

Fabric Groups: Group 1 - Add surcharge for Group 2-7



CF/RSS8/F



CF/RDS14

Cubeform Rectangular Bench Seat

- Standard lead times.
- Complete with wooden seat or fully upholstered seat pad.
- Wooden seat with 25mm top panel.
- Seat pad priced in Group 1.

Cubeform Rectangular Bench Wooden Seat

CF/RDS14 - 1400w x 350d x 465h - Wooden Seat
CF/RDS12 - 1200w x 350d x 465h - Wooden Seat
CF/RDS10 - 1000w x 350d x 465h - Wooden Seat

Cubeform Rectangular Bench Fabric Seat

CF/RDS14/F - 1400w x 350d x 530h - Seat Pad

Fabric Groups: Group 1 - Add surcharge for Group 2-7

CF/RDS12/F - 1200w x 350d x 530h - Seat Pad

Fabric Groups: Group 1 - Add surcharge for Group 2-7

CF/RDS10/F - 1000w x 350d x 530h - Seat Pad

Fabric Groups: Group 1 - Add surcharge for Group 2-7



CF/RDS14/F

Benches

Lux High Bench Tables

2 Week Lead Time

MFC:	Available in Ash, Autumn Cherry, Beech, Chester Oak, English Walnut, Grey, Grey Nebraska Oak, Laurentii Wenge, Natural Nebraska Oak and White
Nanotech:	Available in Black (2 Week Lead Time)
Veneer:	Available in Oak and Walnut (3 Week Lead Time)
Edging:	Add surcharge for Wenge, Black and Plywood Effect per top - Edging on 25mm White MFC and Black Nanotech only
Metalwork:	Silver, Black Graphite and White
Additional:	Standard corners (no suffix) - Add surcharge for radiused corners (suffix .../RC (page 186))



LUXHB32/12/ASL

Lux High Bench Table

- 2 week lead time.
- 2x 25mm top panels.
- Tapered legs with adjustable levelling feet and steel sub-frame.
- Available with radiused corners (see 'Additional' above).

LUXHB40/12...	- 2x Sections	- 4000w x 1200d x 1050h
LUXHB36/12...	- 2x Sections	- 3600w x 1200d x 1050h
LUXHB32/12...	- 2x Sections	- 3200w x 1200d x 1050h
LUXHB30/12...	- 2x Sections	- 3000w x 1200d x 1050h

LUXHB40/10...	- 2x Sections	- 4000w x 1000d x 1050h
LUXHB36/10...	- 2x Sections	- 3600w x 1000d x 1050h
LUXHB32/10...	- 2x Sections	- 3200w x 1000d x 1050h
LUXHB30/10...	- 2x Sections	- 3000w x 1000d x 1050h

Finishes:

Ash (.../ASL) Legs

Add surcharge for Stained Walnut (.../WAL), Stained Espresso (.../ESL), Stained Wenge (.../WEL), Stained Grey (.../GYL), Stained Black (.../BKL) and White (.../WHL) Legs



Benches

Lux High Bench Tables

2 Week Lead Time

MFC:	Available in Ash, Autumn Cherry, Beech, Chester Oak, English Walnut, Grey, Grey Nebraska Oak, Laurentii Wenge, Natural Nebraska Oak and White
Nanotech:	Available in Black (2 Week Lead Time)
Veneer:	Available in Oak and Walnut (3 Week Lead Time)
Edging:	Add surcharge for Wenge, Black and Plywood Effect per top - Edging on 25mm White MFC and Black Nanotech only
Metalwork:	Silver, Black Graphite and White
Additional:	Standard corners (no suffix) - Add surcharge for radiused corners (suffix .../RC (see below))



LUXHB16/12/ASL

Lux High Bench Table

- 2 week lead time. • 25mm top panel.
- Tapered legs with adjustable levelling feet and steel sub-frame.
- Available with radiused corners, suffix .../RC (see below).

LUXHB24/12...	- 1x Section - 2400w x 1200d x 1050h
LUXHB22/12...	- 1x Section - 2200w x 1200d x 1050h
LUXHB20/12...	- 1x Section - 2000w x 1200d x 1050h
LUXHB18/12...	- 1x Section - 1800w x 1200d x 1050h
LUXHB16/12...	- 1x Section - 1600w x 1200d x 1050h
LUXHB14/12...	- 1x Section - 1400w x 1200d x 1050h

LUXHB24/10...	- 1x Section - 2400w x 1000d x 1050h
LUXHB22/10...	- 1x Section - 2200w x 1000d x 1050h
LUXHB20/10...	- 1x Section - 2000w x 1000d x 1050h
LUXHB18/10...	- 1x Section - 1800w x 1000d x 1050h
LUXHB16/10...	- 1x Section - 1600w x 1000d x 1050h
LUXHB14/10...	- 1x Section - 1400w x 1000d x 1050h

Finishes: Ash (.../ASL) Legs
 Add surcharge for Stained Walnut (.../WAL), Stained Espresso (.../ESL), Stained Wenge (.../WEL), Stained Grey (.../GYL), Stained Black (.../BKL) and White (.../WHL) Legs



LUXHB32/12/ASL/RC

Lux Optional Radiused Corners

- 2 week lead time. • Adds a radius to 4 corners of specific Lux tables.
- Suffix .../RC to the end of relevant Lux codes.

.../RC - Radiused Corners



LUXHB16/12/ASL/RC



LCTR16
 Illustrated in red

Lux Cable Tray

- 2 week lead time. • Compatible with all Lux tables.
- High capacity cable management system neatly conceals power, data and telecom cables through a hinged cable management tray. • Cable trays are 180mm deep and 80mm high.

LCTR40	- For 4000w Rectangular and High Bench Tables - 1500w (2x)
LCTR36	- For 3600w Rectangular and High Bench Tables - 1300w (2x)
LCTR32	- For 3200w Rectangular and High Bench Tables - 1100w (2x)
LCTR30	- For 3000w Rectangular and High Bench Tables - 1000w (2x)
LCTR24	- For 2400w Rectangular and High Bench Tables - 900w (2x)
LCTR22	- For 2200w Rectangular and High Bench Tables - 800w (2x)
LCTR20	- For 2000w Rectangular and High Bench Tables - 1500w
LCTR18	- For 1800w Rectangular and High Bench Tables - 1300w
LCTR16	- For 1600w Rectangular and High Bench Tables - 1100w
LCTR14	- For 1400w Rectangular and High Bench Tables - 900w

Benches

Forte Bench

2 Week Lead Time

MFC: Available in Ash, Autumn Cherry, Beech, Chester Oak, English Walnut, Grey, Grey Nebraska Oak, Laurentii Wenge, Natural Nebraska Oak and White
Nanotech: Available in Black (2 Week Lead Time) - Nanotech on 25mm Desktops only
Veneer: Available in Oak and Walnut (3 Week Lead Time)
Edging: Add surcharge for Wenge, Black and Plywood Effect per top - Edging on 25mm White MFC and Black Nanotech only
Metalwork: Silver



FORHB20/9

Forte High Bench Table

- 2 week lead time.
- 25mm top panel.
- Panel ended benches.
- Horizontal Cable tray included.
- Vertical cable management access within each panel end via a 80mm cable port.

FORHB22/10 - 2200w x 1000d x 1050h

FORHB20/10 - 2000w x 1000d x 1050h

FORHB18/10 - 1800w x 1000d x 1050h

FORHB16/10 - 1600w x 1000d x 1050h

FORHB22/9 - 2200w x 900d x 1050h

FORHB20/9 - 2000w x 900d x 1050h

FORHB18/9 - 1800w x 900d x 1050h

FORHB16/9 - 1600w x 900d x 1050h

Additional: For Contrasting Edge Finishes, see **Contrasting Finish** section on **page 188**
Further information required, contact Customer Services for specification form



FORB20/9

Forte Bench Table

- 2 week lead time.
- 25mm top panel.
- Panel ended benches.
- Horizontal Cable tray included.
- Vertical cable management access within each panel end via a 80mm cable port.

FORB22/10 - 2200w x 1000d x 740h

FORB20/10 - 2000w x 1000d x 740h

FORB18/10 - 1800w x 1000d x 740h

FORB16/10 - 1600w x 1000d x 740h

FORB22/9 - 2200w x 900d x 740h

FORB20/9 - 2000w x 900d x 740h

FORB18/9 - 1800w x 900d x 740h

FORB16/9 - 1600w x 900d x 740h

Additional: For Contrasting Edge Finishes, see **Contrasting Finish** section on **page 188**
Further information required, contact Customer Services for specification form



Benches

Forte Bench Accessories and Compatibility Breakdown

2 Week Lead Time

MFC: Available in Ash, Autumn Cherry, Beech, Chester Oak, English Walnut, Grey, Grey Nebraska Oak, Laurentii Wenge, Natural Nebraska Oak and White
Nanotech: Available in Black (2 Week Lead Time) - *Nanotech on 25mm Desktops only*
Veneer: Available in Oak and Walnut (3 Week Lead Time)
Edging: Add surcharge for Wenge, Black and Plywood Effect per top - *Edging on 25mm White MFC and Black Nanotech only*
Metalwork: Silver

Contrasting Finish

- Standard Top Panel Edge Detail applied as normal.
- Contrasting Finish to be chosen from Standard Dual Board MFC Finishes only.
- To apply a contrasting finish from the Desktop Surface (A) to the Leg (C), add **surcharge** and suffix **.../CONAC** to your chosen unit, and submit a Forte Specification Form.
- To apply a contrasting finish from the Legs Main Surface (C) to its Edge (D), add **surcharge** and suffix **.../CONCD** to your chosen unit, and submit a Forte Specification Form.
- To apply a contrasting finish from the Desktop Surface (A) to the Leg (C), and from the Legs Main Surface (C) to its Edge (D), add **surcharge** and suffix **.../CONACD** to your chosen unit, and submit a Forte Specification Form.

- .../CONAC** - 'A' contrasting to 'C'
.../CONCD - 'C' contrasting to 'D'
.../CONACD - 'A' contrasting to 'C' and 'C' contrasting to 'D'

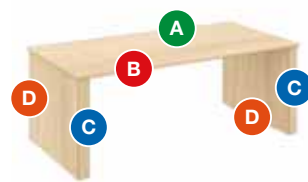

- **A Desktop Surface**
- **B Desktop Edge**
- **C Leg Main Surface**
- **D Leg Main Edge**

Benches Compatibility Breakdown

- **Black** - Compatible
- **Blue** - Conflict when using screens without .../V
- **Red** - May not support larger modules

	Power and Data Modules															
	Kaspa, page 294	Prime, page 294	Boardroom, page 295	Conus, page 296	Peak, page 297	Escalate, page 297	Wireless Charging Unit, page 298	Port Hole, page 299	Pix, page 299	Pluto, page 300	Inca, page 300	Flex, page 301	Boost, page 301	Capsule, page 302	Plaza, page 303	Wieland Socket Boxes, page 303
Benches - Alto Canopy	●	●	●	●	●	●	●	●	●	●	●	●	●	●	●	●
Benches - Alto 2200w	●	●	●	●	●	●	●	●	●	●	●	●	●	●	●	●
Benches - Alto 1200w	●	●	●	●	●	●	●	●	●	●	●	●	●	●	●	●
Benches - All other Alto	●	●	●	●	●	●	●	●	●	●	●	●	●	●	●	●
Benches - Harmony 2000w	●	●	●	●	●	●	●	●	●	●	●	●	●	●	●	●
Benches - All other Harmony	●	●	●	●	●	●	●	●	●	●	●	●	●	●	●	●
Benches - Loco	●	●	●	●	●	●	●	●	●	●	●	●	●	●	●	●
Benches - Cubeform	●	●	●	●	●	●	●	●	●	●	●	●	●	●	●	●
Benches - Forte	●	●	●	●	●	●	●	●	●	●	●	●	●	●	●	●
Benches - Lux	●	●	●	●	●	●	●	●	●	●	●	●	●	●	●	●

Modular Tables

Modular Meeting, Bar and Coffee Tables and Meeting Additions



Collaboration and agile working environments are an important aspect of the modern workspace, where flexible ways of working drive business requirements. Elite's modular table portfolio provides flexible solutions with modular flip-top tables for transient meeting spaces. A wide range of coffee tables, varying in style, has been designed to complement Elite's breakout seating creating a more cohesive environment.



Modular Tables

Tilt Fliptop Tables

MFC: Available in Ash, Autumn Cherry, Beech, Chester Oak, English Walnut, Grey, Grey Nebraska Oak, Laurentii Wenge, Natural Nebraska Oak and White
Nanotech: Available in Black (2 Week Lead Time)
Veneer: Available in Oak and Walnut (3 Week Lead Time)
Edging: Add surcharge for Wenge, Black and Plywood Effect per top - Edging on 25mm White MFC and Black Nanotech only
Metalwork: Silver, Black Graphite and White - Add surcharge for Raw
 Add surcharge for Praline, Olive Green, Atlantic Blue, Sapphire Blue, Mustard Yellow, Terracotta and Conker Brown (2 Week Lead Time)



TIL18/7

Tilt Fliptop Rectangular Table

- 2 week lead time.
- 25mm top panel.
- Chevron leg frame.
- Folds via quick release lever.
- Enables horizontal nesting of frames.

TIL18/7 - 1800w x 750d x 755h

TIL15/7 - 1500w x 750d x 755h

TIL12/7 - 1200w x 750d x 755h

TIL18/6 - 1800w x 600d x 755h

TIL15/6 - 1500w x 600d x 755h

TIL12/6 - 1200w x 600d x 755h



TIL18/7



3x TIL18/7



TIL/MP18

Tilt Fliptop Modesty Panel Option

- 2 week lead time.
- Can be retro-fitted.
- Folds into vertical position when the release lever is activated.

TIL/MP18 - 1400w x 300h

TIL/MP15 - 1100w x 300h

TIL/MP12 - 800w x 300h



FTLP

Fliptop Table Top Connector

- Standard lead time.
- Table tops are pre-drilled for ease of fitting.
- The red markers below indicate the pre-drilled positions on the above tables.

FTLP

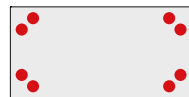

750d

Rectangular Table



600d

Rectangular Table



TTC1

Tilt Table Top Connector

- Standard lead time.
- Table tops are pre-drilled for ease of fitting.
- The red markers below indicate the pre-drilled positions on the above tables.

TTC1



750d

Rectangular Table



600d

Rectangular Table

Modular Tables

Fliptop Tables

MFC: Available in Ash, Autumn Cherry, Beech, Chester Oak, English Walnut, Grey, Grey Nebraska Oak, Laurentii Wenge, Natural Nebraska Oak and White
Nanotech: Available in Black (2 Week Lead Time)
Veneer: Available in Oak and Walnut (3 Week Lead Time)
Edging: Add surcharge for Wenge, Black and Plywood Effect per top - Edging on 25mm White MFC and Black Nanotech only
Metalwork: Silver



FTT16

Fliptop Rectangular Table

- Standard lead time.
- 25mm top panel.
- Silver tubular upright and cross frame.
- Brushed aluminium support feet.
- Heavy duty release and flip mechanism.
- 2x lockable castors.
- Available in Silver RAL 9006 only.

FTT16 - 1600w x 800d x 740h

FTT14 - 1400w x 800d x 740h

FTT12 - 1200w x 800d x 740



FTT16SC

Fliptop Semi-circular Table

- Standard lead time.
- 25mm top panel.
- Silver tubular upright and cross frame.
- Brushed aluminium support feet.
- Heavy duty release and flip mechanism.
- 2x lockable castors.
- Available in Silver RAL 9006 only.

FTT16SC - 1600w (dia) x 800d x 740h



FTLP

Fliptop Table Top Connector

- 2 week lead time.
- Table tops are pre-drilled for ease of fitting.
- The red markers below indicate the pre-drilled positions on the above tables.

FTLP

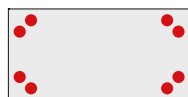

Rectangular Table



Semi-circular Table

Modular Tables

Folding and Training Tables

MFC: Available in Ash, Autumn Cherry, Beech, Chester Oak, English Walnut, Grey, Grey Nebraska Oak, Laurentii Wenge, Natural Nebraska Oak and White
Nanotech: Available in Black (2 Week Lead Time)
Veneer: Available in Oak and Walnut (3 Week Lead Time)
Edging: Add surcharge for Wenge, Black and Plywood Effect per top - Edging on 25mm White MFC and Black Nanotech only
Metalwork: **Folding:** Silver
Training: Silver, Black Graphite and White - Add surcharge for Chrome Effect and Raw
 Add surcharge for Praline, Olive Green, Atlantic Blue, Sapphire Blue, Mustard Yellow, Terracotta and Conker Brown (2 Week Lead Time)



FT16

Folding Rectangular Table

- Standard lead time. • 25mm top panel. • 30mm diameter leg frames. • Folded height 130mm.
- Adjustable feet for levelling purposes. • Available in Silver RAL 9006 only.

- FT18** - Straight Leg - 1800w x 800d x 735h
FT16 - Straight Leg - 1600w x 800d x 735h
FT14 - Straight Leg - 1400w x 800d x 735h
FT12 - Straight Leg - 1200w x 800d x 735h



TR16



Circular Leg

Rectangular Training Table

- Standard lead time. • 25mm top panel. • Welded underframe on 40mm diameter tubular legs.
- Adjustable feet for levelling purposes.

- TR18** - 1800w x 800d x 740h (Space between legs: 1682w and 682d)
TR16 - 1600w x 800d x 740h (Space between legs: 1482w and 682d)
TR14 - 1400w x 800d x 740h (Space between legs: 1282w and 682d)
TR12 - 1200w x 800d x 740h (Space between legs: 1082w and 682d)
TR10 - 1000w x 800d x 740h (Space between legs: 882w and 682d)
TR08 - 800w x 800d x 740h (Space between legs: 682w and 682d)

- TR18/6** - 1800w x 600d x 740h (Space between legs: 1682w and 482d)
TR16/6 - 1600w x 600d x 740h (Space between legs: 1482w and 482d)
TR14/6 - 1400w x 600d x 740h (Space between legs: 1282w and 482d)
TR12/6 - 1200w x 600d x 740h (Space between legs: 1082w and 482d)
TR10/6 - 1000w x 600d x 740h (Space between legs: 882w and 482d)
TR08/6 - 800w x 600d x 740h (Space between legs: 682w and 482d)



TSC16



Circular Leg

Semi-circular Training Table

- Standard lead time. • 25mm top panel. • Welded underframe on 40mm diameter tubular legs.
- Adjustable feet for levelling purposes.

- TSC16** - 1600w x 800d x 740h (Space between legs: 1477w, 782w and 654d)



TT16



Circular Leg

Trapezoidal Training Table

- Standard lead time. • 25mm top panel. • Welded underframe on 40mm diameter tubular legs.
- Angled ends are 800mm wide. • Adjustable feet for levelling purposes.

- TT16** - 1600w x 690d x 740h (Space between legs: 1477w, 782w and 654d)
TT14 - 1400w x 690d x 740h (Space between legs: 1277w, 782w and 654d)

Modular Tables

Training Tables

MFC: Available in Ash, Autumn Cherry, Beech, Chester Oak, English Walnut, Grey, Grey Nebraska Oak, Laurentii Wenge, Natural Nebraska Oak and White
Nanotech: Available in Black (2 Week Lead Time)
Veneer: Available in Oak and Walnut (3 Week Lead Time)
Edging: Add surcharge for Wenge, Black and Plywood Effect per top - Edging on 25mm White MFC and Black Nanotech only
Metalwork: Silver, Black Graphite and White - Add surcharge for Chrome Effect and Raw
 Add surcharge for Praline, Olive Green, Atlantic Blue, Sapphire Blue, Mustard Yellow, Terracotta and Conker Brown (2 Week Lead Time)



TR16

 Square Leg

Rectangular Training Table with Square Legs

- Standard lead time.
- 25mm top panel.
- Welded underframe on 35mm x 35mm square legs.
- Adjustable feet for levelling purposes.

- TRSQ18** - 1800w x 800d x 740h (Space between legs: 1685w and 682d)
TRSQ16 - 1600w x 800d x 740h (Space between legs: 1485w and 682d)
TRSQ14 - 1400w x 800d x 740h (Space between legs: 1285w and 682d)
TRSQ12 - 1200w x 800d x 740h (Space between legs: 1085w and 682d)
TRSQ10 - 1000w x 800d x 740h (Space between legs: 885w and 682d)
TRSQ08 - 800w x 800d x 740h (Space between legs: 685w and 682d)

- TRSQ18/6** - 1800w x 600d x 740h (Space between legs: 1685w and 482d)
TRSQ16/6 - 1600w x 600d x 740h (Space between legs: 1485w and 482d)
TRSQ14/6 - 1400w x 600d x 740h (Space between legs: 1285w and 482d)
TRSQ12/6 - 1200w x 600d x 740h (Space between legs: 1085w and 482d)
TRSQ10/6 - 1000w x 600d x 740h (Space between legs: 885w and 482d)
TRSQ08/6 - 800w x 600d x 740h (Space between legs: 685w and 482d)



TSC16

 Square Leg

Semi-circular Training Table with Square Legs

- Standard lead time.
- 25mm top panel.
- Welded underframe on 35mm x 35mm square legs.
- Adjustable feet for levelling purposes.

- TSCSQ16** - 1600w x 800d x 740h (Space between legs: 1480w, 785w and 657d)



TT16

 Square Leg

Trapezoidal Training Table with Square Legs

- Standard lead time.
- 25mm top panel.
- Welded underframe on 35mm x 35mm square legs.
- Angled ends are 800mm wide.
- Adjustable feet for levelling purposes.

- TTSQ16** - 1600w x 690d x 740h (Space between legs: 1480w, 785w and 657d)
TTSQ14 - 1400w x 690d x 740h (Space between legs: 1280w, 785w and 657d)



Modular Tables

Vista Tables

MFC:	Available in Ash, Autumn Cherry, Beech, Chester Oak, English Walnut, Grey, Grey Nebraska Oak, Laurentii Wenge, Natural Nebraska Oak and White
Nanotech:	Available in Black (2 Week Lead Time)
Veneer:	Available in Oak and Walnut (3 Week Lead Time)
Edging:	Add surcharge for Wenge, Black and Plywood Effect per top - Edging on 25mm White MFC and Black Nanotech only
Metalwork:	Brushed Aluminium



VISR16/8

Vista Rectangular Training Table

- Standard lead time. • 25mm top panel.
- Brushed aluminium chevron leg frames supported by black steel subframe.
- Adjustable feet for levelling purposes.

VISR18/9 - 1800w x 900d x 750h

VISR16/9 - 1600w x 900d x 750h

VISR14/9 - 1400w x 900d x 750h

VISR12/9 - 1200w x 900d x 750h

VISR18/8 - 1800w x 800d x 750h

VISR16/8 - 1600w x 800d x 750h

VISR14/8 - 1400w x 800d x 750h

VISR12/8 - 1200w x 800d x 750h

VISR18/7 - 1800w x 700d x 750h

VISR16/7 - 1600w x 700d x 750h

VISR14/7 - 1400w x 700d x 750h

VISR12/7 - 1200w x 700d x 750h



Modular Tables

Piazza Tables

MDF: Available in White with undercut edge



PIA/REC16/09/ASL

Piazza Rectangular Meeting Table

- 3 week lead time.
- 30mm top panel.
- Solid ash square legs with protective glides.
- White epoxy powder coated leg plates.

PIA/REC16/09... - 1600w x 900d x 725h

Finishes: Ash (.../ASL) Legs
Add surcharge for Stained Walnut (.../WAL), Stained Espresso (.../ESL), Stained Wenge (.../WEL), Stained Grey (.../GYL), Stained Black (.../BKL) and White (.../WHL) Legs



PIA/SQR09/ASL

Piazza Square Meeting Table

- 3 week lead time.
- 30mm top panel.
- Solid ash square legs with protective glides.
- White epoxy powder coated leg plates.

PIA/SQR09... - 900w x 900d x 725h

Finishes: Ash (.../ASL) Legs
Add surcharge for Stained Walnut (.../WAL), Stained Espresso (.../ESL), Stained Wenge (.../WEL), Stained Grey (.../GYL), Stained Black (.../BKL) and White (.../WHL) Legs



PIA/CIR10/ASL

Piazza Circular Meeting Table

- 3 week lead time.
- 30mm top panel.
- Solid ash square legs with protective glides.
- White epoxy powder coated leg plates.

PIA/CIR12... - 1200w (dia) x 725h

PIA/CIR10... - 1000w (dia) x 725h

PIA/CIR08... - 800w (dia) x 725h

Finishes: Ash (.../ASL) Legs
Add surcharge for Stained Walnut (.../WAL), Stained Espresso (.../ESL), Stained Wenge (.../WEL), Stained Grey (.../GYL), Stained Black (.../BKL) and White (.../WHL) Legs



Modular Tables

Tondo Tables

MDF: Available in White with undercut edge



TON/REC16/09/BEL

Tondo Rectangular Meeting Table

- 3 week lead time.
- 30mm top panel.
- Solid beech round legs with protective glides.
- White epoxy powder coated leg plates.

TON/REC16/09... - 1600w x 900d x 720h

Finishes: Beech (.../BEL) Legs
Add surcharge for Stained Walnut (.../WAL), Stained Espresso (.../ESL), Stained Wenge (.../WEL), Stained Grey (.../GYL), Stained Black (.../BKL) and White (.../WHL) Legs



TON/SQR09/BEL

Tondo Square Meeting Table

- 3 week lead time.
- 30mm top panel.
- Solid beech round legs with protective glides.
- White epoxy powder coated leg plates.

TON/SQR09... - 900w x 900d x 720h

Finishes: Beech (.../BEL) Legs
Add surcharge for Stained Walnut (.../WAL), Stained Espresso (.../ESL), Stained Wenge (.../WEL), Stained Grey (.../GYL), Stained Black (.../BKL) and White (.../WHL) Legs



TON/CIR10/BEL

Tondo Circular Meeting Table

- 3 week lead time.
- 30mm top panel.
- Solid beech round legs with protective glides.
- White epoxy powder coated leg plates.

TON/CIR12... - 1200w (dia) x 720h

TON/CIR10... - 1000w (dia) x 720h

TON/CIR08... - 800w (dia) x 720h

Finishes: Beech (.../BEL) Legs
Add surcharge for Stained Walnut (.../WAL), Stained Espresso (.../ESL), Stained Wenge (.../WEL), Stained Grey (.../GYL), Stained Black (.../BKL) and White (.../WHL) Legs



Modular Tables

Meeting Tables

MFC: Available in Ash, Autumn Cherry, Beech, Chester Oak, English Walnut, Grey, Grey Nebraska Oak, Laurentii Wenge, Natural Nebraska Oak and White
Nanotech: Available in Black (2 Week Lead Time)
Veneer: Available in Oak and Walnut (3 Week Lead Time)
Edging: Add surcharge for Wenge, Black and Plywood Effect per top - Edging on 25mm White MFC and Black Nanotech only
Metalwork: **MT01..., MT02... and MT03...:** Silver, Black Graphite and White
 Add surcharge for Praline, Olive Green, Atlantic Blue, Sapphire Blue, Mustard Yellow, Terracotta and Conker Brown (2 Week Lead Time)



MT01/SQR08

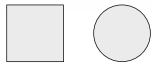

Square and Circular Top

Square / Circular Meeting Table

- Standard lead time. • 25mm top panel. • Wire managed base, 80mm aperture, located within the column.
- 100mm square column. • Heavy duty weighted 505mm square x 15mm deep base.
- Levelling feet.

MT01/SQR10 - Square Top - 1000w x 1000d x 740h

MT01/SQR08 - Square Top - 800w x 800d x 740h

MT01/CIR12 - Circular Top - 1200w (dia) x 740h

MT01/CIR10 - Circular Top - 1000w (dia) x 740h

MT01/CIR08 - Circular Top - 800w (dia) x 740h



MT01/SQR08

Square / Circular Meeting Table

- Standard lead time. • 25mm top panel. • 80mm diameter column.
- 500mm square x 5mm deep base.

MT02/SQR08 - Square Top - 800w x 800d x 740h

MT02/SQR06 - Square Top - 600w x 600d x 740h

MT02/CIR10 - Circular Top - 1000w (dia) x 740h

MT02/CIR08 - Circular Top - 800w (dia) x 740h

MT02/CIR06 - Circular Top - 600w (dia) x 740h



MT02/SQR08



Square and Circular Top

Square / Circular Meeting Table

- Standard lead time. • 25mm top panel. • 80mm diameter column.
- 600mm diameter x 5mm deep base.

MT03/SQR08 - Square Top - 800w x 800d x 740h

MT03/SQR06 - Square Top - 600w x 600d x 740h

MT03/CIR10 - Circular Top - 1000w (dia) x 740h

MT03/CIR08 - Circular Top - 800w (dia) x 740h

MT03/CIR06 - Circular Top - 600w (dia) x 740h



MT03/CIR10



Square and Circular Top

Modular Tables

Meeting Tables

MFC: Available in Ash, Autumn Cherry, Beech, Chester Oak, English Walnut, Grey, Grey Nebraska Oak, Laurentii Wenge, Natural Nebraska Oak and White
Nanotech: Available in Black (2 Week Lead Time)
Veneer: Available in Oak and Walnut (3 Week Lead Time)
Edging: Add surcharge for Wenge, Black and Plywood Effect per top - Edging on 25mm White MFC and Black Nanotech only
Metalwork: **MT04..., MT06... and MT07...:** Silver, Black Graphite and White
 Add surcharge for Praline, Olive Green, Atlantic Blue, Sapphire Blue, Mustard Yellow, Terracotta and Conker Brown (2 Week Lead Time)
MT05...: Chrome



MT04/CIR10



Square and Circular Top

Square / Circular Meeting Table

- Standard lead time. • 25mm top panel. • 120mm diameter column.
- Heavy duty weighted 685mm diameter domed base with rolled edge.

MT04/SQR10 - Square Top - 1000w x 1000d x 740h

MT04/SQR08 - Square Top - 800w x 800d x 740h

MT04/CIR12 - Circular Top - 1200w (dia) x 740h

MT04/CIR10 - Circular Top - 1000w (dia) x 740h

MT04/CIR08 - Circular Top - 800w (dia) x 740h



MT05/CIR10

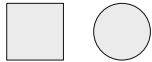

Square and Circular Top

Square / Circular Chrome Trumpet Based Meeting Table

- Standard lead time. • 25mm top panel. • 60mm diameter column.
- Weighted 490mm diameter trumpet base. • Protective feet.
- Available in Chrome only.

MT05/SQR08 - Square Top - 800w x 800d x 725h

MT05/SQR06 - Square Top - 600w x 600d x 725h

MT05/CIR10 - Circular Top - 1000w (dia) x 725h

MT05/CIR08 - Circular Top - 800w (dia) x 725h

MT05/CIR06 - Circular Top - 600w (dia) x 725h



MT06/SQR08



Square and Circular Top

Square / Circular Pyramid Based Meeting Table

- Standard lead time. • 25mm top panel. • 60mm diameter column.
- 490mm square x 8mm deep pyramid base. • Levelling feet.

MT06/SQR08 - Square Top - 800w x 800d x 725h

MT06/SQR06 - Square Top - 600w x 600d x 725h

MT06/CIR10 - Circular Top - 1000w (dia) x 725h

MT06/CIR08 - Circular Top - 800w (dia) x 725h

MT06/CIR06 - Circular Top - 600w (dia) x 725h



MT07/CIR10



Square and Circular Top

Square / Circular Meeting Table

- Standard lead time. • 25mm top panel. • 60mm diameter column.
- Weighted 470mm diameter x 5mm deep base. • Protective feet.

MT07/SQR08 - Square Top - 800w x 800d x 725h

MT07/SQR06 - Square Top - 600w x 600d x 725h

MT07/CIR10 - Circular Top - 1000w (dia) x 725h

MT07/CIR08 - Circular Top - 800w (dia) x 725h

MT07/CIR06 - Circular Top - 600w (dia) x 725h

Modular Tables

Meeting Tables

MFC: Available in Ash, Autumn Cherry, Beech, Chester Oak, English Walnut, Grey, Grey Nebraska Oak, Laurentii Wenge, Natural Nebraska Oak and White
Nanotech: Available in Black (2 Week Lead Time)
Veneer: Available in Oak and Walnut (3 Week Lead Time)
Edging: Add surcharge for Wenge, Black and Plywood Effect per top - Edging on 25mm White MFC and Black Nanotech only
Metalwork: **MT09HA... and MT10HA...:** Silver and White



MT09/CIR10



Circular Top

Circular Sit / Stand Meeting Table

- Standard lead time.
- 25mm top panel.
- 725mm-1050mm height adjustment.
- 95mm diameter gas lift column.
- Heavy duty weighted 675mm diameter domed base with rolled edge.
- Available in Silver RAL 9006 or White RAL 9003 only.

MT09HA/CIR12... - Circular Top - 1200w (dia) x 725-1050h

MT09HA/CIR10... - Circular Top - 1000w (dia) x 725-1050h

Finishes: Silver (no suffix) and White (.../W)



MT10/CIR10



Circular Top

Circular Mobile Sit / Stand Meeting Table

- Standard lead time.
- 25mm top panel.
- 725mm-1050mm height adjustment.
- 95mm diameter gas lift column.
- Mobile 920mm diameter four-legged base with locking castors.
- Available in Silver RAL 9006 or White RAL 9003 only.

MT10HA/CIR12... - Circular Top - 1200w (dia) x 725-1050h

MT10HA/CIR10... - Circular Top - 1000w (dia) x 725-1050h

Finishes: Silver (no suffix) and White (.../W)



Modular Tables

Meeting Tables

MFC: Available in Ash, Autumn Cherry, Beech, Chester Oak, English Walnut, Grey, Grey Nebraska Oak, Laurentii Wenge, Natural Nebraska Oak and White
Nanotech: Available in Black (2 Week Lead Time)
Veneer: Available in Oak and Walnut (3 Week Lead Time)
Edging: Add surcharge for Wenge, Black and Plywood Effect per top - Edging on 25mm White MFC and Black Nanotech only
Metalwork: **MT11... and MT12...:** Chrome
CTB...: Polished Base - Add surcharge for Black Base
MT13...: Silver, Black Graphite and White
 Add surcharge for Praline, Olive Green, Atlantic Blue, Sapphire Blue, Mustard Yellow, Terracotta and Conker Brown (2 Week Lead Time)



MT11/SQR10

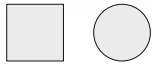

Square and Circular Top

Square / Circular Meeting Table for Cascara and Myla

- Standard lead time.
- 25mm top panel.
- 50mm diameter column.
- 655mm four-star base.
- Available in Chrome only.
- Complements Cascara and Myla seating range (See the Elite Seating Guide).

MT11/SQR10 - Square Top - 1000w x 1000d x 725h
MT11/SQR08 - Square Top - 800w x 800d x 725h

MT11/CIR10 - Circular Top - 1000w (dia) x 725h
MT11/CIR08 - Circular Top - 800w (dia) x 725h



CTB/SQR10/7



Square and Circular Top

Canterbury Square / Circular Meeting Table

- Standard lead time.
- 25mm top panel.
- Polished or black aluminium four-star base.
- Complements Tempo, Elipsa, Cascara, Myla and Luma seating ranges (See the Elite Seating Guide).

CTB/SQR10/7... - Square Top - 1000w x 1000d x 750h
CTB/SQR08/7... - Square Top - 800w x 800d x 750h

CTB/CIR10/7... - Circular Top - 1000w (dia) x 750h
CTB/CIR08/7... - Circular Top - 800w (dia) x 750h

Finishes: Polished Base (.../P4S)
 Add surcharge for a Black Base (.../B4S)



MT12/CIR10

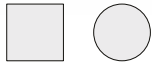

Square and Circular Top

Square / Circular Meeting Table

- Standard lead time.
- 25mm top panel.
- 50mm diameter column.
- 680mm four-star base.
- Levelling feet.
- Available in Chrome only.

MT12/SQR10 - Square Top - 1000w x 1000d x 725h
MT12/SQR08 - Square Top - 800w x 800d x 725h

MT12/CIR10 - Circular Top - 1000w (dia) x 725h
MT12/CIR08 - Circular Top - 800w (dia) x 725h



MT13/CIR15



Square and Circular Top

Circular Meeting Table

- Standard lead time.
- 25mm top panel.
- 60mm diameter post legs.
- Fully welded four-legged frame.
- Levelling feet.

MT13/CIR15 - Circular Top - 1500w (dia) x 725h

Modular Tables

Bar Tables

MFC: Available in Ash, Autumn Cherry, Beech, Chester Oak, English Walnut, Grey, Grey Nebraska Oak, Laurentii Wenge, Natural Nebraska Oak and White
Nanotech: Available in Black (2 Week Lead Time)
Veneer: Available in Oak and Walnut (3 Week Lead Time)
Edging: Add surcharge for Wenge, Black and Plywood Effect per top - Edging on 25mm White MFC and Black Nanotech only
Metalwork: **BT02..., BT03... and BT06...:** Silver, Black Graphite and White
Add surcharge for Praline, Olive Green, Atlantic Blue, Sapphire Blue, Mustard Yellow, Terracotta and Conker Brown (2 Week Lead Time)
BT05...: Chrome



BT02/SQR08



Square Top

Square Bar Table

- Standard lead time.
- 25mm top panel.
- 80mm diameter column.
- 500mm square x 5mm deep weighted base.

BT02/SQR06 - Square Top - 600w x 600d x 1100h



BT03/CIR8



Circular Top

Circular Bar Table

- Standard lead time.
- 25mm top panel.
- 80mm diameter column.
- 600mm diameter x 5mm deep weighted base.

BT03/CIR06 - Circular Top - 600w (dia) x 1100h



BT05/CIR06

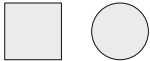

Square and Circular Top

Square / Circular Trumpet Based Bar Table

- Standard lead time.
- 25mm top panel.
- 60mm diameter column.
- Weighted 490mm circular base.
- Protective feet.
- Available in Chrome only.

BT05/SQR06 - Square Top - 600w x 600d x 1095h

BT05/CIR06 - Circular Top - 600w (dia) x 1095h



BT06/SQR06



Square and Circular Top

Square / Circular Pyramid Based Bar Table

- Standard lead time.
- 25mm top panel.
- 60mm diameter column.
- 475mm square x 8mm deep pyramid base.
- Levelling feet.

BT06/SQR06 - Square Top - 600w x 600d x 1095h

BT06/CIR06 - Circular Top - 600w (dia) x 1095h

Modular Tables

Bar Tables

MFC: Available in Ash, Autumn Cherry, Beech, Chester Oak, English Walnut, Grey, Grey Nebraska Oak, Laurentii Wenge, Natural Nebraska Oak and White
Nanotech: Available in Black (2 Week Lead Time)
Veneer: Available in Oak and Walnut (3 Week Lead Time)
Edging: Add surcharge for Wenge, Black and Plywood Effect per top - Edging on 25mm White MFC and Black Nanotech only
Metalwork: **BT07... and BT08...** Silver, Black Graphite and White
Add surcharge for Praline, Olive Green, Atlantic Blue, Sapphire Blue, Mustard Yellow, Terracotta and Conker Brown (2 Week Lead Time)



BT07/CIR06

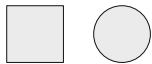

Square and Circular Top

Square / Circular Bar Table

- Standard lead time. • 25mm top panel. • 60mm diameter column.
- Weighted 470mm diameter x 5mm deep base. • Protective feet.

BT07/SQR06 - Square Top - 600w x 600d x 1095h

BT07/CIR06 - Circular Top - 600w (dia) x 1095h



BT08/CIR06



Square and Circular Top

Square / Circular Bar Table

- Standard lead time. • 25mm top panel. • 50mm diameter column.
- Weighted 480mm diameter trumpet base. • Levelling feet.

BT08/SQR06 - Square Top - 600w x 600d x 1095h

BT08/CIR06 - Circular Top - 600w (dia) x 1095h



Modular Tables

Coffee Tables

MFC: Available in Ash, Autumn Cherry, Beech, Chester Oak, English Walnut, Grey, Grey Nebraska Oak, Laurentii Wenge, Natural Nebraska Oak and White
Nanotech: Available in Black (2 Week Lead Time)
Veneer: Available in Oak and Walnut (3 Week Lead Time)
Edging: Add surcharge for Wenge, Black and Plywood Effect per top - Edging on 25mm White MFC and Black Nanotech only
Metalwork: **CT02... and CT03...:** Silver, Black Graphite and White
Add surcharge for Praline, Olive Green, Atlantic Blue, Sapphire Blue, Mustard Yellow, Terracotta and Conker Brown (2 Week Lead Time)
CT11... and CT12...: Chrome



CT02/SQR10



Square Top

Square Coffee Table

- Standard lead time.
- 25mm top panel.
- 80mm diameter column.
- 500mm square x 5mm deep base.

CT02/SQR10 - Square Top - 1000w x 1000d x 425h

CT02/SQR08 - Square Top - 800w x 800d x 425h



CT03/CIR10



Circular Top

Circular Coffee Table

- Standard lead time.
- 25mm top panel.
- 80mm diameter column.
- 600mm diameter x 5mm deep base.

CT03/CIR10 - Circular Top - 1000w (dia) x 425h

CT03/CIR08 - Circular Top - 800w (dia) x 425h



CT11/CIR08

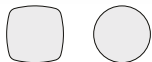

Squircle and Circular Top

Squircle / Circular Coffee Table for Cascara and Myla

- Standard lead time.
- 25mm top panel.
- 50mm diameter column.
- 655mm four-star base.
- Available in Chrome only.
- Complements Cascara and Myla seating range (See the Elite Seating Guide).

CT11/SQC08 - Squircle Top - 800w x 800d x 425h

CT11/SQC06 - Squircle Top - 600w x 600d x 425h

CT11/CIR08 - Circular Top - 800w (dia) x 425h



CT12/CIR08



Squircle and Circular Top

Squircle / Circular Coffee Table

- Standard lead time.
- 25mm top panel.
- 50mm diameter column.
- 680mm four-star base.
- Levelling feet.
- Available in Chrome only.

CT12/SQC08 - Squircle Top - 800w x 800d x 425h

CT12/SQC06 - Squircle Top - 600w x 600d x 425h

CT12/CIR08 - Circular Top - 800w (dia) x 425h

Modular Tables

Coffee Tables

MFC: Available in Ash, Autumn Cherry, Beech, Chester Oak, English Walnut, Grey, Grey Nebraska Oak, Laurentii Wenge, Natural Nebraska Oak and White
Nanotech: Available in Black (2 Week Lead Time)
Veneer: Available in Oak and Walnut (3 Week Lead Time)
Edging: Add surcharge for Wenge, Black and Plywood Effect per top - Edging on 25mm White MFC and Black Nanotech only
Metalwork: **ESC...:** Silver, Black Graphite and White
 Add surcharge for Praline, Olive Green, Atlantic Blue, Sapphire Blue, Mustard Yellow, Terracotta and Conker Brown (2 Week Lead Time)
CTB...: Polished Base - Add surcharge for a Black Base



ESC SCT

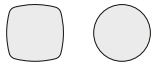

Squircle and Circular Top

Squircle / Circular Coffee Table for Escape

- Standard lead time. • 25mm top panel.
- 12mm chromed wire sled base. • Chrome as standard.
- Complements Escape seating range (See the Elite Seating Guide).

ESC SCT - Squircle Top - 600w x 600d x 415h

ESC CCT - Circular Top - 700w (dia) x 415h



CTB/SQC08/4/P4S

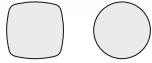

Squircle and Circular Top

Canterbury Squircle / Circular Coffee Table

- Standard lead time. • 25mm top panel. • Polished or black aluminium four-star base.
- Complements Tempo, Elipsa, Cascara, Myla and Luma seating ranges (See the Elite Seating Guide).

CTB/SQC08/5... - Squircle Top - 800w x 800d x 500h

CTB/SQC06/5... - Squircle Top - 600w x 600d x 500h

CTB/CIR08/5... - Circular Top - 800w (dia) x 500h

CTB/SQC08/4... - Squircle Top - 800w x 800d x 400h

CTB/SQC06/4... - Squircle Top - 600w x 600d x 400h

CTB/CIR08/4... - Circular Top - 800w (dia) x 400h

Finishes: Polished Base (.../P4S)
 Add surcharge for a Black Base (.../B4S)



Modular Tables

Coffee Tables

MFC: Available in Ash, Autumn Cherry, Beech, Chester Oak, English Walnut, Grey, Grey Nebraska Oak, Laurentii Wenge, Natural Nebraska Oak and White
Nanotech: Available in Black (2 Week Lead Time)
Veneer: Available in Oak and Walnut (3 Week Lead Time)
Edging: Add surcharge for Wenge, Black and Plywood Effect per top - Edging on 25mm White MFC and Black Nanotech only
Metalwork: **EVOP..., DAL... and ELL...:** Detailed below



EVOPRCT



EVOPRCT/CFL/SF



Square and Rectangular Top

Rectangular / Square Coffee Table for Evo Plus

- 25mm top panel. • Chrome effect paint as standard.
- Complements Evo Plus seating range (See the Elite Seating Guide).

EVOPSCTL... - Square Top - 700w x 700d x 405h
EVOPSCT... - Square Top - 550w x 550d x 405h

EVOPRCTL... - Rectangular Top - 1200w x 550d x 405h
EVOPRCT... - Rectangular Top - 800w x 550d x 405h

Finishes:

For Standard Leg

Chrome Effect (no suffix)

Add surcharge for Silver (.../SF), Black Graphite (.../BGF), White (.../WF), Black Chrome (.../BCF).

Black (.../BF), Praline (.../PLF), Olive Green (.../OVF), Atlantic Blue (.../ABF),

Sapphire Blue (.../SBF), Mustard Yellow (.../MYF), Terracotta (.../TCF) and Conker Brown (.../CBF)

For Cubeform Leg

Add surcharge for Silver (.../CFL/SF), Black Graphite (.../CFL/BGF), White (.../CFL/WF),

Chrome Effect (.../CFL/CF), Black (.../CFL/BF), Praline (.../CFL/PLF), Olive Green (.../CFL/OVF),

Atlantic Blue (.../CFL/ABF), Sapphire Blue (.../CFL/SBF), Mustard Yellow (.../CFL/MYF),

Terracotta (.../CFL/TCF) and Conker Brown (.../CFL/CBF)



DALRCT



Square and Rectangular Top

Rectangular / Square Coffee Table for Dalton

- 25mm top panel. • Brushed Silver or Black Chromed legs.
- Complements Dalton seating range (See the Elite Seating Guide).

DALSCTL... - Square Top - 700w x 700d x 405h
DALSCT... - Square Top - 550w x 550d x 405h

DALRCTL... - Rectangular Top - 1200w x 550d x 405h
DALRCT... - Rectangular Top - 800w x 550d x 405h

Finishes:

Brushed Silver (.../SF) and Black Chrome (.../BCF)



ELLRCT



Square and Rectangular Top

Rectangular / Square Coffee Table for Ella

- Standard lead time. • 25mm top panel. • 5mm steel sled legs.
- Chrome effect paint as standard. • Epoxy powder coated finish.
- Complements Ella seating range (See the Elite Seating Guide).

ELLSCTL... - Square Top - 800w x 800d x 405h
ELLSCT... - Square Top - 550w x 550d x 405h

ELLRCTL... - Rectangular Top - 1200w x 550d x 405h
ELLRCT... - Rectangular Top - 800w x 550d x 405h

Finishes:

Chrome Effect (no suffix), Silver (.../SF), Black Graphite (.../BGF) and White (.../WF)

Add surcharge for Black (.../BF), Praline (.../PLF), Olive Green (.../OVF), Atlantic Blue (.../ABF),

Sapphire Blue (.../SBF), Mustard Yellow (.../MYF), Terracotta (.../TCF) and Conker Brown (.../CBF)

Modular Tables

Coffee Tables

MFC: Available in Ash, Autumn Cherry, Beech, Chester Oak, English Walnut, Grey, Grey Nebraska Oak, Laurentii Wenge, Natural Nebraska Oak and White
Nanotech: Available in Black (2 Week Lead Time)
Veneer: Available in Oak and Walnut (3 Week Lead Time)
Edging: Add surcharge for Wenge, Black and Plywood Effect per top - Edging on 25mm White MFC and Black Nanotech only
Metalwork: Silver, Black Graphite and White - Add surcharge for Raw
Add surcharge for Praline, Olive Green, Atlantic Blue, Sapphire Blue, Mustard Yellow, Terracotta and Conker Brown (2 Week Lead Time)



CF/RCT1



Rectangular Top

Cubeform Rectangular Coffee Table

- Standard lead times. • 25mm top panel.

CF/RCT1 - 900w x 475d x 400h



CF/SCT1



Square Top

Cubeform Square Coffee Table

- Standard lead times. • 25mm top panel.

CF/SCT1 - 475w x 475d x 400h

CF/SCT2 - 900w x 900d x 400h



CF/RCT1/BP



Rectangular Top

Cubeform Rectangular Coffee Table with Base Panel

- Standard lead times. • 25mm top panel and 18mm base panel.

CF/RCT1/BP - 900w x 475d x 400h



CF/SCT1/BP



Square Top

Cubeform Square Coffee Table with Base Panel

- Standard lead times. • 25mm top panel and 18mm base panel.

CF/SCT1/BP - 475w x 475d x 400h

CF/SCT2/BP - 900w x 900d x 400h



Modular Tables

Coffee Tables

MFC: Available in Ash, Autumn Cherry, Beech, Chester Oak, English Walnut, Grey, Grey Nebraska Oak, Laurentii Wenge, Natural Nebraska Oak and White
Nanotech: Available in Black (2 Week Lead Time)
Veneer: Available in Oak and Walnut (3 Week Lead Time)
Edging: Add surcharge for Wenge, Black and Plywood Effect per top - Edging on 25mm White MFC and Black Nanotech only
Metalwork: **SCT800, CCT750L and TCT900:** Silver, Black Graphite and White - Add surcharge for Chrome Effect
Add surcharge for Praline, Olive Green, Atlantic Blue, Sapphire Blue, Mustard Yellow, Terracotta and Conker Brown (2 Week Lead Time)



RCT900



Rectangular Top

Rectangular Panel Ended Coffee Table

- Standard lead time.
- 25mm top panel.
- 25mm panel end base.
- Middle support panel.

RCT900 - Rectangular Top - 900w x 530d x 385h



CCT750



Circular Top

Circular Coffee Table

- Standard lead time.
- 25mm top panel.
- 25mm panelled cross base.

CCT750 - Circular Top - 750w (dia) x 400h



SCT800



CCT750L



TCT900

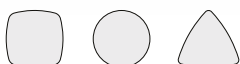

Squircle, Circular and Triangular Top

Squircle / Circular / Triangular Coffee Table

- Standard lead time.
- 25mm top panel.
- Squircle and circular table has 4 tapered legs.
- Triangular table has 3 tapered legs.

SCT800 - Squircle Top - 800w x 800d x 400h

CCT750L - Circular Top - 750w (dia) x 400h

TCT900 - Triangular Top - 900w (dia) x 400h

Modular Tables

Coffee Tables

MFC: Available in Ash, Autumn Cherry, Beech, Chester Oak, English Walnut, Grey, Grey Nebraska Oak, Laurentii Wenge, Natural Nebraska Oak and White
Nanotech: Available in Black (2 Week Lead Time)
Veneer: Available in Beech, Stained Walnut, Stained Espresso, Stained Wenge, Stained Black, Stained Grey and White to match legs (3 Week Lead Time)
Edging: Add surcharge for Wenge, Black and Plywood Effect per top - Edging on 25mm White MFC and Black Nanotech only



HEN/SQC08/5/ASL

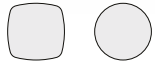

Squirrelle and Circular Top

Henley Squirrelle / Circular Coffee Table

- Standard lead time.
- 25mm top panel.
- Wooden 4 star pyramid base.
- Available at 500h and 400h.
- On veneered items, the below finishes apply to the whole unit.
- Complements Elipsa, Cascara, Myla and Luma seating ranges (See the Elite Seating Guide).

HEN/SQC08/5... - Squirrelle Top - 800w x 800d x 500h
HEN/SQC06/5... - Squirrelle Top - 600w x 600d x 500h

HEN/CIR08/5... - Circular Top - 800w (dia) x 500h
HEN/CIR06/5... - Circular Top - 600w (dia) x 500h

HEN/SQC08/4... - Squirrelle Top - 800w x 800d x 400h
HEN/SQC06/4... - Squirrelle Top - 600w x 600d x 400h

HEN/CIR08/4... - Circular Top - 800w (dia) x 400h
HEN/CIR06/4... - Circular Top - 600w (dia) x 400h

Finishes: Ash (.../ASL) Legs
Add surcharge for Stained Walnut (.../WAL), Stained Espresso (.../ESL), Stained Wenge (.../WEL), Stained Grey (.../GYL), Stained Black (.../BKL) and White (.../WHL) Legs



Modular Tables

Coffee Tables

MFC: Available in Ash, Autumn Cherry, Beech, Chester Oak, English Walnut, Grey, Grey Nebraska Oak, Laurentii Wenge, Natural Nebraska Oak and White
Nanotech: Available in Black (2 Week Lead Time)
Veneer: Available in Beech, Stained Walnut, Stained Espresso, Stained Wenge, Stained Black, Stained Grey and White to match legs (3 Week Lead Time)
Edging: Add surcharge for Wenge, Black and Plywood Effect per top - Edging on 25mm White MFC and Black Nanotech only
Metalwork: **GCT...:** Detailed below



OXFRCT/ESL



Rounded Rectangular Top

Oxford Rounded Rectangular Coffee Table

- 3 week lead time.
- 25mm top panel.
- On veneered items, the below finishes apply to the whole unit.
- Complements Kouch seating range (See the Elite Seating Guide).

OXFRCT... - Rounded Rectangular Top - 1100w x 700d x 330h

Finishes: Beech (.../BEL) Legs
Add surcharge for Stained Walnut (.../WAL), Stained Espresso (.../ESL), Stained Wenge (.../WEL), Stained Grey (.../GYL), Stained Black (.../BKL) and White (.../WHL) Legs



CBGCCT/ESL



Circular Top

Cambridge Circular Coffee Table

- 3 week lead time.
- 25mm top panel.
- On veneered items, the below finishes apply to the whole unit.
- Complements Kouch seating range (See the Elite Seating Guide).

CBGCCT... - Circular Top - 600w (dia) x 400h

Finishes: Beech (.../BEL) Legs
Add surcharge for Stained Walnut (.../WAL), Stained Espresso (.../ESL), Stained Wenge (.../WEL), Stained Grey (.../GYL), Stained Black (.../BKL) and White (.../WHL) Legs



GCT9



Rectangular Top

Clear Glass Rectangular Coffee Table

- Standard lead time.
- 10mm polished toughened glass.
- Brushed steel and silver rod design.

GCT9 - Rectangular Top - 1200w x 600d x 420h



GCT10



Circular Top

Clear Glass Circular Coffee Table

- Standard lead time.
- 8mm polished toughened glass.
- Silver tubular base.

GCT10 - Circular Top - 500w (dia) x 590h

Modular Tables

Switch Mobile Whiteboard TV Unit

4 Week Lead Time

MFC:	Available in Ash, Autumn Cherry, Beech, Chester Oak, English Walnut, Grey, Grey Nebraska Oak, Laurentii Wenge, Natural Nebraska Oak and White
Coloured:	Available in Praline, Olive Green, Atlantic Blue, Sapphire Blue, Mustard Yellow, Terracotta and Conker Brown
Nanotech:	Available in Black (2 Week Lead Time)
Metalwork:	Silver, Black Graphite and White
Fabric:	Fully upholstered - See below for pricing groups



SWI/MTVU/TV



SWI/MTVU/TV

Switch Mobile TV and Whiteboard Unit

- Compatible with TVs with a maximum weight of 16kg.
- 4 week lead time.
- 55" 4K TV (Branded), mounted by special hinged bracket.
- Flush mount surface power and media module (1x power socket, 1x USB twin charger (A+C), 1x HDMI and 1x USB (A)).
- Magnetic dry wipe whiteboard is 1310w x 1010h.
- Designer castors.
- Power connection via side panel.
- Supplied with 3m 90 degree IEC power cable as standard.

SWI/MWTVU/TV - 1400w x 535d x 1890h

Fabric Groups: Group 1 - Add surcharge for Group 2-7



IEC90/5

IEC 90 Degree Power Cable

- Above supplied with 3000w as standard - see alternative below.
- Standard lead time.
- Black cable and plug.
- 13amp fused.

IEC90/7 - 7000mm
IEC90/5 - 5000mm
IEC90/2 - 2000mm

Modular Tables

TV and Computer Tables

MFC: Available in Ash, Autumn Cherry, Beech, Chester Oak, English Walnut, Grey, Grey Nebraska Oak, Laurentii Wenge, Natural Nebraska Oak and White
Coloured MFC: Available in Praline, Olive Green, Atlantic Blue, Sapphire Blue, Mustard Yellow, Terracotta and Conker Brown (2 Week Lead Time)
Veneer: Available in Oak and Walnut (3 Week Lead Time)
Edging: Add surcharge for Wenge, Black and Plywood Effect per top - Edging on 25mm White MFC only
Metalwork: **MTVU:** Silver, Black Graphite and White - Add surcharge for Chrome Effect
LUN..: Silver, Black Graphite and White - Add surcharge for Chrome Effect and Raw
 Add surcharge for Praline, Olive Green, Atlantic Blue, Sapphire Blue, Mustard Yellow, Terracotta and Conker Brown (2 Week Lead Time)



MTVU

Mobile TV Unit

- Standard lead time. • 25mm top panel.
- Horizontal wire management tray (accommodates optional power modules).
- Vertical wire management access via removal of leg upright cover plates.
- Compatible with a TV up to 56". • Maximum TV weight of 50KG.
- Locking castors. • Universal bracket fixing.

MTVU - 900w x 800d x 1785h



LUNT and LUNO



Trapezoidal and Oval Top

Luna Laptop Table

- Standard lead time. • 18mm top panel. • 50mm tubular column.
- 10mm laser cut steel base. • Protective glides.

LUNT - Trapezoidal Top - 520w x 425d x 630h

LUNO - Oval Top - 600w x 500d x 630h

Modular Tables

Mobile Whiteboard Unit

Metalwork:

Silver, Black Graphite and White

Add surcharge for Praline, Olive Green, Atlantic Blue, Sapphire Blue, Mustard Yellow, Terracotta and Conker Brown (2 Week Lead Time)



MWBP

Mobile Portrait Whiteboard Unit

- Standard lead time.
- Mobile drywipe whiteboard.
- Portrait (900w x 1200h) orientation.
- 360 degree rotation.
- Magnetic.
- Storage tray.
- 2x locking castors.

MWBP - 1000w x 620d x 1850h



MWBL

Mobile Landscape Whiteboard Unit

- Standard lead time.
- Mobile drywipe whiteboard.
- Landscape (1200w x 900h) orientation.
- 360 degree rotation.
- Magnetic.
- Storage tray.
- 2x locking castors.

MWBL - 1300w x 620d x 1700h

Modular Tables

Compatibility Breakdown

Modular Tables Compatibility Breakdown

● Black - Compatible

	Kaspa, page 294	Prime, page 294	Boardroom, page 295	Conus, page 296	Peak, page 297	Escalate, page 297	Wireless Charging Unit, page 298	Port Hole, page 299	Pix, page 299	Pluto, page 300	Inca, page 300	Flex, page 301	Boost, page 301	Capsule, page 302	Plaza, page 303	Wieland Socket Boxes, page 303
Modular Meeting - Fliptop Rectangular and Semi-circular	●	●	●	●	●	●	●	●	●	●	●	●	●	●	●	●
Modular Meeting - Fliptop Circular												●		●		
Modular Meeting - Folding							●			●	●	●		●		
Modular Meeting - Training	●	●	●	●	●	●	●	●	●	●	●	●	●	●	●	●
Modular Meeting - Vista	●	●					●	●	●	●	●					
Modular Meeting - Piazza and Piazza	●	●	●	●	●	●	●	●	●	●	●	●		●		
Modular Meeting - Meeting MT01						●	●	●	●	●	●	●		●		
Modular Meeting - Meeting MT13	●	●	●	●	●	●	●	●	●	●	●	●	●	●	●	●
Modular Meeting - Meeting All Others												●		●		
Modular Meeting - Bar												●		●		
Modular Meeting - Coffee ESC, ELL, EVOP, CCT750L, SCT800 and TCT900	●	●	●	●	●	●	●	●	●	●	●	●	●	●	●	●
Modular Meeting - Coffee Cubeform	●	●	●	●	●	●	●	●	●	●	●					
Modular Meeting - Coffee All Others												●		●		
Modular Meeting - TV	●	●	●	●	●	●	●	●	●	●	●	●	●	●	●	●
Modular Meeting - Laptop												●		●		
Modular Meeting - Whiteboard																●



Pedestals and Personal Storage

Mobile and Desk High Pedestals, Desktop and Personal Storage and Handles



The Elite pedestal portfolio is comprehensive and provides solutions for large volumes, mobile and personal storage. Traditional two-door, tambour fronted storage and pedestals are available in either MFC or Steel structures. Within the units, the internal system can be personalised to meet current and future filing or storage requirements.



Pedestals

Low Underdesk Pedestals

MFC: Available in Ash, Autumn Cherry, Beech, Chester Oak, English Walnut, Grey, Grey Nebraska Oak, Laurentii Wenge, Natural Nebraska Oak and White
Veneer: Available in Oak and Walnut (3 Week Lead Time)
Fabric: Fully upholstered seat pads - See individual items for pricing groups



MPF and MPF/SP



MP3 and MP3/SP

2 and 3 Drawer Low Mobile Pedestal

- Standard lead times.
- 18mm top panel.
- Lockable, includes 2x keys.
- Optional seat pad is 62mm from top of the unit and is supplied with self adhesive pads.
- Seat pad priced in Group 1.
- Alternative handles available (page 222).

1x Single and 1x Filing Drawer

MPF - 418w x 600d x 480h - Standard Drawers
MPF/SP - 418w x 600d x 542h - Standard Drawers and Seat Pad

3x Single Drawers

MP3 - 418w x 600d x 480h - Standard Drawers
MP3/SP - 418w x 600d x 542h - Standard Drawers and Seat Pad

Fabric Groups: Group 1 - Add surcharge for Group 2-7



MPFM and MPFM/SP



MP3M and MP3M/SP

2 and 3 Drawer Low Mobile Pedestal on Castors

- Standard lead times.
- 18mm top panel.
- Lockable, includes 2x keys.
- Optional seat pad is 62mm from top of the unit and is supplied with self adhesive pads.
- Seat pad priced in Group 1.
- Alternative handles available (page 222).

1x Single and 1x Filing Drawer

MPFM - 418w x 600d x 547h - Standard Drawers
MPFM/SP - 418w x 600d x 609h - Standard Drawers and Seat Pad

3x Single Drawers

MP3M - 418w x 600d x 547h - Standard Drawers
MP3M/SP - 418w x 600d x 609h - Standard Drawers and Seat Pad

Fabric Groups: Group 1 - Add surcharge for Group 2-7



MTFP

Mobile Tambour Filing Pedestal on Castors

- Standard lead times.
- 18mm top panel.
- Lockable, includes 2x keys.
- 1x tambour compartment and filing drawer.
- Filing drawer will accommodate A4 and foolscap filing.
- Alternative handles available (page 222).

Tambour Front and 1x Filing Drawer

MTFP - 420w x 600d x 595h - Standard Drawer

Pedestals

Underdesk Pedestals

MFC: Available in Ash, Autumn Cherry, Beech, Chester Oak, English Walnut, Grey, Grey Nebraska Oak, Laurentii Wenge, Natural Nebraska Oak and White
Veneer: Available in Oak and Walnut (3 Week Lead Time)



DMPO/N

Open Fronted Narrow Mobile Pedestal

- Standard lead times.
- 18mm top panel.
- Open fronted for PC tower storage.
- Ventilated back panel.

Open Fronted

DMPO/N - 298w x 600d x 640h



DMPF/N

3 Drawer Narrow Mobile Pedestal

- Standard lead times.
- 18mm top panel.
- Lockable, includes 2x keys.
- Alternative handles available (page 222).

2x Single and 1x Filing Drawer

DMPF/N - 298w x 600d x 640h - Standard Drawers

SDMPF/N - 298w x 600d x 640h - System Drawers



DMP4/N

4 Drawer Narrow Mobile Pedestal

- Standard lead times.
- 18mm top panel.
- Lockable, includes 2x keys.
- Alternative handles available (page 222).

4x Single Drawers

DMP4/N - 298w x 600d x 640h - Standard Drawers

SDMP4/N - 298w x 600d x 640h - System Drawers



DMPF

3 Drawer Mobile Pedestal

- Standard lead times.
- 18mm top panel.
- Lockable, includes 2x keys.
- Alternative handles available (page 222).

2x Single and 1x Filing Drawer

DMPF - 418w x 600d x 640h - Standard Drawers

SDMPF - 418w x 600d x 640h - System Drawers



DMP4

4 Drawer Mobile Pedestal

- Standard lead times.
- 18mm top panel.
- Lockable, includes 2x keys.
- Alternative handles available (page 222).

4x Single Drawers

DMP4 - 418w x 600d x 640h - Standard Drawers

SDMP4 - 418w x 600d x 640h - System Drawers

Pedestals

Steel Pedestals

6 Week Lead Time

Metalwork: Silver, Black Graphite and White



DMSF/N/F

3 Drawer Narrow Steel Flat Fronted Mobile Pedestal

- Standard lead times.
- Lockable, includes 2x keys.
- Supplied with pen tray.

2x Single and 1x Filing Drawer

DMSF/N/F... - 300w x 520d x 600h

Finishes: Silver (no suffix), Black Graphite (.../BG) and White (.../W)



DMSF/F

3 Drawer Steel Flat Fronted Mobile Pedestal

- Standard lead times.
- Lockable, includes 2x keys.
- Supplied with pen tray.

2x Single and 1x Filing Drawer

DMSF/F... - 390w x 520d x 600h

Finishes: Silver (no suffix), Black Graphite (.../BG) and White (.../W)



Pedestals

Desk High Pedestals

MFC: Available in Ash, Autumn Cherry, Beech, Chester Oak, English Walnut, Grey, Grey Nebraska Oak, Laurentii Wenge, Natural Nebraska Oak and White
Veneer: Available in Oak and Walnut (3 Week Lead Time)
Edging: Add surcharge for Wenge, Black and Plywood Effect per top - Edging on 25mm White MFC only



DHP2/6

2 Drawer Desk High Pedestal

- Standard lead times.
- 25mm top panel.
- Lockable, includes 2x keys.
- Anti-tilt device.
- Alternative handles available (page 222).

2x Filing Drawers

DHP2/6 - 466w x 600d x 740h - Standard Drawers



DHPF

3 Drawer Desk High Pedestal

- Standard lead times.
- 25mm top panel.
- Lockable, includes 2x keys.
- Anti-tilt device.
- Alternative handles available (page 222).

2x Single and 1x Filing Drawer

DHPF - 418w x 600d x 740h - Standard Drawers

SDHPF - 418w x 600d x 740h - System Drawers



DHP4

4 Drawer Desk High Pedestal

- Standard lead times.
- 25mm top panel.
- Lockable, includes 2x keys.
- Anti-tilt device.
- Alternative handles available (page 222).

4x Single Drawers

DHP4 - 418w x 600d x 740h - Standard Drawers

SDHP4 - 418w x 600d x 740h - System Drawers



DHP2/8

2 Drawer Deep Desk High Pedestal

- Standard lead times.
- 25mm top panel.
- Lockable, includes 2x keys.
- Anti-tilt device.
- Alternative handles available (page 222).

2x Filing Drawers

DHP2/8 - 466w x 800d x 740h - Standard Drawers



DHPF/8

3 Drawer Deep Desk High Pedestal

- Standard lead times.
- 25mm top panel.
- Lockable, includes 2x keys.
- Anti-tilt device.
- Alternative handles available (page 222).

2x Single and 1x Filing Drawer

DHPF/8 - 418w x 800d x 740h - Standard Drawers

SDHPF/8 - 418w x 800d x 740h - System Drawers



DHP4/8

4 Drawer Deep Desk High Pedestal

- Standard lead times.
- 25mm top panel.
- Lockable, includes 2x keys.
- Anti-tilt device.
- Alternative handles available (page 222).

4x Single Drawers

DHP4/8 - 418w x 800d x 740h - Standard Drawers

SDHP4/8 - 418w x 800d x 740h - System Drawers

Pedestals

Desk High Pedestals

MFC: Available in Ash, Autumn Cherry, Beech, Chester Oak, English Walnut, Grey, Grey Nebraska Oak, Laurentii Wenge, Natural Nebraska Oak and White
Veneer: Available in Oak and Walnut (3 Week Lead Time)
Edging: Add surcharge for Wenge, Black and Plywood Effect per top - Edging on 25mm White MFC only



DHP2/6L

2 Drawer Desk High Pedestal with Straight Overhanging Top

- Standard lead times.
- Left-hand and right-hand versions available.
- 25mm top panel.
- Lockable, includes 2x keys.
- Anti-tilt device.
- Alternative handles available (page 222).

2x Filing Drawers

DHP2/6... (L or R) - 1000w x 600d x 740h - Standard Drawers



DHPF/L

3 Drawer Desk High Pedestal with Straight Overhanging Top

- Standard lead times.
- Left-hand and right-hand versions available.
- 25mm top panel.
- Lockable, includes 2x keys.
- Anti-tilt device.
- Alternative handles available (page 222).

2x Single and 1x Filing Drawer

DHPF/... (L or R) - 1000w x 600d x 740h - Standard Drawers

SDHPF/... (L or R) - 1000w x 600d x 740h - System Drawers



DHP4/L

4 Drawer Desk High Pedestal with Straight Overhanging Top

- Standard lead times.
- Left-hand and right-hand versions available.
- 25mm top panel.
- Lockable, includes 2x keys.
- Anti-tilt device.
- Alternative handles available (page 222).

4x Single Drawers

DHP4/... (L or R) - 1000w x 600d x 740h - Standard Drawers

SDHP4/... (L or R) - 1000w x 600d x 740h - System Drawers



DHP2/8L

2 Drawer Desk High Pedestal with Curved Overhanging Top

- Standard lead times.
- Left-hand and right-hand versions available.
- 25mm top panel.
- Lockable, includes 2x keys.
- Anti-tilt device.
- Alternative handles available (page 222).

2x Filing Drawers

DHP2/8... (L or R) - 1000w x 800-600d x 740h - Standard Drawers



DHPF/8L

3 Drawer Desk High Pedestal with Curved Overhanging Top

- Standard lead times.
- Left-hand and right-hand versions available.
- 25mm top panel.
- Lockable, includes 2x keys.
- Anti-tilt device.
- Alternative handles available (page 222).

2x Single and 1x Filing Drawer

DHPF/8... (L or R) - 1000w x 800-600d x 740h - Standard Drawers

SDHPF/8... (L or R) - 1000w x 800-600d x 740h - System Drawers



DHP4/8L

4 Drawer Desk High Pedestal with Curved Overhanging Top

- Standard lead times.
- Left-hand and right-hand versions available.
- 25mm top panel.
- Lockable, includes 2x keys.
- Anti-tilt device.
- Alternative handles available (page 222).

4x Single Drawers

DHP4/8... (L or R) - 1000w x 800-600d x 740h - Standard Drawers

SDHP4/8... (L or R) - 1000w x 800-600d x 740h - System Drawers

Pedestals

Desktop Storage

MFC: Available in Ash, Autumn Cherry, Beech, Chester Oak, English Walnut, Grey, Grey Nebraska Oak, Laurentii Wenge, Natural Nebraska Oak and White
Veneer: Available in Oak and Walnut (3 Week Lead Time)
Edging: Add surcharge for Wenge, Black and Plywood Effect per top - Edging on 25mm White MFC only



DHPSU/8

Open Fronted Pedestal-top Storage Unit

- Standard lead times.
- 25mm top panel.
- Suitable for A4 lever arch filing.

Open Fronted

DHPSU/8 - 418w x 800d x 375h



DHPSU/8STRH

Tambour Fronted Pedestal-top Storage Unit

- Standard lead times.
- Left-hand and right-hand versions available.
- 25mm top panel.
- Suitable for A4 lever arch filing.
- 1x lockable side opening tambour door, includes 2x keys.
- Silver door only.
- Alternative handles available (page 222).

Tambour Fronted

DHPSU/8ST... (LH or RH) - 418w x 800d x 375h



DTO16

Desktop Organiser

- Standard lead times.
- 25mm top panel.
- Complete with shelving.

Open Fronted

DTO18 - 1800w x 300d x 355h

DTO16 - 1600w x 300d x 355h

DTO14 - 1400w x 300d x 355h

DTO12 - 1200w x 300d x 355h

Pedestals

Low Underdesk Storage and Accessories

MFC: Available in Ash, Autumn Cherry, Beech, Chester Oak, English Walnut, Grey, Grey Nebraska Oak, Laurentii Wenge, Natural Nebraska Oak and White
Veneer: Available in Oak and Walnut (3 Week Lead Time)
Edging: Add surcharge for Wenge, Black and Plywood Effect per top - Edging on 25mm White MFC only



MPP2DLH



MPP2DLH/SP

2 Drawer Single Sided Mobile Personal Storage Unit

- Standard lead times. • 18mm top panel. • Suitable for 1x row of A4 ringbinders.
- Complete with 1x adjustable shelf. • Lockable, includes 2x keys.
- Seat pad priced in Group 1. • Alternative handles available (page 222).

1x Single and 1x Filing Drawer

MPP2D... (LH or RH) - 1000w x 600d x 570h - Standard Drawers
MPP2D... (LH/SP or RH/SP) - 1000w x 600d x 632h - Standard Drawers and Seat Pad

Fabric Groups: Group 1 - Add surcharge for Group 2-7



MPP3DLH



MPP3DLH/SP

3 Drawer Single Sided Mobile Personal Storage Unit

- Standard lead times. • 18mm top panel. • Suitable for 1x row of A4 ringbinders.
- Complete with 1x adjustable shelf. • Lockable, includes 2x keys.
- Seat pad priced in Group 1. • Alternative handles available (page 222).

3x Single Drawers

MPP3D... (LH or RH) - 1000w x 600d x 570h - Standard Drawers
MPP3D... (LH/SP or RH/SP) - 1000w x 600d x 632h - Standard Drawers and Seat Pad

Fabric Groups: Group 1 - Add surcharge for Group 2-7



PT

Pen and Stationery Tray

- Standard lead times. • Black plastic overlay tray. • Comprises of 6x compartments.
- For use with 418mm wide pedestals.

For Standard Pedestals

PT - 335w x 175d x 30h

For System Pedestals

SPT - 360w x 175d x 30h



SDDK

Drawer Divider Kit

- Standard lead times. • Kit comprises of 2x cross dividers, 2x small lateral dividers, 2x medium lateral dividers and 2x large lateral dividers.

For System Pedestals

SDDK

Pedestals

Handles

Metalwork:

Silver, Black Graphite and White

Add surcharge for Praline, Olive Green, Atlantic Blue, Sapphire Blue, Mustard Yellow, Terracotta and Conker Brown (2 Week Lead Time)



STD

Standard Metal Handle

- Standard lead times.
- 160mm centres.
- Supplied as standard on all items requiring handles.

STD	- Silver RAL 9006	- 168w x 10d x 25h
STD/BG	- Black Graphite	- 168w x 10d x 25h
STD/W	- White	- 168w x 10d x 25h



HAN/FLU

Metal Flush Handle

- 160mm centres.

HAN/FLU	- Silver RAL 9006	- 200w x 13d x 19h
HAN/FLU/BG	- Black Graphite	- 200w x 13d x 19h
HAN/FLU/W	- White	- 200w x 13d x 19h



BRG

Metal Bridge Handle

- 128mm centres.
- Not retrofittable.

BRG	- Silver RAL 9006	- 140w x 10d x 25h
BRG/BG	- Black Graphite	- 140w x 10d x 25h
BRG/W	- White	- 140w x 10d x 25h



CAM

Metal Camber Handle

- 128mm centres.
- Not retrofittable.

CAM	- Silver RAL 9006	- 155w x 5d x 25h
CAM/BG	- Black Graphite	- 155w x 5d x 25h
CAM/W	- White	- 155w x 5d x 25h



BAR

Metal T-Bar Handle

- 128mm centres.
- Not retrofittable.

BAR	- Silver RAL 9006	- 168w x 10d x 34h
BAR/BG	- Black Graphite	- 168w x 10d x 34h
BAR/W	- White	- 168w x 10d x 34h



SLB

Metal Slab Handle

- 128mm centres.
- Not retrofittable.

SLB	- Silver RAL 9006	- 188w x 10d x 30h
SLB/BG	- Black Graphite	- 188w x 10d x 30h
SLB/W	- White	- 188w x 10d x 30h



BOW

Metal Bow Handle

- 128mm centres.
- Not retrofittable.

BOW	- Silver RAL 9006	- 160w x 8d x 26h
BOW/BG	- Black Graphite	- 160w x 8d x 26h
BOW/W	- White	- 160w x 8d x 26h

Pedestals

Under Desk and Desk High Storage

MFC: Available in Ash, Autumn Cherry, Beech, Chester Oak, English Walnut, Grey, Grey Nebraska Oak, Laurentii Wenge, Natural Nebraska Oak and White
Veneer: Available in Oak and Walnut (3 Week Lead Time)
Edging: Add surcharge for Wenge, Black and Plywood Effect per top - Edging on 25mm White MFC only



SLSU



SLSU/SP

Single Sided Mobile Storage Unit

- Standard lead times. • 25mm top panel. • Suitable for 1x row of A4 ringbinders.
- Complete with 1x adjustable shelf. • Optional seat pad is 62mm from top of the unit.
- Optional seat pad is supplied with self adhesive pads. • Seat pad priced in Group 1.

Open Fronted

SLSU - 1000w x 400d x 630h

SLSU/SP - 1000w x 400d x 692h - Seat Pad

Fabric Groups: Group 1 - Add surcharge for Group 2-7



DLSU



DLSU/SP

Double Sided Mobile Storage Unit

- Standard lead times. • 25mm top panel. • Suitable for 1x row of A4 ringbinders (1x each side).
- Complete with 2x adjustable shelves (1x each side). • Optional seat pad is 62mm from top of the unit.
- Optional seat pad is supplied with self adhesive pads. • Seat pad priced in Group 1.

Open Fronted

DLSU - 1000w x 600d x 630h

DLSU/SP - 1000w x 600d x 692h - Seat Pad

Fabric Groups: Group 1 - Add surcharge for Group 2-7



SHSU



DHSU

Single Sided Desk High Mobile Storage Unit

- Standard lead times. • 25mm top panel. • Suitable for 1x row of A4 ringbinders.
- Complete with 1x adjustable shelf.

Open Fronted

SHSU - 1000w x 400d x 740h

SHSU/8 - 800w x 400d x 740h

Double Sided Desk High Mobile Storage Unit

- Standard lead times. • 25mm top panel. • Suitable for 1x row of A4 ringbinders (1x each side).
- Complete with 2x adjustable shelves (1x each side).

Open Fronted

DHSU - 1000w x 600d x 740h

DHSU/8 - 800w x 600d x 740h

Storage

Various Storage, Planter Boxes, Cubeform Range, Modular Lockers and Recycling Units



Elite's extensive storage options are specifically designed to complement the various desking ranges within our portfolio. Storage units are very easily configured and designed to function with different styles of accessory options. System internals are available to personalise storage and meet filing demand and expectation. A range of lockers with mobile hand-held storage devices promote flexible working and are ideal for non-fixed workplace environments. Our storage portfolio also incorporates a unit capable of controlling recycling efforts, with 2 or 3 segments to separate different recycling materials. Cubeform is our latest introduction which hosts a family of storage and informal tables solutions. Easily configured with multiple internals, the storage system can flawlessly interject any space creating designated areas or act alone to fulfil any storage needs.



Storage

Flare Boardroom Storage Unit

MFC:	Available in Ash, Autumn Cherry, Beech, Chester Oak, English Walnut, Grey, Grey Nebraska Oak, Laurentii Wenge, Natural Nebraska Oak and White
Nanotech:	Available in Black (2 Week Lead Time)
Veneer:	Available in Oak and Walnut (3 Week Lead Time)
Coloured:	Specific items available in Praline, Olive Green, Atlantic Blue, Sapphire Blue, Mustard Yellow, Terracotta and Conker Brown (2 Week Lead Time)
Edging:	Add surcharge for Wenge, Black and Plywood Effect per top - Edging on 25mm White MFC and Black Nanotech only



FLA7/5/D4



FLA7/5/D3



FLA7/5/D2

Flare Boardroom Storage Unit

- Standard lead time. • 25mm top panel. • 2 / 3 / 4x soft close hinged door mechanisms. • Lockable, includes 2x keys.
- All units supplied with 1 piece top and bottom. • Contrasting doors available on MFC and Black Nanotech only.
- Alternative handles available (page 222). • Additional shelves available (page 226).

4 Doors with 2x Adjustable Shelves

- FLA9/6/D4...** - 2000w x 600d x 900h
FLA9/5/D4... - 2000w x 500d x 900h

- FLA7/6/D4...** - 2000w x 600d x 740h
FLA7/5/D4... - 2000w x 500d x 740h

3 Doors with 2x Adjustable Shelves

- FLA9/6/D3...** - 1500w x 600d x 900h
FLA9/5/D3... - 1500w x 500d x 900h

- FLA7/6/D3...** - 1500w x 600d x 740h
FLA7/5/D3... - 1500w x 500d x 740h

2 Doors with 1x Adjustable Shelf

- FLA9/6/D2...** - 1000w x 600d x 900h
FLA9/5/D2... - 1000w x 500d x 900h

- FLA7/6/D2...** - 1000w x 600d x 740h
FLA7/5/D2... - 1000w x 500d x 740h

Finishes: Silver (.../SF), Black Graphite (.../BGF) and White (.../WF) Legs
 Add surcharge for Raw Metalwork (.../RF), Black (.../BF), Praline (.../PLF), Olive Green (.../OVF), Atlantic Blue (.../ABF), Sapphire Blue (.../SBF), Mustard Yellow (.../MYF), Terracotta (.../TCF), Conker Brown (.../CBF), Chrome Effect (.../CF) Legs

Finishes: Standard MFC Contrasting Door Finish (.../CON)
 Add surcharge (on MFC) per door for Coloured MFC Contrasting Door Finish (.../CON)
 Add surcharge (on MFC) per door for Nanotech Contrasting Door Finish (.../CON)
 Further information required, contact Customer Services for a specification form

Handles: Standard Handles
 Add surcharge per door for Push release Open/Close Mechanism (.../PH)

Additional: Add surcharge per Fridge Cut-Out on 600d Double Door Sections only (.../FDG) (page 226)



Showing Push release Open/Close Mechanism

Storage

Combined Boardroom Storage Unit and Accessories

MFC:	Available in Ash, Autumn Cherry, Beech, Chester Oak, English Walnut, Grey, Grey Nebraska Oak, Laurentii Wenge, Natural Nebraska Oak and White
Nanotech:	Available in Black (2 Week Lead Time)
Veneer:	Available in Oak and Walnut (3 Week Lead Time)
Coloured:	Specific items available in Praline, Olive Green, Atlantic Blue, Sapphire Blue, Mustard Yellow, Terracotta and Conker Brown (2 Week Lead Time)
Edging:	Add surcharge for Wenge, Black and Plywood Effect per top - Edging on 25mm White MFC and Black Nanotech only



CSU7/5/D4



CSU7/6/D4



CSU7/5/D2

Combined Storage Unit

- Standard lead time.
- 25mm top panel.
- 2 / 3 / 4x soft close hinged door mechanisms.
- Lockable, includes 2x keys.
- 1000w and 1500w units supplied with 1 piece top and bottom.
- 2000w units supplied with 1 piece top and 2 piece bottom.
- Contrasting doors available on MFC and Black Nanotech only.
- Alternative handles available (page 222).
- Additional shelves available (see below).

4 Doors with 2x Adjustable Shelves

- CSU9/6/D4** - 2000w x 600d x 900h
- CSU9/5/D4** - 2000w x 500d x 900h

- CSU7/6/D4** - 2000w x 600d x 740h
- CSU7/5/D4** - 2000w x 500d x 740h

3 Doors with 2x Adjustable Shelves

- CSU9/6/D3** - 1500w x 600d x 900h
- CSU9/5/D3** - 1500w x 500d x 900h

- CSU7/6/D3** - 1500w x 600d x 740h
- CSU7/5/D3** - 1500w x 500d x 740h

2 Doors with 1x Adjustable Shelf

- CSU9/6/D2** - 1000w x 600d x 900h
- CSU9/5/D2** - 1000w x 500d x 900h

- CSU7/6/D2** - 1000w x 600d x 740h
- CSU7/5/D2** - 1000w x 500d x 740h

Finishes:	Standard MFC Contrasting Door Finish (.../CON) Add surcharge (on MFC) per door for Coloured MFC Contrasting Door Finish (.../CON) Add surcharge (on MFC) per door for Nanotech Contrasting Door Finish (.../CON) <i>Further information required, contact Customer Services for a specification form</i>
Handles:	Standard Handles Add surcharge per door for Push release Open/Close Mechanism (.../PH)
Additional:	Add surcharge per Fridge Cut-Out on 600d Double Door Sections only (.../FDG) (see below)



FLA7/6/D2/FDG1

Flare Boardroom and Combined Storage Unit Cut-Out for Fridge

- Standard lead time.
- Applies a cut-out to the chosen back section of the 600d Double Door Section of the unit only.
- Extra panels are added to divide the remaining internal space.
- To apply a fridge cut-out to the 600d Flare Boardroom and Combined Storage Units, suffix .../FDG to your chosen unit and refer to the '123' guide below.
- Section numbers always start from left-hand section.

- .../FDG1** - Cut-Out in Section 1 on 2, 3 and 4 Door Units
- .../FDG2** - Cut-Out in Section 2 on 2, 3 and 4 Door Units
- .../FDG3** - Cut-Out in Section 3 on 4 Door Units
- .../FDG4** - Cut-Out in Section 4 on 4 Door Units

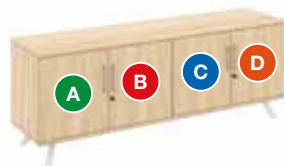

- A** Section 1
- B** Section 2
- C** Section 3
- D** Section 4



CSU/5/S/D2

Flare Boardroom and Combined Storage Unit Adjustable Shelves

- Standard lead time.

- CSU/5/S/D1** - For Single Section 3 Door 500d Units - 472w x 408d x 18h
- CSU/5/S/D2** - For 2 / 4 Door 500d Units - 963w x 408d x 18h
- CSU/5/S/D3** - For Double Section 3 Door 500d Units - 972w x 408d x 18h
- CSU/6/S/D1** - For Single Section 3 Door 600d Units - 472w x 508d x 18h
- CSU/6/S/D2** - For 2 / 4 Door 600d Units - 963w x 508d x 18h
- CSU/6/S/D3** - For Double Section 3 Door 600d Units - 972w x 508d x 18h

Storage

Desk High Storage

MFC: Available in Ash, Autumn Cherry, Beech, Chester Oak, English Walnut, Grey, Grey Nebraska Oak, Laurentii Wenge, Natural Nebraska Oak and White
Veneer: Available in Oak and Walnut (3 Week Lead Time)
Edging: Add surcharge for Wenge, Black and Plywood Effect per top - Edging on 25mm White MFC only



NSU12/5

Desk High Storage Unit

- Standard lead time.
- 25mm top panel.
- 2x sliding doors.
- 1600mm wide units with centre partition.
- Lockable, includes 2x keys.
- Alternative handles available (page 222).

NSU16/6 - 2x Adjustable Shelves - 1600w x 600d x 740h

NSU12/6 - 1x Adjustable Shelf - 1200w x 600d x 740h

NSU8/6 - 1x Adjustable Shelf - 800w x 600d x 740h

NSU16/5 - 2x Adjustable Shelves - 1600w x 500d x 740h

NSU12/5 - 1x Adjustable Shelf - 1200w x 500d x 740h

NSU8/5 - 1x Adjustable Shelf - 800w x 500d x 740h

NSU16/4 - 2x Adjustable Shelves - 1600w x 400d x 740h

NSU12/4 - 1x Adjustable Shelf - 1200w x 400d x 740h

NSU8/4 - 1x Adjustable Shelf - 800w x 400d x 740h



NSUZ16/6

Desk High Credenza Storage Unit

- Standard lead time.
- 25mm top panel.
- 2x sliding doors.
- Lockable, includes 2x keys.
- Ventilated on the left-hand side to accept NDS600 mini bar fridge (see below).
- Alternative handles available (page 222).

NSUZ16/6 - 1x Adjustable Shelf - 1600w x 600d x 740h

NSUZ12/6 - 1x Adjustable Shelf - 1200w x 600d x 740h



NDS600

Mini Bar Fridge

- Standard lead time.
- 1.6 cu.ft / 46 litre capacity.
- Energy rating of "A+".
- Sleek gloss white frame.
- Includes 1x shelf and a bottle rack.
- Noise level of 41 db (A).
- 1 year manufacturers warranty (must register with manufacturer upon purchase).

NDS600 - 472w x 450d x 492h



NSF2/6

Side Filing Unit

- Standard lead time.
- 25mm top panel.
- 2x filing drawers with built in anti-tilt mechanism.
- Foolsap filing.
- Lockable, includes 2x keys.
- Alternative handles available (page 222).

NSF2/6 - 800w x 600d x 740h

NSF2/5 - 800w x 500d x 740h



NSF2/6LH

Side Filing Unit with Overhanging Top

- Standard lead time.
- 25mm top panel.
- 220mm overhang.
- 2x filing drawers with built in anti-tilt mechanism.
- Foolsap filing.
- Lockable, includes 2x keys.
- Alternative handles available (page 222).
- Optional CPU Holder available (page 316).

NSF2/6... (LH or RH) - 1020w x 600d x 740h

Storage

Desk High and Desktop Storage and Plan Chests

MFC: Available in Ash, Autumn Cherry, Beech, Chester Oak, English Walnut, Grey, Grey Nebraska Oak, Laurentii Wenge, Natural Nebraska Oak and White
Veneer: Available in Oak and Walnut (3 Week Lead Time)
Edging: Add surcharge for Wenge, Black and Plywood Effect per top - Edging on 25mm White MFC only



NOSU12/5

Open Fronted Desk High Storage Unit

- Standard lead time. • 25mm top panel.

NOSU12/6 - 1x Adjustable Shelf - 1200w x 600d x 740h

NOSU12/5 - 1x Adjustable Shelf - 1200w x 500d x 740h

NOSU12/4 - 1x Adjustable Shelf - 1200w x 400d x 740h



NSSC10

Storage Unit

- Standard lead time. • 25mm top panel. • 2x hinged doors. • Lockable, includes 2x keys.
- Alternative handles available (page 222).

NSSC10 - 1x Adjustable Shelf - 1060w x 500d x 740h



TCGH

Glass Fronted Desktop Storage Unit with Hinged Doors

- Standard lead time. • 25mm top panel. • 2x 4mm toughened glass hinged doors.
- Lockable, includes 2x keys. • Alternative handles available (page 222).
- Suitable for NSSC10 (see above).

TCGH - 1x Adjustable Shelf - 1060w x 330d x 875h



TC12

Open Fronted Desktop Storage Unit

- Standard lead time. • 25mm top panel.

TC12 - 1x Adjustable Shelf - 1200w x 356d x 725h

TC8 - 1x Adjustable Shelf - 800w x 356d x 725h



PC8A0

A0 Plan Chest

- Standard lead time. • 18mm top panel. • Available with 8x, 6x, 3x or 1x drawers.
- Will accommodate paper size A0 (1189mm x 841mm). • Alternative handles available (page 222).

PC8A0 - 8x Drawers - 1340w x 960d x 830h

PC6A0 - 6x Drawers - 1340w x 960d x 830h

PC3A0 - 3x Drawers - 1340w x 960d x 830h

PC1A0 - 1x Drawer - 1340w x 960d x 830h



PC8A1

A1 Plan Chest

- Standard lead time. • 18mm top panel. • Available with 8x, 6x, 3x or 1x drawers.
- Will accommodate paper size A1 (841mm x 594mm). • Alternative handles available (page 222).

PC8A1 - 8x Drawers - 992w x 707d x 830h

PC6A1 - 6x Drawers - 992w x 707d x 830h

PC3A1 - 3x Drawers - 992w x 707d x 830h

PC1A1 - 1x Drawer - 992w x 707d x 830h

Storage

Planter Storage Unit and Storage Planter Boxes

MFC: Available in Ash, Autumn Cherry, Beech, Chester Oak, English Walnut, Grey, Grey Nebraska Oak, Laurentii Wenge, Natural Nebraska Oak and White
Coloured MFC: Available in Praline, Olive Green, Atlantic Blue, Sapphire Blue, Mustard Yellow, Terracotta and Conker Brown (2 Week Lead Time)
Nanotech: Available in Black (3 Week Lead Time)
Edging: Add surcharge for Wenge, Black and Plywood Effect per top - Edging on 25mm White MFC and Black Nanotech only



NSU8/4/P

Planter Storage Unit

- Standard lead time.
- This unit is supplied without plants, plant tray or liner.
- 2x sliding doors.
- Open display shelf.
- Recessed planter bed within top section of the storage unit.
- Lockable, includes 2x keys.
- Alternative handles available (page 222).
- 764w x 356d x 174h internal dimensions.
- The units require a waterproof membrane liner to protect against moisture and water ingress.
- Artificial, decorative plants available, contact sales for details.

NSU8/4/P - 1x Adjustable Shelf - 800w x 400d x 1266h



SPB15/5

Storage Planter Boxes

- Standard lead time.
- This unit is supplied without plants, plant tray or liner.
- Retro-fittable planter bed.
- Internal dimensions are w-36 x d-36 x h-18.
- Planters are 170h.
- The units require a waterproof membrane liner to protect against moisture and water ingress.
- Artificial, decorative plants available, contact sales for details.

SPB20/6 - For use with 2000w and 600d Flare and Combined Units
SPB15/6 - For use with 1500w and 600d Flare and Combined Units
SPB10/6 - For use with 1000w and 600d Flare and Combined Units



SPB12/6

SPB20/5 - For use with 2000w and 500d Flare and Combined Units
SPB15/5 - For use with 1500w and 500d Flare and Combined Units
SPB10/5 - For use with 1000w and 500d Flare and Combined Units

SPB16/6 - For use with NSU16/6
SPB12/6 - For use with NSU12/6
SPB8/6 - For use with NSU8/6



SPB12/5

SPB16/5 - For use with NSU16/5 and NML/TB4
SPB12/5 - For use with NSU12/5 and NML/TB3
SPB8/5 - For use with NSU8/5 and NML/TB2
SPB4/5 - For use with NML/TB1

SPB16/4 - For use with NSU16/4
SPB12/4 - For use with NSU12/4
SPB8/4 - For use with NSU8/4 and SC7



SPB105/5

SPB105/5 - For use with NSSC Tambours

SPB99/5 - For use with NSSC Cupboards



SPB99/5



Storage

Desk High Storage

MFC: Available in Ash, Autumn Cherry, Beech, Chester Oak, English Walnut, Grey, Grey Nebraska Oak, Laurentii Wenge, Natural Nebraska Oak and White
Veneer: Available in Oak and Walnut (3 Week Lead Time)
Edging: Add surcharge for Wenge, Black and Plywood Effect per top - Edging on 25mm White MFC only



OSUD16/6

Desk High Combi Storage Unit

- Standard lead time.
- 25mm top panel.
- Combination unit comprising of 2x 4 drawer units and open fronted storage.
- Lockable, includes 2x keys.
- Alternative handles available (page 222).

2x 4x Single Drawers and 1x Adjustable Shelf

OSUD16/6 - 1600w x 600d x 740h



SU8X8

90 Degree Desk High Storage Unit

- Standard lead time.
- 25mm top panel.
- Open fronted.
- Accepts 2x rows of A4 ring binders.

SU8X8 - 1x Shelf - 800w x 800d x 740h

SU6X6 - 1x Shelf - 600w x 600d x 740h



SU8X8ST

90 Degree Desk High Tambour Storage Unit

- Standard lead time.
- 25mm top panel.
- 2x side opening tambour doors.
- Accepts 2x rows of A4 ring binders.
- Alternative handles available (page 222).

Silver Blinds

SU8X8ST - 1x Shelf - 800w x 800d x 740h

White Blinds

SU8X8ST/W - 1x Shelf - 800w x 800d x 740h



SU8X8ST/W



Storage

Filing Cabinets

MFC: Available in Ash, Autumn Cherry, Beech, Chester Oak, English Walnut, Grey, Grey Nebraska Oak, Laurentii Wenge, Natural Nebraska Oak and White
Veneer: Available in Oak and Walnut (3 Week Lead Time)
Edging: Add surcharge for Wenge, Black and Plywood Effect per top - Edging on 25mm White MFC only



FC2

2 Drawer Filing Cabinet

- Standard lead time.
- 25mm top panel.
- Central locking with anti-tilt mechanism.
- Foolscape filing.
- Alternative handles available (page 222).

2x Filing Drawers

FC2 - 466w x 600d x 740h



FC3

3 Drawer Filing Cabinet

- Standard lead time.
- 25mm top panel.
- Central locking with anti-tilt mechanism.
- Foolscape filing.
- Alternative handles available (page 222).

3x Filing Drawers

FC3 - 466w x 600d x 1069h



FC4

4 Drawer Filing Cabinet

- Standard lead time.
- 25mm top panel.
- Central locking with anti-tilt mechanism.
- Foolscape filing.
- Alternative handles available (page 222).

4x Filing Drawers

FC4 - 466w x 600d x 1398h



Storage

New Style Bookcases and Storage Units

MFC: Available in Ash, Autumn Cherry, Beech, Chester Oak, English Walnut, Grey, Grey Nebraska Oak, Laurentii Wenge, Natural Nebraska Oak and White
Veneer: Available in Oak and Walnut (3 Week Lead Time)
Edging: Add surcharge for Wenge, Black and Plywood Effect per top - Edging on 25mm White MFC only



NBS18

New Style Bookcase

- Standard lead time.
- 25mm top panel.
- Delivered unassembled.
- Additional shelves available (see below).

NBS20	- 5x Adjustable Shelves	- 800w x 320d x 2000h
NBS18	- 4x Adjustable Shelves	- 800w x 320d x 1800h
NBS16	- 4x Adjustable Shelves	- 800w x 320d x 1600h
NBS12	- 3x Adjustable Shelves	- 800w x 320d x 1200h
NBS10	- 2x Adjustable Shelves	- 800w x 320d x 1000h
NBS7	- 1x Adjustable Shelf	- 800w x 320d x 740h

Additional Adjustable Shelves

NBS - For Bookcases and NSC7-NSC20 Units - 763w x 294d x 18h



NSC18

New Style Storage Unit

- Standard lead time.
- 25mm top panel.
- 400mm deep.
- 2x hinged doors.
- Lockable, includes 2x keys.
- Alternative handles available (page 222).
- Additional shelves available (see below).

NSC20	- 4x Adjustable Shelves	- 800w x 400d x 2000h
NSC18	- 3x Adjustable Shelves	- 800w x 400d x 1800h
NSC16	- 3x Adjustable Shelves	- 800w x 400d x 1600h
NSC12	- 2x Adjustable Shelves	- 800w x 400d x 1200h
NSC7	- 1x Adjustable Shelf	- 800w x 400d x 740h

Additional Adjustable Shelves

NBS - For Bookcases and NSC7-NSC20 Units - 763w x 294d x 18h



Storage

Storage Units and Accessories

MFC: Available in Ash, Autumn Cherry, Beech, Chester Oak, English Walnut, Grey, Grey Nebraska Oak, Laurentii Wenge, Natural Nebraska Oak and White
Veneer: Available in Oak and Walnut (3 Week Lead Time)
Edging: Add surcharge for Wenge, Black and Plywood Effect per top - Edging on 25mm White MFC only



NSSC18

System Storage Unit

- Standard lead time.
- 25mm top panel.
- 500mm and 600mm deep.
- 2x hinged doors.
- Lockable, includes 2x keys.
- Carcase only.
- Alternative handles available (page 222).
- Additional shelves available (see below).
- Skins and fitted wardrobe kit available (see below).

NSSC20 - 990w x 500d x 2000h

NSSC18 - 990w x 500d x 1800h

NSSC16 - 990w x 500d x 1600h

NSSC12 - 990w x 500d x 1200h

NSSC7 - 990w x 500d x 740h

NSSC7/6 - 990w x 600d x 740h

Additional Adjustable Shelves

NSSC - For 500d NSSC Units - 950w x 408d x 18h

NSSC7/6S - For 600d NSSC7/6 Units - 950w x 500d x 18h



SSU/CR99/5

System Storage Unit Clothes Rail

- Standard lead time.
- Complete with hanging rail and single shelf.
- Compatible with system storage units (see above).

SSU/CR99/5 - 1x Clothes Rail and 1x Shelf - For NSSC20 and NSSC18 Units



NFWK18

System Storage Unit Fitted Wardrobe Kit

- Standard lead time.
- Complete with hanging rail.
- Compatible with system storage units (see above).

NFWK20 - 4x Adjustable Shelves - For NSSC20 Units

NFWK18 - 4x Adjustable Shelves - For NSSC18 Units



BTS18

System Storage Unit Skins

- Standard lead time.
- Adapts system storage units (see above) to accept Elite internals (page 236).

BTS20 - For NSSC20 Units

BTS18 - For NSSC18 Units

BTS16 - For NSSC16 Units

BTS12 - For NSSC12 Units

BTS7 - For 740h NSSC Units

Storage

Storage Units

MFC: Available in Ash, Autumn Cherry, Beech, Chester Oak, English Walnut, Grey, Grey Nebraska Oak, Laurentii Wenge, Natural Nebraska Oak and White
Veneer: Available in Oak and Walnut (3 Week Lead Time)
Edging: Add surcharge for Wenge, Black and Plywood Effect per top - Edging on 25mm White MFC only



NSSC18ST



NSSC18ST/W

System Tambour Storage Unit

- Standard lead time.
- 25mm top panel.
- 500mm deep.
- 2x side opening silver or white blinds on tambour doors.
- Lockable, includes 2x keys.
- Complete with system storage unit skins.
- Alternative handles available (page 222).
- Additional shelves available (page 236).

Silver Blinds

- NSSC20ST** - 1050w x 500d x 2000h
- NSSC18ST** - 1050w x 500d x 1800h
- NSSC16ST** - 1050w x 500d x 1600h
- NSSC12ST** - 1050w x 500d x 1200h
- NSSC7ST** - 1050w x 500d x 740h

White Blinds

- NSSC20ST/W** - 1050w x 500d x 2000h
- NSSC18ST/W** - 1050w x 500d x 1800h
- NSSC16ST/W** - 1050w x 500d x 1600h
- NSSC12ST/W** - 1050w x 500d x 1200h
- NSSC7ST/W** - 1050w x 500d x 740h



System Tambour Storage Unit

- Standard lead time.
- 25mm top panel.
- 600mm deep.
- 2x side opening silver or white blinds on tambour doors.
- Lockable, includes 2x keys.
- Complete with system storage unit skins.
- Alternative handles available (page 222).
- Additional shelves available (page 236).

Silver Blinds

- NSSC7/6ST** - 1050w x 600d x 740h

White Blinds

- NSSC7/6ST/W** - 1050w x 600d x 740h



NSSC7/6ST



NSSC7/6ST/W

Storage

Steel Storage

6 Weeks Lead Time

MFC: Available in Ash, Autumn Cherry, Beech, Chester Oak, English Walnut, Grey, Grey Nebraska Oak, Laurentii Wenge, Natural Nebraska Oak and White
Veneer: Available in Oak and Walnut (*3 Week Lead Time*)
Edging: Add surcharge for Wenge, Black and Plywood Effect per top - *Edging on 25mm White MFC only*
Metalwork: Silver (no suffix), Black AV1 (.../B) and White BC3 (.../W)



SYT10/54

Elite Steel Systemfile Tambour Storage Unit

- 6 week lead time.
- Locking doors.
- Additional MFC top available (see below).
- 10 year guarantee.

2x Tambour Doors

- SYT10/6** - 1000w x 470d x 1947h
- SYT10/54** - 1000w x 470d x 1795h
- SYT10/50** - 1000w x 470d x 1643h
- SYT10/34** - 1000w x 470d x 1149h
- SYT10/3** - 1000w x 470d x 997h
- SYT10/2** - 1000w x 470d x 693h

Finishes: Silver (no suffix), Black AV1 (.../B) and White BC3 (.../W)



ESSMFCT10

Elite Systemfile MFC Top

- Standard lead time.
- 25mm top panel.
- MFC top for all Elite systemfile items.
- Supplied loose with adhesive pads.
- Increases storage height by 25mm.

- ESSMFCT10** - 1000w x 470d x 25h
- ESSMFCT8** - 800w x 470d x 25h

Storage

Accessories



BIT10BSPS

Standard Shelf

- Standard lead time.
- Single shelf.
- Requires system storage unit skins.

BIT10BSPS



BIT10RSPS

Pull Out Reference Shelf

- Standard lead time.
- Single shelf.
- Requires system storage unit skins.

BIT10RSPS



BIT10SSPDPS and SHDV65P5PS

Slotted Filing Shelf with Dividers

- Standard lead time.
- Single shelf.
- 5x dividers.
- Requires system storage unit skins.

BIT10SSPDPS - Slotted Filing Shelf Only

SHDV65P5PS - 5x Dividers Only



BIT10LRPS

Lateral Filing Cradle

- Standard lead time.
- Adjustable lateral filing cradle, between 190mm and 330mm centres.
- Requires system storage unit skins.

BIT10LRPS



BIT10RFAPS

Pull Out Vertical Filing Cradle

- Standard lead time.
- Complete with 2x cross bars to accept foolscap filing side on.
- Standard foolscap and A4 filing front to back.
- Requires system storage unit skins.

BIT10RFAPS



BIT10RDAPS

Pull Out Vertical Drawer

- Standard lead time.
- Drawer is 100mm deep.
- Requires system storage unit skins.

BIT10RDAPS

Storage

Accessories



	Quantity of Vertical Rows A4 Box File - 265w x 75d x 337h	Quantity of Vertical Rows Footscap Box File - 265w x 75d x 368h	Quantity of Vertical Rows A4 Lever Arch File - 280w x 75d x 318h	Quantity of Vertical Rows Footscap Lever Arch File - 285w x 75d x 350h
Bookcase - NBS20	5	4	5	4
Bookcase - NBS18	4	4	4	4
Bookcase - NBS16	4	3	4	3
Bookcase - NBS12	2	2	3	2
Bookcase - NBS10	2	2	2	2
Bookcase - NBS7	1	1	1	1
Storage Unit - NSC20	5	4	5	4
Storage Unit - NSC18	4	4	4	4
Storage Unit - NSC16	3	3	4	3
Storage Unit - NSC12	2	2	3	2
Storage Unit - NSC7	1	1	1	1
System Storage Unit - NSSC20	5	4	5	5
System Storage Unit - NSSC18	4	4	4	4
System Storage Unit - NSSC16	4	3	4	3
System Storage Unit - NSSC12	3	2	3	2
System Storage Unit - NSSC7 and NSSC7/6	1	1	1	1
System Tambour Storage Unit - NSSC20ST	5	4	5	5
System Tambour Storage Unit - NSSC18ST	4	4	4	4
System Tambour Storage Unit - NSSC16ST	4	3	4	4
System Tambour Storage Unit - NSSC12ST	3	2	3	2
System Tambour Storage Unit - NSSC7ST and NSSC7/6ST	1	1	1	1

Storage

Cubeform



Storage

Cubeform

MFC: Available in Ash, Autumn Cherry, Beech, Chester Oak, English Walnut, Grey, Grey Nebraska Oak, Laurentii Wenge, Natural Nebraska Oak and White
Nanotech: Available in Black (2 Week Lead Time)
Metalwork: Silver, Black Graphite and White - Add surcharge for Raw
Add surcharge for Praline, Olive Green, Atlantic Blue, Sapphire Blue, Mustard Yellow, Terracotta and Conker Brown (2 Week Lead Time)



CF/PCS45

Cubeform Pre-Configured Structures - 4 by 5

- Standard lead time.
- Includes feet.
- Each standard cube measures 425w x 425h x 400d.
- Extra Cubeform Vertical Frames and Shelves can be added to this item.

CF/PCS45 - 1825w x 400d x 2280h



CF/PCS35

Cubeform Pre-Configured Structures - 3 by 5

- Standard lead time.
- Includes feet.
- Each standard cube measures 425w x 425h x 400d.
- Extra Cubeform Vertical Frames and Shelves can be added to this item.

CF/PCS35 - 1375w x 400d x 2280h



CF/PCS25

Cubeform Pre-Configured Structures - 2 by 5

- Standard lead time.
- Includes feet.
- Each standard cube measures 425w x 425h x 400d.
- Extra Cubeform Vertical Frames and Shelves can be added to this item.

CF/PCS25 - 925w x 400d x 2280h



CF/PCS44

Cubeform Pre-Configured Structures - 4 by 4

- Standard lead time.
- Includes feet.
- Each standard cube measures 425w x 425h x 400d.
- Extra Cubeform Vertical Frames and Shelves can be added to this item.

CF/PCS44 - 1825w x 400d x 1830h



CF/PCS34

Cubeform Pre-Configured Structures - 3 by 4

- Standard lead time.
- Includes feet.
- Each standard cube measures 425w x 425h x 400d.
- Extra Cubeform Vertical Frames and Shelves can be added to this item.

CF/PCS34 - 1375w x 400d x 1830h



CF/PCS24

Cubeform Pre-Configured Structures - 2 by 4

- Standard lead time.
- Includes feet.
- Each standard cube measures 425w x 425h x 400d.
- Extra Cubeform Vertical Frames and Shelves can be added to this item.

CF/PCS24 - 925w x 400d x 1830h

Storage

Cubeform

MFC: Available in Ash, Autumn Cherry, Beech, Chester Oak, English Walnut, Grey, Grey Nebraska Oak, Laurentii Wenge, Natural Nebraska Oak and White
Nanotech: Available in Black (2 Week Lead Time)
Metalwork: Silver, Black Graphite and White - Add surcharge for Raw
Add surcharge for Praline, Olive Green, Atlantic Blue, Sapphire Blue, Mustard Yellow, Terracotta and Conker Brown (2 Week Lead Time)



CF/PCS43

Cubeform Pre-Configured Structures - 4 by 3

- Standard lead time.
- Includes feet.
- Each standard cube measures 425w x 425h x 400d.
- Extra Cubeform Vertical Frames and Shelves can be added to this item.

CF/PCS43 - 1825w x 400d x 1380h



CF/PCS33

Cubeform Pre-Configured Structures - 3 by 3

- Standard lead time.
- Includes feet.
- Each standard cube measures 425w x 425h x 400d.
- Extra Cubeform Vertical Frames and Shelves can be added to this item.

CF/PCS33 - 1375w x 400d x 1380h



CF/PCS23

Cubeform Pre-Configured Structures - 2 by 3

- Standard lead time.
- Includes feet.
- Each standard cube measures 425w x 425h x 400d.
- Extra Cubeform Vertical Frames and Shelves can be added to this item.

CF/PCS23 - 925w x 400d x 1380h



CF/PCS42

Cubeform Pre-Configured Structures - 4 by 2

- Standard lead time.
- Includes feet.
- Each standard cube measures 425w x 425h x 400d.
- Extra Cubeform Vertical Frames and Shelves can be added to this item.

CF/PCS42 - 1825w x 400d x 930h



CF/PCS32

Cubeform Pre-Configured Structures - 3 by 2

- Standard lead time.
- Includes feet.
- Each standard cube measures 425w x 425h x 400d.
- Extra Cubeform Vertical Frames and Shelves can be added to this item.

CF/PCS32 - 1375w x 400d x 930h



CF/PCS22

Cubeform Pre-Configured Structures - 2 by 2

- Standard lead time.
- Includes feet.
- Each standard cube measures 425w x 425h x 400d.
- Extra Cubeform Vertical Frames and Shelves can be added to this item.

CF/PCS22 - 925w x 400d x 930h

Storage

How to Specify Cubeform

How to Specify Cubeform

Vertical Frame

The code is for a Single Vertical Frame that is represented by a full uninterrupted orange vertical line. These Vertical Frames will be joined together when Shelves are specified.

Cubeforms specified 1 cube wide can be 1 or 2 cubes high only.

To create a configuration 2 cubes wide, 3 Vertical Frames are required, to create a configuration 3 cubes wide, 4 Vertical Frames are required, and so on.

These can be used on standard or corner configurations.

The Vertical Frames are represented in orange.

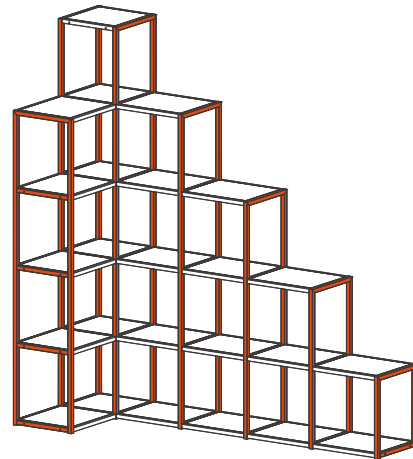

Shelves

The code is for shelves that are represented by the uninterrupted orange and blue horizontal lines. The Shelves also connect the Vertical Frames together at regular intervals on the unit. These provide the structural link for the overall unit.

Standard and Corner shelves must be specified separately.

The Standard shelves are represented in orange and the Corner shelves are represented in blue.

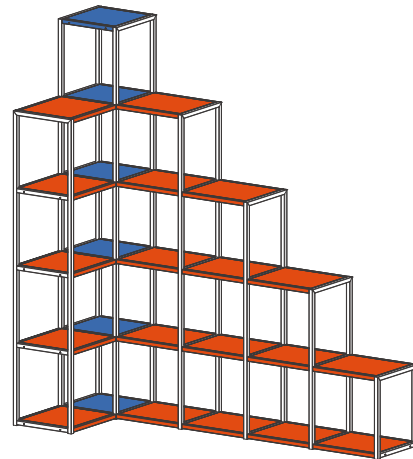

Accessories

A range of optional accessories are compatible with Cubeform delivering a number of flexible storage solutions.

All accessories can be retro-fitted.

Specific items have the option of different back styles. This includes a standard back, magnetic whiteboard back or fabric back.



No Suffix
Standard Back



.../WB
Magnetic Whiteboard Back Panel



.../FB
Fabric Back

Storage

Cubeform

MFC: Available in Ash, Autumn Cherry, Beech, Chester Oak, English Walnut, Grey, Grey Nebraska Oak, Laurentii Wenge, Natural Nebraska Oak and White
Nanotech: Available in Black (2 Week Lead Time)
Metalwork: Silver, Black Graphite and White - Add surcharge for Raw
Add surcharge for Praline, Olive Green, Atlantic Blue, Sapphire Blue, Mustard Yellow, Terracotta and Conker Brown (2 Week Lead Time)

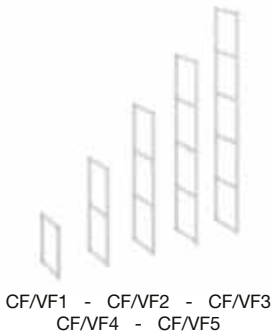

Cubeform Vertical Frame - Floor Standing

- Shelves are required with this product (see below).
- Standard lead time. • Includes feet. • If only 1 column is required, unit must be 1 or 2 sections high only.
- 3x Vertical Frames are required for the first 2 columns. • 1x Vertical Frame is required for all subsequent columns.
- Each standard cube measures 425w x 425h x 400d. • Each corner cube measures 350w x 425h x 400d.

CF/VF5 - 5 Sections High - Floor Standing - 25w x 400d x 2280h - Minimum 2 Columns Wide
CF/VF4 - 4 Sections High - Floor Standing - 25w x 400d x 1830h - Minimum 2 Columns Wide
CF/VF3 - 3 Sections High - Floor Standing - 25w x 400d x 1380h - Minimum 2 Columns Wide
CF/VF2 - 2 Sections High - Floor Standing - 25w x 400d x 930h - Minimum 2 Columns Wide
CF/VF1 - 1 Section High - Floor Standing - 25w x 400d x 480h - Minimum 2 Columns Wide

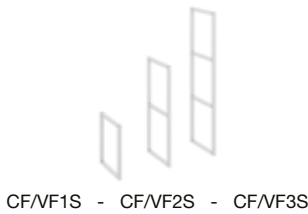

Cubeform Vertical Frame - Suspended

- Shelves are required with this product (see below).
- Standard lead time. • Does not include feet. • To be used between Floor Standing Vertical Frames only.
- Maximum of 2x Suspended Vertical Frames to be specified side by side.
- Each standard cube measures 425w x 425h x 400d. • Each corner cube measures 350w x 425h x 400d.

CF/VF3S - 3 Sections High - Suspended - 25w x 400d x 1375h
CF/VF2S - 2 Sections High - Suspended - 25w x 400d x 925h
CF/VF1S - 1 Section High - Suspended - 25w x 400d x 475h

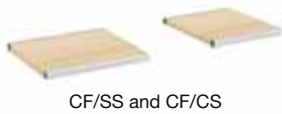

Cubeform Shelf

- Vertical Frames are required with this product (see above).
- Standard lead time. • 18mm top panel. • 1x Shelf per level is required for all columns including the bases.
- Acts as structural support for the Cubeform frame.
- Each standard cube measures 425w x 425h x 400d.
- Each corner cube measures 350w x 425h x 400d.

CF/SS - Standard Shelf - 425w x 395d x 25h
CF/CS - Corner Shelf - 350w x 395d x 25h



CF/EFCC/BGR

Cubeform End Frame Cover Caps

- Standard lead time. • Fills exposed flow drill holes on the ends of the framework.

CF/EFCC/S - Silver - Sold in Packs of 24
CF/EFCC/BGR - Black Graphite - Sold in Packs of 24
CF/EFCC/WH - White - Sold in Packs of 24



CF/EFCC...



CF/BKT

Cubeform Bracket for Back to Back Units

- Required on back to back structures, 2x columns wide only. • Not needed for standard Cubeform Structures.
- Standard lead time. • Connects 2x Cubeform structures to increase stability on deeper versions.
- Brackets placed at either end of the Cubeform structure.

CF/BKT - Bracket - Sold in Pairs

Storage

Cubeform

MFC:	Available in Ash, Autumn Cherry, Beech, Chester Oak, English Walnut, Grey, Grey Nebraska Oak, Laurentii Wenge, Natural Nebraska Oak and White
Coloured MFC:	Available in Praline, Olive Green, Atlantic Blue, Sapphire Blue, Mustard Yellow, Terracotta and Conker Brown (2 Week Lead Time)
Nanotech:	Available in Black (2 Week Lead Time)
Metalwork:	Silver, Black Graphite and White - Add surcharge for Raw Add surcharge for Praline, Olive Green, Atlantic Blue, Sapphire Blue, Mustard Yellow, Terracotta and Conker Brown (2 Week Lead Time)



CF/NSC32
Storage Unit / Shelf Only



CF/NSC22
Storage Unit / Shelf Only



CF/NSC12
Storage Unit / Shelf Only

Cubeform Single Sided Storage Unit

- Storage Unit / Shelf only, Cubeform structure needs to be specified separately.
- Mandatory Shelves need to be quoted along with Storage Units. • Shelves can also be used when specifying a Bridging Cube and Floor Standing Storage Unit, and a Vertical Frame is not viable.
- Standard lead time. • For use on straight structures only. • 400mm deep. • 1x or 2x hinged doors.
- Push release open/close mechanism. • Relevant shelf required for support.

CF/NSC32 - To fit within 3 Sections Wide and 2 Sections High
1325w x 400d x 875h

CF/SS3 - **Mandatory for the Above Unit** - Shelf for 3 Sections Wide
1325w x 400d x 25h

CF/NSC22 - To fit within 2 Sections Wide and 2 Sections High
875w x 400d x 875h

CF/SS2 - **Mandatory for the Above Unit** - Shelf for 2 Sections Wide
875w x 400d x 25h

CF/NSC12 - To fit within 1 Section Wide and 2 Sections High
425w x 400d x 875h

CF/SS1 - **Mandatory for the Above Unit** - Shelf for 1 Sections Wide
425w x 400d x 25h



Storage

Cubeform

- MFC:** Available in Ash, Autumn Cherry, Beech, Chester Oak, English Walnut, Grey, Grey Nebraska Oak, Laurentii Wenge, Natural Nebraska Oak and White
- Coloured MFC:** Available in Praline, Olive Green, Atlantic Blue, Sapphire Blue, Mustard Yellow, Terracotta and Conker Brown (2 Week Lead Time)
- Nanotech:** Available in Black (2 Week Lead Time)
- Metalwork:** Silver, Black Graphite and White - Add surcharge for Raw
Add surcharge for Praline, Olive Green, Atlantic Blue, Sapphire Blue, Mustard Yellow, Terracotta and Conker Brown (2 Week Lead Time)

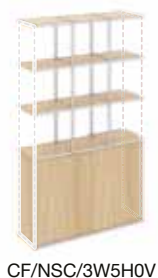
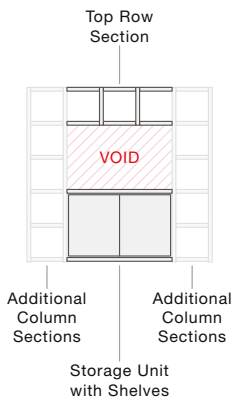
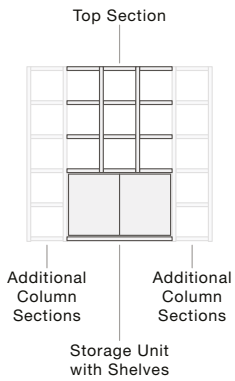

Cubeform Single Sided Storage Unit Structure

- Storage Unit Structures require 1x or more additional column sections (using standard or corner shelves) on both sides of the structure for support.
- When a structure includes a void, it will have 1x row section only across the top of the structure.
- Void rows are situated directly underneath the above single row section.
- When a structure includes a void, the top row of this unit is not compatible with associated storage cubes.
- Standard lead time.
- Storage Units are 400mm deep.
- 1x or 2x hinged doors.
- Push release open/close mechanism.
- Additional items are required to complete this Cubeform structure.
- Complete structure uses a mixture of shelves and vertical frames to create the Storage Unit Structure.
- Includes feet.
- Each standard cube measures 425w x 425h x 400d.

1 Section Wide

CF/NSC/1W2H0V	- 2 Sections High	- 0 Void Rows	- 425w x 400d x 930h
CF/NSC/1W3H0V	- 3 Sections High	- 0 Void Rows	- 425w x 400d x 1380h
CF/NSC/1W4H0V	- 4 Sections High	- 0 Void Rows	- 425w x 400d x 1830h
CF/NSC/1W5H0V	- 5 Sections High	- 0 Void Rows	- 425w x 400d x 2280h
CF/NSC/1W5H2V	- 5 Sections High	- 2 Void Rows	- 425w x 400d x 2280h

2 Sections Wide

CF/NSC/2W2H0V	- 2 Sections High	- 0 Void Rows	- 875w x 400d x 930h
CF/NSC/2W3H0V	- 3 Sections High	- 0 Void Rows	- 875w x 400d x 1380h
CF/NSC/2W4H0V	- 4 Sections High	- 0 Void Rows	- 875w x 400d x 1830h
CF/NSC/2W4H1V	- 4 Sections High	- 1 Void Row	- 875w x 400d x 1830h
CF/NSC/2W5H0V	- 5 Sections High	- 0 Void Rows	- 875w x 400d x 2280h
CF/NSC/2W5H2V	- 5 Sections High	- 2 Void Rows	- 875w x 400d x 2280h

3 Sections Wide

CF/NSC/3W2H0V	- 2 Sections High	- 0 Void Rows	- 1325w x 400d x 930h
CF/NSC/3W3H0V	- 3 Sections High	- 0 Void Rows	- 1325w x 400d x 1380h
CF/NSC/3W4H0V	- 4 Sections High	- 0 Void Rows	- 1325w x 400d x 1830h
CF/NSC/3W4H1V	- 4 Sections High	- 1 Void Row	- 1325w x 400d x 1830h
CF/NSC/3W5H0V	- 5 Sections High	- 0 Void Rows	- 1325w x 400d x 2280h
CF/NSC/3W5H2V	- 5 Sections High	- 2 Void Rows	- 1325w x 400d x 2280h



Storage

Cubeform

MFC: Available in Ash, Autumn Cherry, Beech, Chester Oak, English Walnut, Grey, Grey Nebraska Oak, Laurentii Wenge, Natural Nebraska Oak and White
Nanotech: Available in Black (2 Week Lead Time)
Metalwork: Silver, Black Graphite and White - Add surcharge for Raw
 Add surcharge for Praline, Olive Green, Atlantic Blue, Sapphire Blue, Mustard Yellow, Terracotta and Conker Brown (2 Week Lead Time)



CF/BC4
Illustrated in red



CF/BC3
Illustrated in red



CF/BC2
Illustrated in red



CF/BC1
Illustrated in red

Cubeform Bridging Cube

- This unit is not compatible with associated storage cubes, standard shelf only.
- Standard lead time. • 18mm top panels. • Allows a connection between 2 tall Cubeform Structures.
- Uses a mixture of shelves and vertical frames to create the Bridging Cube.

CF/BC4 - 4 Sections Wide - Creates 1775w x 875h Void - 1775w x 400d x 475h
CF/BC3 - 3 Sections Wide - Creates 1325w x 875h Void - 1325w x 400d x 475h
CF/BC2 - 2 Sections Wide - Creates 875w x 875h Void - 875w x 400d x 475h
CF/BC1 - 1 Section Wide - Creates 425w x 875h Void - 425w x 400d x 475h



CF/SS2

Cubeform Extended Shelf

- For use when specifying a Bridging Cube and Floor Standing Storage Unit and a Vertical Frame is not viable.
- Vertical Frames are required either side of this product (page 246).
- Standard lead time. • 18mm top panel. • Acts as structural support for the Cubeform frame.

CF/SS3 - Standard Shelf - 3 Sections Wide - 1325w x 395d x 25h
CF/SS2 - Standard Shelf - 2 Sections Wide - 875w x 395d x 25h

Storage

Cubeform

MFC: Available in Ash, Autumn Cherry, Beech, Chester Oak, English Walnut, Grey, Grey Nebraska Oak, Laurentii Wenge, Natural Nebraska Oak and White
Nanotech: Available in Black (2 Week Lead Time)
Metalwork: Silver, Black Graphite and White - Add surcharge for Raw
 Add surcharge for Praline, Olive Green, Atlantic Blue, Sapphire Blue, Mustard Yellow, Terracotta and Conker Brown (2 Week Lead Time)

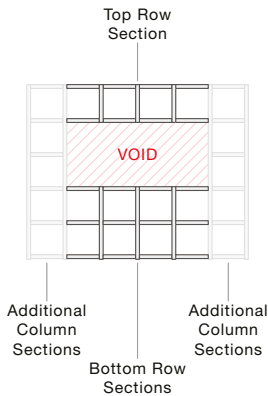

Cubeform Bridging Cube Structure

- Bridging Cube Structures require 1x or more additional column sections (using standard or corner shelves) on both sides of the structure for support.
- Each Bridging Cube Structure has 1x row section only across the top of the structure.
- Void rows are situated directly underneath the above single row section.
- The top row of this unit is not compatible with associated storage cubes.
- Standard lead time.
- Additional items are required to complete this Cubeform structure.
- Complete structure uses a mixture of shelves and vertical frames to create the Bridging Cube Structure.
- Includes feet.
- Each standard cube measures 425w x 425h x 400d.

1 Section Wide

CF/CB/1W4H2V	- 4 Sections High	- 2 Void Rows (425w x 875h)	- 425w x 400d x 1830h
CF/CB/1W5H2V	- 5 Sections High	- 2 Void Rows (425w x 875h)	- 425w x 400d x 2280h
CF/CB/1W5H3V	- 5 Sections High	- 3 Void Rows (425w x 1325h)	- 425w x 400d x 2280h

2 Sections Wide

CF/CB/2W3H1V	- 3 Sections High	- 1 Void Row (875w x 425h)	- 875w x 400d x 1380h
CF/CB/2W4H1V	- 4 Sections High	- 1 Void Row (875w x 425h)	- 875w x 400d x 1830h
CF/CB/2W4H2V	- 4 Sections High	- 2 Void Rows (875w x 875h)	- 875w x 400d x 1830h
CF/CB/2W5H1V	- 5 Sections High	- 1 Void Row (875w x 425h)	- 875w x 400d x 2280h
CF/CB/2W5H2V	- 5 Sections High	- 2 Void Rows (875w x 875h)	- 875w x 400d x 2280h
CF/CB/2W5H3V	- 5 Sections High	- 3 Void Rows (875w x 1325h)	- 875w x 400d x 2280h

3 Sections Wide

CF/CB/3W3H1V	- 3 Sections High	- 1 Void Row (1325w x 425h)	- 1325w x 400d x 1380h
CF/CB/3W4H1V	- 4 Sections High	- 1 Void Row (1325w x 425h)	- 1325w x 400d x 1830h
CF/CB/3W4H2V	- 4 Sections High	- 2 Void Rows (1325w x 875h)	- 1325w x 400d x 1830h
CF/CB/3W5H1V	- 5 Sections High	- 1 Void Row (1325w x 425h)	- 1325w x 400d x 2280h
CF/CB/3W5H2V	- 5 Sections High	- 2 Void Rows (1325w x 875h)	- 1325w x 400d x 2280h
CF/CB/3W5H3V	- 5 Sections High	- 3 Void Rows (1325w x 1325h)	- 1325w x 400d x 2280h

4 Sections Wide

CF/CB/4W3H1V	- 3 Sections High	- 1 Void Row (1775w x 425h)	- 1775w x 400d x 1380h
CF/CB/4W4H1V	- 4 Sections High	- 1 Void Row (1775w x 425h)	- 1775w x 400d x 1830h
CF/CB/4W4H2V	- 4 Sections High	- 2 Void Rows (1775w x 875h)	- 1775w x 400d x 1830h
CF/CB/4W5H1V	- 5 Sections High	- 1 Void Row (1775w x 425h)	- 1775w x 400d x 2280h
CF/CB/4W5H2V	- 5 Sections High	- 2 Void Rows (1775w x 875h)	- 1775w x 400d x 2280h
CF/CB/4W5H3V	- 5 Sections High	- 3 Void Rows (1775w x 1325h)	- 1775w x 400d x 2280h



Storage

Cubeform

MFC: Available in Ash, Autumn Cherry, Beech, Chester Oak, English Walnut, Grey, Grey Nebraska Oak, Laurentii Wenge, Natural Nebraska Oak and White
Coloured MFC: Available in Praline, Olive Green, Atlantic Blue, Sapphire Blue, Mustard Yellow, Terracotta and Conker Brown (2 Week Lead Time)
Nanotech: Available in Black (2 Week Lead Time)
Metalwork: Silver, Black Graphite and White - Add surcharge for Raw
Add surcharge for Praline, Olive Green, Atlantic Blue, Sapphire Blue, Mustard Yellow, Terracotta and Conker Brown (2 Week Lead Time)



CF/OFB

Cubeform Open Fronted Box

- Standard lead time. • 18mm top panel.
- Can be specified on standard shelves only (not corner shelves).
- Available with Standard, Whiteboard or Fabric back (page 241).

CF/OFB - Standard Back - 425w x 400d x 425h

CF/OFB/WB - Whiteboard Back - 425w x 400d x 425h

CF/OFB/FB - Fabric Back - 425w x 400d x 425h - Priced in Group 1

Fabric Groups: Group 1 - Add surcharge for Group 2-7



Storage

Cubeform

MFC: Available in Ash, Autumn Cherry, Beech, Chester Oak, English Walnut, Grey, Grey Nebraska Oak, Laurentii Wenge, Natural Nebraska Oak and White
Coloured MFC: Available in Praline, Olive Green, Atlantic Blue, Sapphire Blue, Mustard Yellow, Terracotta and Conker Brown (2 Week Lead Time)
Nanotech: Available in Black (2 Week Lead Time)
Metalwork: Silver, Black Graphite and White - Add surcharge for Raw
Add surcharge for Praline, Olive Green, Atlantic Blue, Sapphire Blue, Mustard Yellow, Terracotta and Conker Brown (2 Week Lead Time)



CF/SDB

Cubeform Single Door Box

- Standard lead time. • 18mm top panel. • Can be specified on standard shelves only (not corner shelves).
- Available with Standard, Combination or Digital Keypad Lock (see below).
- Available with Standard, Whiteboard or Fabric back (page 241).

CF/SDB - Standard Back - 425w x 400d x 425h
CF/SDB/WB - Whiteboard Back - 425w x 400d x 425h
CF/SDB/FB - Fabric Back - 425w x 400d x 425h - Priced in Group 1

Fabric Groups: Group 1 - Add surcharge for Group 2-7

Additional: Standard Key Lock (No Suffix)
Add surcharge for Combination Lock (.../CL), Digital Keypad Lock (.../DKL), Public Access Lock (.../KL)



CF/DU1

Cubeform 1 Drawer Unit

- Standard lead time. • 18mm top panel. • Can be specified on standard shelves only (not corner shelves).
- Lockable, includes 2x keys. • Available with Standard, Whiteboard or Fabric back (page 241).
- Alternative handles available (page 222).

CF/DU1 - Standard Back - 425w x 400d x 425h
CF/DU1/WB - Whiteboard Back - 425w x 400d x 425h
CF/DU1/FB - Fabric Back - 425w x 400d x 425h - Priced in Group 1

Fabric Groups: Group 1 - Add surcharge for Group 2-7



CF/DU2

Cubeform 2 Drawer Unit

- Standard lead time. • 18mm top panel. • Can be specified on standard shelves only (not corner shelves).
- Lockable, includes 2x keys. • Available with Standard, Whiteboard or Fabric back (page 241).
- Alternative handles available (page 222).

CF/DU2 - Standard Back - 425w x 400d x 425h
CF/DU2/WB - Whiteboard Back - 425w x 400d x 425h
CF/DU2/FB - Fabric Back - 425w x 400d x 425h - Priced in Group 1

Fabric Groups: Group 1 - Add surcharge for Group 2-7

Storage

Cubeform

MFC:	Available in Ash, Autumn Cherry, Beech, Chester Oak, English Walnut, Grey, Grey Nebraska Oak, Laurentii Wenge, Natural Nebraska Oak and White
Coloured MFC:	Available in Praline, Olive Green, Atlantic Blue, Sapphire Blue, Mustard Yellow, Terracotta and Conker Brown (2 Week Lead Time)
Nanotech:	Available in Black (2 Week Lead Time)
Fabric:	Fully upholstered - See below for pricing groups



CF/SPB

Cubeform Single Planter Box and Plants

- 2 week lead time on Plants, standard lead time on Planter Boxes. • This unit is supplied without plants, plant tray or liner.
- 18mm top panel. • Planter boxes can be used on standard shelves only (not corner shelves).
- 389w x 364d x 152h internal dimensions. • This unit is supplied without plants, plant tray or liner.
- The units require a waterproof membrane liner to protect against moisture and water ingress.
- For coloured MFC finishes, see 'Coloured MFC' price and suffix .../CON.

CF/SPB - Single Planter Box with No Plants - 425w x 400d x 170h



CF/SPB/PLT1

CF/SPB/PLT1 - Plants Only



CF/DPB

Cubeform Double Planter Box and Plants

- 2 week lead time on Plants, standard lead time on Planter Boxes. • This unit is supplied without plants, plant tray or liner.
- 18mm top panel. • Planter boxes can be used on standard shelves only (not corner shelves).
- 864w x 314d x 152h internal dimensions. • This unit is supplied without plants, plant tray or liner.
- The units require a waterproof membrane liner to protect against moisture and water ingress.
- For coloured MFC finishes, see 'Coloured MFC' price and suffix .../CON.

CF/DPB - Double Planter Box with No Plants - 900w x 350d x 170h



CF/DPB/PLT1

CF/DPB/PLT1 - Plants Only



CF/MS

Cubeform Stool

- Standard lead time. • Modular seating system. • Fully upholstered. • Hardwood frame.
- Fire retardant CMHR foam. • Protective feet.

CF/MS - 395w x 395d x 410h

Fabric Groups: Group 1 - Add surcharge for Group 2-7

Storage

Cubeform

MFC: Available in Ash, Autumn Cherry, Beech, Chester Oak, English Walnut, Grey, Grey Nebraska Oak, Laurentii Wenge, Natural Nebraska Oak and White
Coloured MFC: Available in Praline, Olive Green, Atlantic Blue, Sapphire Blue, Mustard Yellow, Terracotta and Conker Brown (3 Week Lead Time)
Nanotech: Available in Black (2 Week Lead Time)



CF/STV4



CF/STV4

Cubeform Single Sided TV Storage Unit

- This unit is compatible with standard shelves only.
- Standard lead time. • 100mm void at the rear for cable access and concealment.
- One piece back panel, allowing bespoke drilling for cable access. • TV not included.

CF/STV4 - 4 Sections Wide and 2 Sections High - 1775w x 400d x 875h

CF/STV3 - 3 Sections Wide and 2 Sections High - 1325w x 400d x 875h

CF/STV2 - 2 Sections Wide and 2 Sections High - 875w x 400d x 875h



CF/DTV4



CF/DTV4

Cubeform Double Sided TV Storage Unit

- This unit is compatible with standard shelves only.
- Standard lead time. • 100mm void in the centre for cable access and concealment.
- One piece back panel, allowing bespoke drilling for cable access. • TV not included.

CF/DTV4 - 4 Sections Wide and 2 Sections High - 1775w x 400d x 875h

CF/DTV3 - 3 Sections Wide and 2 Sections High - 1325w x 400d x 875h

CF/DTV2 - 2 Sections Wide and 2 Sections High - 875w x 400d x 875h

Storage

Cubeform Home Study Station

MFC:	Available in Ash, Autumn Cherry, Beech, Chester Oak, English Walnut, Grey, Grey Nebraska Oak, Laurentii Wenge, Natural Nebraska Oak and White
Coloured MFC:	Available in Praline, Olive Green, Atlantic Blue, Sapphire Blue, Mustard Yellow, Terracotta and Conker Brown (2 Week Lead Time)
Nanotech:	Available in Black (2 Week Lead Time)
Edging:	Add surcharge for Wenge, Black and Plywood Effect per top - Edging on 25mm White MFC and Black Nanotech only
Metalwork:	Silver, Black Graphite and White - Add surcharge for Raw Add surcharge for Praline, Olive Green, Atlantic Blue, Sapphire Blue, Mustard Yellow, Terracotta and Conker Brown (2 Week Lead Time)



CF/HSS15/6RH

Cubeform Home Study Station

- This item **must be securely fixed to a solid wall using the anti-tip device provided.**
- Standard lead time. • 25mm top panel. • Includes a wall fixing kit.
- Alternative handles available (page 222).

CF/HSS15/6... (LH or RH) - 1500w x 550d x 2070h



Storage

Cubeform Home Study Station

MFC:	Available in Ash, Autumn Cherry, Beech, Chester Oak, English Walnut, Grey, Grey Nebraska Oak, Laurentii Wenge, Natural Nebraska Oak and White
Coloured MFC:	Available in Praline, Olive Green, Atlantic Blue, Sapphire Blue, Mustard Yellow, Terracotta and Conker Brown (2 Week Lead Time)
Nanotech:	Available in Black (2 Week Lead Time)
Metalwork:	Silver, Black Graphite and White - Add surcharge for Raw Add surcharge for Praline, Olive Green, Atlantic Blue, Sapphire Blue, Mustard Yellow, Terracotta and Conker Brown (2 Week Lead Time)



CF/HSSOFB

Cubeform Home Study Station Open Fronted Box

- Standard lead time. • 18mm top panel.
- Can be specified on the Cubeform Home Study Stations overhead shelf only (not standard or corner shelves).

CF/HSSOFB - Standard Back - 1000w x 400d x 425h



CF/HSSDDB/NL

Cubeform Home Study Station Double Door Box

- Standard lead time. • 18mm top panel. • Can be specified on the Cubeform Home Study Stations overhead shelf only (not standard or corner shelves).
- Alternative handles available (page 222).

CF/HSSDDB/NL - Standard Back - 1000w x 400d x 425h



CF/HSSDPB

Cubeform Home Study Station Double Planter Box and Plants

- Standard lead time. • 18mm top panel. • 964w x 364d x 152h internal dimensions.
- Can be specified on the Cubeform Home Study Stations overhead shelf only (not standard or corner shelves).
- This unit is supplied without plants, plant tray or liner.
- The units require a waterproof membrane liner to protect against moisture and water ingress.

CF/HSSDPB - Double Planter Box with No Plants - 1000w x 400d x 170h



CF/HSSDPB/PLT1

CF/HSSDPB/PLT1 - Plants Only



CF/SDB/NLRH

Cubeform Home Study Station Single Door Box

- Standard lead time. • 18mm top panel.
- Can be specified on the Cubeform Home Study Stations overhead shelf only (not standard or corner shelves).
- Alternative handles available (page 222). • No lock version.

CF/SDB/NL... (LH or RH) - Standard Back - 425w x 400d x 425h

Storage

Cubeform Bench and Seats

MFC: Available in Ash, Autumn Cherry, Beech, Chester Oak, English Walnut, Grey, Grey Nebraska Oak, Laurentii Wenge, Natural Nebraska Oak and White
Nanotech: Available in Black (2 Week Lead Time)
Edging: Add surcharge for Wenge, Black and Plywood Effect per top - Edging on 25mm White MFC and Black Nanotech only
Metalwork: Silver, Black Graphite and White - Add surcharge for Chrome Effect and Raw
 Add surcharge for Praline, Olive Green, Atlantic Blue, Sapphire Blue, Mustard Yellow, Terracotta and Conker Brown (2 Week Lead Time)
Fabric: Fully upholstered seat pads - See individual items for pricing groups



CF/RB16/8

Cubeform Rectangular Bench

- Standard lead times.
- 25mm top panel.
- Central support rail.

CF/RB16/8 - 1600w x 800d x 740h
CF/RB14/8 - 1400w x 800d x 740h
CF/RB12/8 - 1200w x 800d x 740h

CF/RB16/6 - 1600w x 600d x 740h
CF/RB14/6 - 1400w x 600d x 740h
CF/RB12/6 - 1200w x 600d x 740h



CF/RSS8

Cubeform Rectangular Single Seat

- Standard lead times.
- Complete with wooden seat or fully upholstered seat pad.
- Wooden seat with 25mm top panel.
- Seat pad priced in Group 1.

Cubeform Rectangular Single Wooden Seat

CF/RSS8 - 800w x 350d x 465h - Wooden Seat
CF/RSS5 - 475w x 350d x 465h - Wooden Seat

Cubeform Rectangular Single Fabric Seat

CF/RSS8/F - 800w x 350d x 530h - Seat Pad

Fabric Groups: Group 1 - Add surcharge for Group 2-7



CF/RSS8/F

CF/RSS5/F - 475w x 350d x 530h - Seat Pad

Fabric Groups: Group 1 - Add surcharge for Group 2-7



CF/RDS14

Cubeform Rectangular Bench Seat

- Standard lead times.
- Complete with wooden seat or fully upholstered seat pad.
- Wooden seat with 25mm top panel.
- Seat pad priced in Group 1.

Cubeform Rectangular Bench Wooden Seat

CF/RDS14 - 1400w x 350d x 465h - Wooden Seat
CF/RDS12 - 1200w x 350d x 465h - Wooden Seat
CF/RDS10 - 1000w x 350d x 465h - Wooden Seat

Cubeform Rectangular Bench Fabric Seat

CF/RDS14/F - 1400w x 350d x 530h - Seat Pad

Fabric Groups: Group 1 - Add surcharge for Group 2-7



CF/RDS14/F

CF/RDS12/F - 1200w x 350d x 530h - Seat Pad

Fabric Groups: Group 1 - Add surcharge for Group 2-7

CF/RDS10/F - 1000w x 350d x 530h - Seat Pad

Fabric Groups: Group 1 - Add surcharge for Group 2-7

Storage

Cubeform Coffee Tables

MFC: Available in Ash, Autumn Cherry, Beech, Chester Oak, English Walnut, Grey, Grey Nebraska Oak, Laurentii Wenge, Natural Nebraska Oak and White
Nanotech: Available in Black (2 Week Lead Time)
Veneer: Available in Oak and Walnut (3 Week Lead Time)
Edging: Add surcharge for Wenge, Black and Plywood Effect per top - Edging on 25mm White MFC and Black Nanotech only
Metalwork: Silver, Black Graphite and White - Add surcharge for Raw
Add surcharge for Praline, Olive Green, Atlantic Blue, Sapphire Blue, Mustard Yellow, Terracotta and Conker Brown (2 Week Lead Time)



CF/RCT1



Rectangular Top

Cubeform Rectangular Coffee Table

- Standard lead times. • 25mm top panel.

CF/RCT1 - 900w x 475d x 400h



CF/SCT2



Square Top

Cubeform Square Coffee Table

- Standard lead times. • 25mm top panel.

CF/SCT1 - 475w x 475d x 400h

CF/SCT2 - 900w x 900d x 400h



CF/RCT1/BP



Rectangular Top

Cubeform Rectangular Coffee Table with Base Panel

- Standard lead times. • 25mm top panel and 18mm base panel.

CF/RCT1/BP - 900w x 475d x 400h



CF/SCT2/BP



Square Top

Cubeform Square Coffee Table with Base Panel

- Standard lead times. • 25mm top panel and 18mm base panel.

CF/SCT1/BP - 475w x 475d x 400h

CF/SCT2/BP - 900w x 900d x 400h



Storage

Recycling Units

MFC: Available in Ash, Autumn Cherry, Beech, Chester Oak, English Walnut, Grey, Grey Nebraska Oak, Laurentii Wenge, Natural Nebraska Oak and White
Edging: Add surcharge for Wenge, Black and Plywood Effect per top - *Edging on 25mm White MFC only*



RU8/5/10

Recycling Unit with 2 Sections

- Standard lead time. • 25mm top panel. • 2x hinged doors.
- Complete with 2x cardboard recycling boxes and 6x adhesive recycling stickers.
- Lockable, includes 2x keys. • Alternative handles available (page 222).

RU8/5/10 - 1x Adjustable Shelf - 800w x 500d x 1000h
RU8/4/10 - 1x Adjustable Shelf - 800w x 400d x 1000h

RU8/5/7 - No Adjustable Shelves - 800w x 500d x 740h
RU8/4/7 - No Adjustable Shelves - 800w x 400d x 740h



RU10/5/10

Recycling Unit with 3 Sections

- Standard lead time. • 25mm top panel. • 2x hinged doors.
- Complete with 3x cardboard recycling boxes and 6x adhesive recycling stickers.
- Lockable, includes 2x keys. • Alternative handles available (page 222).

RU10/5/10 - 1x Adjustable Shelf - 990w x 500d x 1000h
RU10/4/10 - 1x Adjustable Shelf - 990w x 400d x 1000h

RU10/5/7 - No Adjustable Shelves - 990w x 500d x 740h
RU10/4/7 - No Adjustable Shelves - 990w x 400d x 740h



RU13/5/10

Recycling Unit with 4 Sections

- Standard lead time. • 25mm top panel. • 2x hinged doors.
- Complete with 4x cardboard recycling boxes and 6x adhesive recycling stickers.
- Lockable, includes 2x keys. • Alternative handles available (page 222).

RU13/5/10 - 1x Adjustable Shelf - 1300w x 500d x 1000h
RU13/4/10 - 1x Adjustable Shelf - 1300w x 400d x 1000h

RU13/5/7 - No Adjustable Shelves - 1300w x 500d x 740h
RU13/4/7 - No Adjustable Shelves - 1300w x 400d x 740h



6x Adhesive Stickers

Adhesive Stickers

- Standard lead time. • 6x adhesive stickers available with recycling units (see above).



RUB

Replacement Recycling Boxes

- Standard lead time. • Cardboard recycling boxes compatible with recycling units (see above).

RUB - 300w x 300d x 600h

Storage

Modular Lockers



Storage

Modular Lockers

How to Specify Modular Lockers

Choose any amount of modular lockers required for the given job using the code combinations below.

A - 1x 1050h Door

1x 1050h door with individual compartment and coat rail

B - 3x 350h Doors

3x 350h doors with individual compartments

C - 1x 350h Door and 1x 700h Door

1x 350h door with an individual compartment - 1x 700h door with 2x compartments

D - 1x 350h Door and 1x 700h Door

1x 700h door with 2x compartments - 1x 350h door with an individual compartment

E - 1x 1400h Door

1x 1400h door with 2x compartments and coat rail

F - 4x 350h Doors

4x 350h doors with individual compartments

G - 2x 700h Door

2x 700h doors with 2x compartments each

H - 2x 350h Doors and 1x 700h Door

2x 350h doors with individual compartments - 1x 700h door with 2x compartments

J - 2x 350h Doors and 1x 700h Door

1x 350h door with an individual compartment - 1x 700h door with 2x compartments
- 1x 350h door with an individual compartment

K - 2x 350h Doors and 1x 700h Door

1x 700h door with 2x compartments - 2x 350h doors with individual compartments

L - 1x 350h Door and 1x 1050h Door

1x 350h door with an individual compartment - 1x 1050h door with coat rail

M - 1x 1050h Door and 1x 350h Door

1x 1050h door with coat rail - 1x 350h door with an individual compartment

N - 5x 350h Doors

5x 350h doors with individual compartments

There are 4 locking styles to choose from, these are Standard Lock, Combination Lock, Digital Keypad Lock and Public Access Lock. Suffix the relevant code onto the end of the unit code (e.g. for use of the Digital Keypad Lock on the **NML/3B**, use code **NML/3B/DKL**). An additional cost per unit will need to be added to the order. See individual pages for details.

Additionally, an Integrated Postal Slot can be specified using suffix **.../PST**. A Modular Locker Specification Form will need to be supplied with your order which will detail which doors require a postal slot. An additional cost per door will need to be added to the order. See page 262 for details.

For contrasting finishes on any or all the doors so it is different to the carcass, suffix **.../CON**. A Modular Locker Specification Form will need to be supplied with your order which will detail what finishes you require and where. If you decide to use one of the coloured MFC or Nanotech finishes, only available on door fronts, this can also be detailed on the Modular Locker Specification Form. An additional cost per door will need to be added to the order. See page 262 for details.

Once chosen, specify the length of the modular lockers top / bottom by suffixing the amount of modular lockers used onto the end of its code (e.g. when 3x modular lockers are specified, use code **NML/TB3**). See page 262 for details.

Important Information: Combination locks are designed to be operated without the use of a key. The key supplied with each locker is unique to the individual lock, identifiable by the serial number on both the key and on the internal lock. We recommend these are kept in a secure location and used for recovering the locking codes **ONLY** and not for general unlocking / locking.

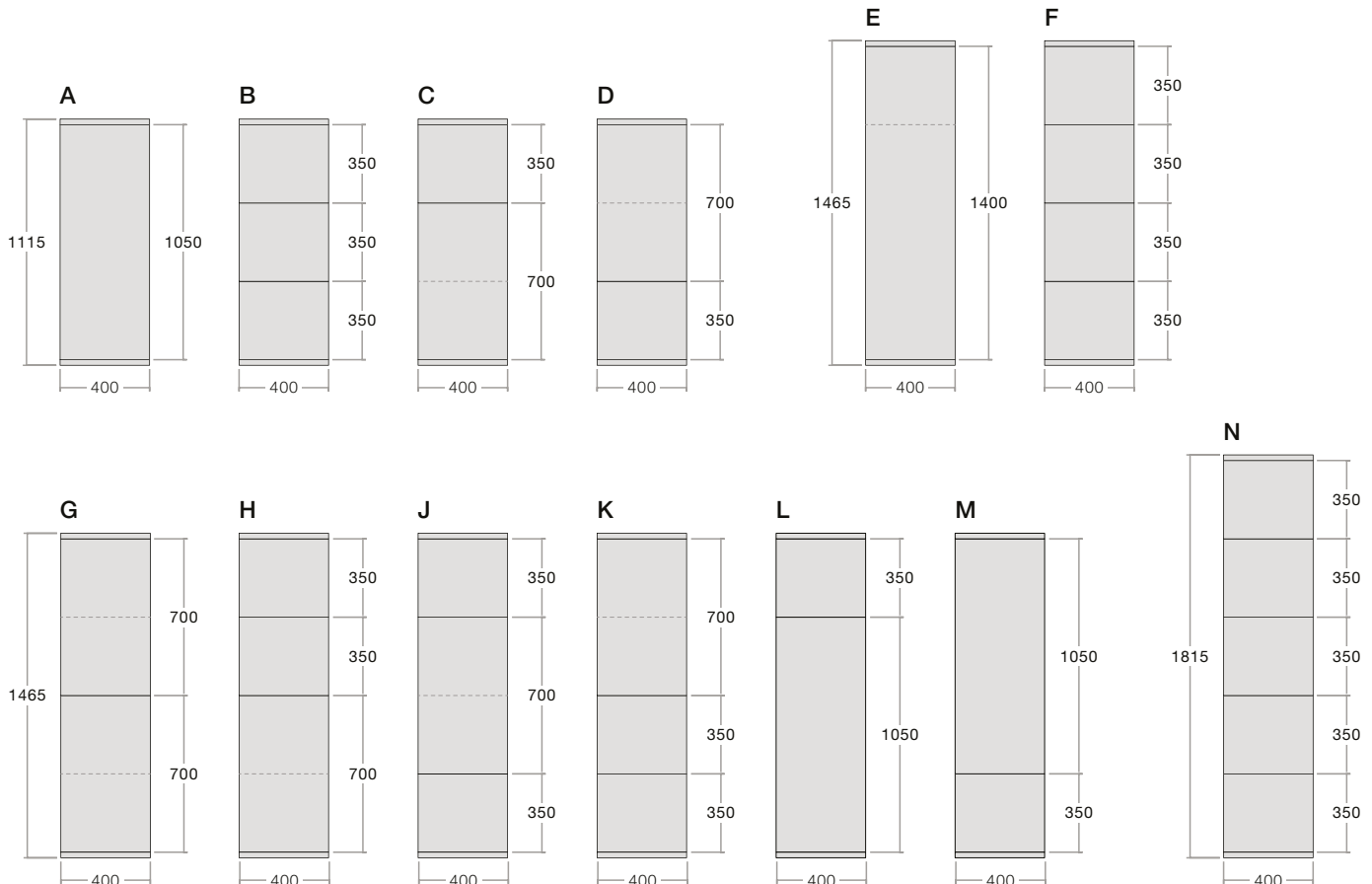

Storage

Modular Lockers

MFC:	Available in Ash, Autumn Cherry, Beech, Chester Oak, English Walnut, Grey, Grey Nebraska Oak, Laurentii Wenge, Natural Nebraska Oak and White
Coloured MFC:	Available in Praline, Olive Green, Atlantic Blue, Sapphire Blue, Mustard Yellow, Terracotta and Conker Brown (2 Week Lead Time)
Nanotech:	Available in Black (2 Week Lead Time)
Edging:	Add surcharge for Wenge, Black and Plywood Effect per top - Edging on 25mm White MFC and Black Nanotech only



NML/3A

Modular Locker Unit with Single Door

- **Modular locker top / bottom required with this product (page 260).**
- Standard lead time. • 18mm top panel. • 1115h is including Modular Locker Top and Bottom.
- 1x lockable door with a clothing compartment and coat rail.
- Clothing internal compartment size is 360w x 462d x 1025h.

NML/3A - 1x 1050h Door - 400w x 500d x 1115h

Additional: Standard Key Lock (No Suffix)
Add surcharge for Combination Lock (.../CL), Digital Keypad Lock (.../DKL), Public Access Lock (.../KL)

Additional: Add surcharge per door for Postal Slots (.../PST)
Standard MFC Contrasting Door Finish (.../CON)
Add surcharge per door for Coloured MFC Contrasting Door Finish (.../CON)
Add surcharge per door for Nanotech Contrasting Door Finish (.../CON)
Further information required, contact Customer Services for specification form (page 262)



NML/3B

Modular Locker Unit with 3x Individual Doors

- **Modular locker top / bottom required with this product (page 260).**
- Standard lead time. • 18mm top panel. • 1115h is including Modular Locker Top and Bottom.
- 3x lockable doors with individual compartments.
- Individual internal compartment sizes are 360w x 462d x 325h (min).

NML/3B - 3x 350h Doors - 400w x 500d x 1115h

Additional: Standard Key Lock (No Suffix)
Add surcharge for Combination Lock (.../CL), Digital Keypad Lock (.../DKL), Public Access Lock (.../KL)

Additional: Add surcharge per door for Postal Slots (.../PST)
Standard MFC Contrasting Door Finish (.../CON)
Add surcharge per door for Coloured MFC Contrasting Door Finish (.../CON)
Add surcharge per door for Nanotech Contrasting Door Finish (.../CON)
Further information required, contact Customer Services for specification form (page 262)



NML/3C

Modular Locker Unit with 2x Individual Doors

- **Modular locker top / bottom required with this product (page 260).**
- Standard lead time. • 18mm top panel. • 1115h is including Modular Locker Top and Bottom.
- 1x lockable door with an individual compartment. • 1x lockable door with 2x compartments.
- Individual internal compartment sizes are 360w x 462d x 325h (min).

NML/3C - 1x 350h Door (Top) and 1x 700h Door (Bottom) - 400w x 500d x 1115h

NML/3D - 1x 700h Door (Top) and 1x 350h Door (Bottom) - 400w x 500d x 1115h

Additional: Standard Key Lock (No Suffix)
Add surcharge for Combination Lock (.../CL), Digital Keypad Lock (.../DKL), Public Access Lock (.../KL)

Additional: Add surcharge per door for Postal Slots (.../PST)
Standard MFC Contrasting Door Finish (.../CON)
Add surcharge per door for Coloured MFC Contrasting Door Finish (.../CON)
Add surcharge per door for Nanotech Contrasting Door Finish (.../CON)
Further information required, contact Customer Services for specification form (page 262)



NML/3D

Storage

Modular Lockers

MFC:	Available in Ash, Autumn Cherry, Beech, Chester Oak, English Walnut, Grey, Grey Nebraska Oak, Laurentii Wenge, Natural Nebraska Oak and White
Coloured MFC:	Available in Praline, Olive Green, Atlantic Blue, Sapphire Blue, Mustard Yellow, Terracotta and Conker Brown (2 Week Lead Time)
Nanotech:	Available in Black (2 Week Lead Time)
Edging:	Add surcharge for Wenge, Black and Plywood Effect per top - Edging on 25mm White MFC and Black Nanotech only



NML/4E

Modular Locker Unit with Single Door

- **Modular locker top / bottom required with this product (page 260).**
- Standard lead time. • 18mm top panel. • 1465h is including Modular Locker Top and Bottom.
- 1x lockable door with an individual compartment and 1x clothing compartment and coat rail.
- Individual internal compartment size is 360w x 462d x 325h.
- Clothing internal compartment size is 360w x 462d x 1017h.

NML/4E - 1x 1400h Door - 400w x 500d x 1465h

Additional: Standard Key Lock (No Suffix)
Add surcharge for Combination Lock (.../CL), Digital Keypad Lock (.../DKL), Public Access Lock (.../KL)

Additional: Add surcharge per door for Postal Slots (.../PST)
Standard MFC Contrasting Door Finish (.../CON)
Add surcharge per door for Coloured MFC Contrasting Door Finish (.../CON)
Add surcharge per door for Nanotech Contrasting Door Finish (.../CON)
Further information required, contact Customer Services for specification form (page 262)



NML/4F

Modular Locker Unit with 4x Individual Doors

- **Modular locker top / bottom required with this product (page 260).**
- Standard lead time. • 18mm top panel. • 1465h is including Modular Locker Top and Bottom.
- 4x lockable doors with individual compartments.
- Individual internal compartment sizes are 360w x 462d x 325h (min).

NML/4F - 4x 350h Doors - 400w x 500d x 1465h

Additional: Standard Key Lock (No Suffix)
Add surcharge for Combination Lock (.../CL), Digital Keypad Lock (.../DKL), Public Access Lock (.../KL)

Additional: Add surcharge per door for Postal Slots (.../PST)
Standard MFC Contrasting Door Finish (.../CON)
Add surcharge per door for Coloured MFC Contrasting Door Finish (.../CON)
Add surcharge per door for Nanotech Contrasting Door Finish (.../CON)
Further information required, contact Customer Services for specification form (page 262)



NML/4G

Modular Locker Unit with 2x Individual Doors

- **Modular locker top / bottom required with this product (page 260).**
- Standard lead time. • 18mm top panel. • 1465h is including Modular Locker Top and Bottom.
- 2x lockable doors with 2x compartments each.
- Individual internal compartment sizes are 360w x 462d x 325h (min).

NML/4G - 2x 700h Doors - 400w x 500d x 1465h

Additional: Standard Key Lock (No Suffix)
Add surcharge for Combination Lock (.../CL), Digital Keypad Lock (.../DKL), Public Access Lock (.../KL)

Additional: Add surcharge per door for Postal Slots (.../PST)
Standard MFC Contrasting Door Finish (.../CON)
Add surcharge per door for Coloured MFC Contrasting Door Finish (.../CON)
Add surcharge per door for Nanotech Contrasting Door Finish (.../CON)
Further information required, contact Customer Services for specification form (page 262)

Storage

Modular Lockers

MFC: Available in Ash, Autumn Cherry, Beech, Chester Oak, English Walnut, Grey, Grey Nebraska Oak, Laurentii Wenge, Natural Nebraska Oak and White
Coloured MFC: Available in Praline, Olive Green, Atlantic Blue, Sapphire Blue, Mustard Yellow, Terracotta and Conker Brown (2 Week Lead Time)
Nanotech: Available in Black (2 Week Lead Time)
Edging: Add surcharge for Wenge, Black and Plywood Effect per top - Edging on 25mm White MFC and Black Nanotech only



NML/4H



NML/4J



NML/4K

Modular Locker Unit with 3x Individual Doors

- **Modular locker top / bottom required with this product (page 260).**
- Standard lead time. • 18mm top panel. • 1465h is including Modular Locker Top and Bottom.
- 2x lockable doors with individual compartments. • 1x lockable door with 2x compartments.
- Individual internal compartment sizes are 360w x 462d x 325h (min).

NML/4H - 2x 350h Doors (Top) and 1x 700h Door (Bottom) - 400w x 500d x 1465h
NML/4J - 2x 350h Doors (Top and Bottom) and 1x 700h Door (Middle) - 400w x 500d x 1465h
NML/4K - 1x 700h Door (Top) and 2x 350h Doors (Bottom) - 400w x 500d x 1465h

Additional: Standard Key Lock (No Suffix)
 Add surcharge for Combination Lock (.../CL), Digital Keypad Lock (.../DKL), Public Access Lock (.../KL)

Additional: Add surcharge per door for Postal Slots (.../PST)
 Standard MFC Contrasting Door Finish (.../CON)
 Add surcharge per door for Coloured MFC Contrasting Door Finish (.../CON)
 Add surcharge per door for Nanotech Contrasting Door Finish (.../CON)
 Further information required, contact Customer Services for specification form (page 262)



NML/4L



NML/4M

Modular Locker Unit with 2x Individual Doors

- **Modular locker top / bottom required with this product (page 260).**
- Standard lead time. • 18mm top panel. • 1465h is including Modular Locker Top and Bottom.
- 1x lockable door with an individual compartment. • 1x lockable door with a clothing compartment and coat rail.
- Individual internal compartment sizes are 360w x 462d x 325h (min).
- Clothing internal compartment size is 360w x 462d x 1025h.

NML/4L - 1x 350h Door (Top) and 1x 1050h Door (Bottom) - 400w x 500d x 1465h
NML/4M - 1x 1050h Door (Top) and 1x 350h Door (Bottom) - 400w x 500d x 1465h

Additional: Standard Key Lock (No Suffix)
 Add surcharge for Combination Lock (.../CL), Digital Keypad Lock (.../DKL), Public Access Lock (.../KL)

Additional: Add surcharge per door for Postal Slots (.../PST)
 Standard MFC Contrasting Door Finish (.../CON)
 Add surcharge per door for Coloured MFC Contrasting Door Finish (.../CON)
 Add surcharge per door for Nanotech Contrasting Door Finish (.../CON)
 Further information required, contact Customer Services for specification form (page 262)

Storage

Modular Lockers

MFC: Available in Ash, Autumn Cherry, Beech, Chester Oak, English Walnut, Grey, Grey Nebraska Oak, Laurentii Wenge, Natural Nebraska Oak and White
Coloured MFC: Available in Praline, Olive Green, Atlantic Blue, Sapphire Blue, Mustard Yellow, Terracotta and Conker Brown (2 Week Lead Time)
Nanotech: Available in Black (2 Week Lead Time)
Edging: Add surcharge for Wenge, Black and Plywood Effect per top - Edging on 25mm White MFC and Black Nanotech only



NML/5N

Modular Locker Unit with 5x Individual Doors

- **Modular locker top / bottom required with this product (page 260).**
- Standard lead time. • 18mm top panel. • 1815h is including Modular Locker Top and Bottom.
- 5x lockable doors with individual compartments.
- Individual internal compartment sizes are 360w x 462d x 325h (min).

NML/5N - 5x 350h Doors - 400w x 500d x 1815h

Additional: Standard Key Lock (No Suffix)
 Add surcharge for Combination Lock (.../CL), Digital Keypad Lock (.../DKL), Public Access Lock (.../KL)

Additional: Add surcharge per door for Postal Slots (.../PST)
 Standard MFC Contrasting Door Finish (.../CON)
 Add surcharge per door for Coloured MFC Contrasting Door Finish (.../CON)
 Add surcharge per door for Nanotech Contrasting Door Finish (.../CON)
 Further information required, contact Customer Services for specification form (page 262)



Locking Styles



Standard Key Lock
 Operated using a typical insert, turn and open design.



Combination Lock
 Operated using a 4 digit encryption. Once the lock has been programmed with the personal 4 digit code, further access can be achieved without the key (1x supplied).



Digital Keypad Lock
 Keyless locking solution, programmed using a battery operated digital keypad where users assign the security code to access the locker.



Public Access Lock
 Lockable with the use of an innovative digital lock that can be programmed with a 'Public Access' function. This forces the system to auto-unlock after a pre-set time frame (between 1 and 24 hours), eliminating the hassle of lost keys or abandoned belongings.

Storage

Modular Lockers

MFC: Available in Ash, Autumn Cherry, Beech, Chester Oak, English Walnut, Grey, Grey Nebraska Oak, Laurentii Wenge, Natural Nebraska Oak and White
Coloured MFC: Available in Praline, Olive Green, Atlantic Blue, Sapphire Blue, Mustard Yellow, Terracotta and Conker Brown (2 Week Lead Time)
Nanotech: Available in Black (2 Week Lead Time)
Edging: Add surcharge for Wenge, Black and Plywood Effect per top - Edging on 25mm White MFC and Black Nanotech only



NML/4F/CON

Contrasting Door Finish

• Standard lead time. • 18mm top panel. • To apply a contrasting door to the carcass, suffix **.../CON** to your chosen unit and submit a Modular Locker Specification Form.

.../CON - Standard MFCs - Contrasting Door to the Carcass - Price per Door

.../CON - Coloured MFCs - Contrasting Door to the Carcass - Price per Door

.../CON - Nanotech - Contrasting Door to the Carcass - Price per Door



NML/4F/PST

Modular Locker Postal Slot

• Standard lead time. • To apply a postal slot to any door, suffix **.../PST** to your chosen unit and submit a Modular Locker Specification Form. • Postal Slots are 25h.

.../PST - Postal Slot in a Door - Price per Door



NML/TB4
Illustrated in red

Modular Locker Top and Bottom

• Standard lead time. • 25mm top panel. • Specify the modular locker top and bottom dependent of how many modular lockers you are using in a singular run.
• Both top and bottom single piece panels supplied. • Contrasting edging available on top panel only.

NML/TB1 - For 1x Modular Locker - 400w x 500d

NML/TB2 - For 2x Modular Lockers - 800w x 500d

NML/TB3 - For 3x Modular Lockers - 1200w x 500d

NML/TB4 - For 4x Modular Lockers - 1600w x 500d

NML/TB5 - For 5x Modular Lockers - 2000w x 500d

NML/TB6 - For 6x Modular Lockers - 2400w x 500d



Storage

HotBox



EHB2RN

Hotbox 2 Unit

- Standard lead time. • Main body in white with 2x utility pots. • Includes tablet strap.
- Fabric bib, fabric pen holder and accessories not included.

HB2/UW - 426w x 125d x 311h



EHB2B5

Hotbox 2 Fabric Bib

- £63 surcharge on orders below 10 units.
- Standard lead time. • Individual fabric bibs to fix onto HB2/UW. • Hotbox 2 Unit not included.

HB2/B/BC - Camira Quest: Barnacle

HB2/B/LP - Camira Quest: Limpet

HB2/B/PB - Camira Quest: Pebble

HB2/B/SG - Camira Quest: Sea Grass

HB2/B/BX - Camira Main Line Flax: Brixton

HB2/B/EP - Camira Main Line Flax: Epping

HB2/B/GW - Camira Main Line Flax: Greenwich

HB2/B/SF - Camira Main Line Flax: Stratford



EHB2R/B2

HotBox 2 Unit with Fabric Bib

- £63 surcharge on orders below 10 units. • Standard lead time.
- Main body in white with 2x utility pots and fabric bib. • Fabric pen holder and accessories not included.

HB2/UW/BC - Camira Quest: Barnacle

HB2/UW/LP - Camira Quest: Limpet

HB2/UW/PB - Camira Quest: Pebble

HB2/UW/SG - Camira Quest: Sea Grass

HB2/UW/BX - Camira Main Line Flax: Brixton

HB2/UW/EP - Camira Main Line Flax: Epping

HB2/UW/GW - Camira Main Line Flax: Greenwich

HB2/UW/SF - Camira Main Line Flax: Stratford



EHB2ST/G

Hotbox 2 Shoulder Strap

- Standard lead time. • Fixes onto the Hotbox 2 Unit and allows the unit to be carried with ease.

HB2/SG - Grey

HB2/SB - Black

HotBox 2 Fabric Finishes

- The 8 finishes below are available on the HotBox 2 Units above.



Camira Quest:
Barnacle



Camira Quest:
Limpet



Camira Quest:
Pebble



Camira Quest:
Sea Grass



Camira Main Line
Flax: Brixton



Camira Main Line
Flax: Epping



Camira Main Line
Flax: Greenwich



Camira Main Line
Flax: Stratford

Whilst every effort has been made to ensure accurate colours are illustrated in this document, there may be a slight colour difference due to the printing process, therefore please refer to our colour sample swatches prior to ordering.

Desk Mounted Screens

System, Acoustic and Contract



Desk mounted screens act as a division between multiple users, adding a degree of privacy if required. The portfolio provides compatible desk mounted screens in several styles, for all desking ranges manufactured by Elite Office Furniture. The options include frameless and aluminium trim panels, manufactured from acrylic, MFC, or with an upholstered finish. A range of acoustic screens certified to Class B International Standards, ISO 354:2003, ISO11654:1997, ISO9613 & ISO9613-1:1993, are available for over desk applications.



Screens

Desk Mounted Screens for Specific Ranges

Progress Plus Desk Mounted Screens

- System Screen with Optional Management Rail.
- Acoustic Screen.
- Contract Screen.
- Blade Screen Panel.
- See page 22-24.



PPSS16F

Progress Desk Mounted Screens

- System Screen with Optional Management Rail.
- Acoustic Screen.
- Blade Screen Panel.
- See page 31-33.



PSS16F

Progress Lite Desk Mounted Screens

- System Screen with Optional Management Rail.
- Acoustic Screen.
- See page 36.



PLSS16F

Linnea Elevate Desk Mounted Screens

- System Screen with Optional Management Rail.
- Acoustic Screen.
- See page 40-41.



LESS16F

Lux Desk Mounted Screens

- Acoustic Screen.
- See page 51.



AELUXSS1150F

Linnea Desk Mounted Screens

- System Screen with Optional Management Rail.
- Acoustic Screen.
- Contract Screen.
- Flexible Return Contract Screen.
- Flexible Return Glazed Screen.
- See page 67-71.



ELSS16F

Matrix Plus Desk Mounted Screens

- System Screen with Optional Management Rail.
- Acoustic Screen.
- Flexible Return Contract Screen.
- Contract Screen.
- See page 81-84.



ELSS16F

Call Centre Desk Mounted Screens

- System Screen.
- Acoustic Screen.
- Contract Screen.
- See page 126.



ECCSSC/F

Alto, Harmony and Loco Desk Mounted Screens

- Flexible Return Contract Screen.
- See page 180.



ECSFR6F/D

Hygiene Protection Screens

- Desk Mounted.
- Screen Mounted.
- Free Standing.
- Floor Standing.
- See Elites HPS Price Guide.



ELHPS16

Screens

Desk Mounted System Screens

Fabric:	Fully upholstered with pinnable surface - See below for pricing groups
Acrylic:	Available in Blue, Green, Orange, Red, Frosted and Clear
MFC:	Available in Ash, Autumn Cherry, Beech, Chester Oak, English Walnut, Grey, Grey Nebraska Oak, Laurentii Wenge, Natural Nebraska Oak and White
Metalwork:	Anodised Silver, Black Graphite and White
Fabric Groups:	Group 1 - Add surcharge for Group 2-7



ESS16F

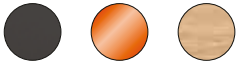

Fabric, Acrylic and MFC Finishes

Elite Desk Mounted System Screen for Single Workstations

- Standard lead time.
- Straight dividing screens with aluminium trim and optional management rail.
- Screen is bracketed to the outer edge of the desk top.
- Available as Hygiene Protection Screens and add-ons (see HPS Guide).
- Optional screen mounted accessories available (page 293).

Straight System Screen

ESS20...	- 1973w x 27d x 375h
ESS18...	- 1773w x 27d x 375h
ESS16...	- 1573w x 27d x 375h
ESS15...	- 1473w x 27d x 375h
ESS14...	- 1373w x 27d x 375h
ESS12...	- 1173w x 27d x 375h
ESS10...	- 973w x 27d x 375h
ESS8...	- 773w x 27d x 375h

Straight System Screen with Management Rail

ESS20M...	- 1973w x 27d x 375h
ESS18M...	- 1773w x 27d x 375h
ESS16M...	- 1573w x 27d x 375h
ESS15M...	- 1473w x 27d x 375h
ESS14M...	- 1373w x 27d x 375h
ESS12M...	- 1173w x 27d x 375h
ESS10M...	- 973w x 27d x 375h
ESS8M...	- 773w x 27d x 375h

Finishes:	Fabric System Screens with or without Management Rail (suffix ...F) Acrylic System Screens with or without Management Rail (suffix ...A) MFC System Screens without Management Rail (suffix ...MFC) MFC System Screens with Management Rail (suffix .../MFC)
Compatibility:	For use without Power Modules and Monitor Arms with brackets (no suffix) For use with Power Modules and Monitor Arms with brackets (creates a minimum 12mm void) (suffix .../V)
Additional:	Optional 4 way link post (ELP375)



ESSC16F



Fabric and MFC Finishes

Elite Desk Mounted System Screen for Single Workstations

- Standard lead time.
- Curved or wave dividing screens with aluminium trim.
- Screen is bracketed to the outer edge of the desk top.

Curved System Screen

ESSC20	- 1973w x 27d x 375h
ESSC18	- 1773w x 27d x 375h
ESSC16	- 1573w x 27d x 375h
ESSC14	- 1373w x 27d x 375h
ESSC12	- 1173w x 27d x 375h
ESSC10	- 973w x 27d x 375h
ESSC8	- 773w x 27d x 375h

Wave System Screen

ESSW20	- 1973w x 27d x 375h
ESSW18	- 1773w x 27d x 375h
ESSW16	- 1573w x 27d x 375h
ESSW14	- 1373w x 27d x 375h
ESSW12	- 1173w x 27d x 375h
ESSW10	- 973w x 27d x 375h
ESSW8	- 773w x 27d x 375h

Finishes:	Fabric System Screens (suffix ...F) MFC System Screens (suffix ...MFC)
Compatibility:	For use without Power Modules and Monitor Arms with brackets (no suffix) For use with Power Modules and Monitor Arms with brackets (creates a minimum 12mm void) (suffix .../V)
Additional:	Optional 4 way link post (ELP375)

Screens

Desk Mounted System Screens

Fabric:	Fully upholstered with pinnable surface - See below for pricing groups
Acrylic:	Available in Blue, Green, Orange, Red, Frosted and Clear
MFC:	Available in Ash, Autumn Cherry, Beech, Chester Oak, English Walnut, Grey, Grey Nebraska Oak, Laurentii Wenge, Natural Nebraska Oak and White
Metalwork:	Anodised Silver, Black Graphite and White
Fabric Groups:	Group 1 - Add surcharge for Group 2-7



ESS120/12F

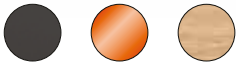

Fabric, Acrylic and MFC Finishes

Elite Desk Mounted System Screen for 120 Degree Workstations

- Standard lead time. • 3 way link post is required (ELP375/120).
- Straight dividing screens with aluminium trim and optional management rail.
- Screen is fixed to the link post at one end and is bracketed to the leg frame at the other end.
- Available as Hygiene Protection Screens and add-ons (see HPS Guide).
- Optional screen mounted accessories available (page 293).

Straight System Screen

ESS120/12... - 1179w x 27d x 375h

ESS120/10... - 979w x 27d x 375h

Straight System Screen with Management Rail

ESS120/12M... - 1179w x 27d x 375h

ESS120/10M... - 979w x 27d x 375h

Finishes: Fabric System Screens with or without Management Rail (suffix ...F)
Acrylic System Screens with or without Management Rail (suffix ...A)
MFC System Screens without Management Rail (suffix ...MFC)
MFC System Screens with Management Rail (suffix .../MFC)

Additional: 3 way link post is required (ELP375/120)



ESSC120/12F



Fabric and MFC Finishes

Elite Desk Mounted System Screen for 120 Degree Workstations

- Standard lead time. • 3 way link post is required (ELP375/120).
- Curved and wave dividing screens with aluminium trim.
- Screen is fixed to the link post at one end and is bracketed to the leg frame at the other end.

Curved System Screen

ESSC120/12... - 1179w x 27d x 375h

ESSC120/10... - 979w x 27d x 375h

Wave System Screen

ESSW120/12... - 1179w x 27d x 375h

ESSW120/10... - 979w x 27d x 375h

Finishes: Fabric System Screens (suffix ...F)
MFC System Screens (suffix ...MFC)

Additional: 3 way link post is required (ELP375/120)

Screens

Desk Mounted System Screens

Fabric:	Fully upholstered with pinnable surface - See below for pricing groups
Acrylic:	Available in Blue, Green, Orange, Red, Frosted and Clear
MFC:	Available in Ash, Autumn Cherry, Beech, Chester Oak, English Walnut, Grey, Grey Nebraska Oak, Laurentii Wenge, Natural Nebraska Oak and White
Metalwork:	Anodised Silver, Black Graphite and White
Fabric Groups:	Group 1 - Add surcharge for Group 2-7



ESSMR16F

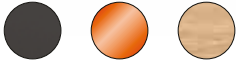

Fabric, Acrylic and MFC Finishes

Elite Desk Mounted Mid Return System Screen for Workstations Desks

- Standard lead time. • 4 way link post is required (ELP375).
- Straight dividing screens with aluminium trim and optional management rail.
- Screen is fixed to the link post at one end and uses a metal blade between the desk tops to fix its position.
- Available as Hygiene Protection Screens and add-ons (see HPS Guide).
- Optional screen mounted accessories available (page 293).

Straight System Screen

ESSMR18...	- 1773w x 27d x 375h
ESSMR16...	- 1573w x 27d x 375h
ESSMR14...	- 1373w x 27d x 375h
ESSMR12...	- 1173w x 27d x 375h
ESSMR10...	- 973w x 27d x 375h
ESSMR8...	- 773w x 27d x 375h
ESSMR6...	- 573w x 27d x 375h

Straight System Screen with Management Rail

ESSMR18M...	- 1773w x 27d x 375h
ESSMR16M...	- 1573w x 27d x 375h
ESSMR14M...	- 1373w x 27d x 375h
ESSMR12M...	- 1173w x 27d x 375h
ESSMR10M...	- 973w x 27d x 375h
ESSMR8M...	- 773w x 27d x 375h
ESSMR6M...	- 573w x 27d x 375h

Finishes: Fabric System Screens with or without Management Rail (suffix ...F)
Acrylic System Screens with or without Management Rail (suffix ...A)
MFC System Screens without Management Rail (suffix ...MFC)
MFC System Screens with Management Rail (suffix .../MFC)

Additional: 4 way link post is required (ELP375)



ESSMRC8F



Fabric and MFC Finishes

Elite Desk Mounted Mid Return System Screen for Workstations Desks

- Standard lead time. • 4 way link post is required (ELP375). • Curved or wave dividing screens with aluminium trim.
- Screen is fixed to the link post at one end and uses a metal blade between the desk tops to fix its position.

Curved System Screen

ESSMRC18...	- 1773w x 27d x 375h
ESSMRC16...	- 1573w x 27d x 375h
ESSMRC14...	- 1373w x 27d x 375h
ESSMRC12...	- 1173w x 27d x 375h
ESSMRC10...	- 973w x 27d x 375h
ESSMRC8...	- 773w x 27d x 375h

Wave System Screen

ESSMRW18...	- 1773w x 27d x 375h
ESSMRW16...	- 1573w x 27d x 375h
ESSMRW14...	- 1373w x 27d x 375h
ESSMRW12...	- 1173w x 27d x 375h
ESSMRW10...	- 973w x 27d x 375h
ESSMRW8...	- 773w x 27d x 375h

Finishes: Fabric System Screens (suffix ...F)
MFC System Screens (suffix ...MFC)

Additional: 4 way link post is required (ELP375)

Screens

Desk Mounted System Screens

Fabric:	Fully upholstered with pinnable surface - See below for pricing groups
Acrylic:	Available in Blue, Green, Orange, Red, Frosted and Clear
MFC:	Available in Ash, Autumn Cherry, Beech, Chester Oak, English Walnut, Grey, Grey Nebraska Oak, Laurentii Wenge, Natural Nebraska Oak and White
Metalwork:	Anodised Silver, Black Graphite and White
Fabric Groups:	Group 1 - Add surcharge for Group 2-7



ESSER16F

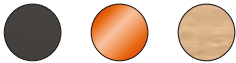

Fabric, Acrylic and MFC Finishes

Elite Desk Mounted End Return System Screen for Workstations Desks

- Standard lead time. • 4 way link post is required (ELP375).
- Straight dividing screens with aluminium trim and optional management rail.
- Screen is fixed to the link post at one end and is bracketed to the desk tops at the other.
- Available as Hygiene Protection Screens and add-ons (see HPS Guide).
- Optional screen mounted accessories available (page 293).

Straight System Screen

ESSER18...	- 1773w x 27d x 375h
ESSER16...	- 1573w x 27d x 375h
ESSER14...	- 1373w x 27d x 375h
ESSER12...	- 1173w x 27d x 375h
ESSER10...	- 973w x 27d x 375h
ESSER8...	- 773w x 27d x 375h
ESSER6...	- 573w x 27d x 375h

Straight System Screen with Management Rail

ESSER18M...	- 1773w x 27d x 375h
ESSER16M...	- 1573w x 27d x 375h
ESSER14M...	- 1373w x 27d x 375h
ESSER12M...	- 1173w x 27d x 375h
ESSER10M...	- 973w x 27d x 375h
ESSER8M...	- 773w x 27d x 375h
ESSER6M...	- 573w x 27d x 375h

Finishes:	Fabric System Screens with or without Management Rail (suffix ...F) Acrylic System Screens with or without Management Rail (suffix ...A) MFC System Screens without Management Rail (suffix ...MFC) MFC System Screens with Management Rail (suffix .../MFC)
------------------	---

Additional: 4 way link post is required (ELP375)



ESSERC16F



Fabric and MFC Finishes

Elite Desk Mounted End Return System Screen for Workstations Desks

- Standard lead time. • 4 way link post is required (ELP375). • Curved or wave dividing screens with aluminium trim.
- Screen is fixed to the link post at one end and is bracketed to the desk tops at the other.

Curved System Screen

ESSERC18...	- 1773w x 27d x 375h
ESSERC16...	- 1573w x 27d x 375h
ESSERC14...	- 1373w x 27d x 375h
ESSERC12...	- 1173w x 27d x 375h
ESSERC10...	- 973w x 27d x 375h
ESSERC8...	- 773w x 27d x 375h

Wave System Screen

ESSERW18...	- 1773w x 27d x 375h
ESSERW16...	- 1573w x 27d x 375h
ESSERW14...	- 1373w x 27d x 375h
ESSERW12...	- 1173w x 27d x 375h
ESSERW10...	- 973w x 27d x 375h
ESSERW8...	- 773w x 27d x 375h

Finishes:	Fabric System Screens (suffix ...F) MFC System Screens (suffix ...MFC)
------------------	---

Additional: 4 way link post is required (ELP375)

Screens

Desk Mounted System and Acoustic Screens

Fabric:	Fully upholstered with pinnable surface - See below for pricing groups
Acrylic:	Available in Blue, Green, Orange, Red, Frosted and Clear
MFC:	Available in Ash, Autumn Cherry, Beech, Chester Oak, English Walnut, Grey, Grey Nebraska Oak, Laurentii Wenge, Natural Nebraska Oak and White
Metalwork:	Anodised Silver, Black Graphite and White
Fabric Groups:	Group 1 - Add surcharge for Group 2-7



ESSPR16F

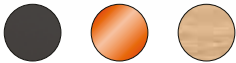

Fabric, Acrylic and MFC Finishes

Elite Desk Mounted Ped Return System Screen for Workstations Desks

- Standard lead time. • 4 way link post is required (ELP375).
- Straight dividing screens with aluminium trim and optional management rail.
- Screen is fixed to the link post at one end and is bracketed to the desk tops at the other before the pedestal.
- Available as Hygiene Protection Screens and add-ons (see HPS Guide).
- Optional screen mounted accessories available (page 293).

Straight System Screen

ESSPR16... - 1592w x 27d x 375h

Straight System Screen with Management Rail

ESSPR16M... - 1592w x 27d x 375h

Finishes: Fabric System Screens with or without Management Rail (suffix ...F)
Acrylic System Screens with or without Management Rail (suffix ...A)
MFC System Screens without Management Rail (suffix ...MFC)
MFC System Screens with Management Rail (suffix .../MFC)

Additional: 4 way link post is required (ELP375)



ESSPRC16F



Fabric and MFC Finishes

Elite Desk Mounted Ped Return System Screen for Workstations Desks

- Standard lead time. • 4 way link post is required (ELP375).
- Curved and wave dividing screens with aluminium trim.
- Screen is fixed to the link post at one end and is bracketed to the desk tops at the other before the pedestal.

Curved System Screen

ESSPRC16... - 1592w x 27d x 375h

Wave System Screen

ESSPRW16... - 1592w x 27d x 375h

Finishes: Fabric System Screens (suffix ...F)
MFC System Screens (suffix ...MFC)

Additional: 4 way link post is required (ELP375)



AESS16F



Fabric Finish

Elite Desk Mounted Acoustic Screen for Workstations Desks

- Standard lead time. • Straight dividing screens faced with 6mm polyester fibre insulation board.
- Screen is bracketed to the outer edge of the desk top. • Link post not required.
- Available as Hygiene Protection Screens and add-ons (see HPS Guide).
- Class B certified in accordance with International Standards: ISO 354:2003, ISO 11654:1997 and ISO 9613-1:1993

Straight Acoustic Screen

AESS20F - 1973w x 38d x 375h

AESS18F - 1773w x 38d x 375h

AESS16F - 1573w x 38d x 375h

AESS14F - 1373w x 38d x 375h

AESS12F - 1173w x 38d x 375h

AESS10F - 973w x 38d x 375h

AESS8F - 773w x 38d x 375h

Compatibility: For use **without** Power Modules and Monitor Arms with brackets (no suffix)
For use **with** Power Modules and Monitor Arms with brackets (creates a minimum 12mm void) (suffix .../V)

Screens

Desk Mounted Contract Screens

Fabric: Fully upholstered non-pinnable surface - See below for pricing groups

Fabric Groups: Group 1 - Add surcharge for Group 2-7



ECS16F



Fabric Finish

Elite Desk Mounted Contract Screen for Single Workstations

- Standard lead time.
- Straight, curved and wave dividing screens.
- Screen is bracketed to the outer edge of the desk top.
- Link post not required.
- Available as Hygiene Protection Screens and add-ons (see HPS Guide).

Straight Contract Screen

- ECS18F...** - 1770w x 27d x 375h
- ECS16F...** - 1570w x 27d x 375h
- ECS14F...** - 1370w x 27d x 375h
- ECS12F...** - 1170w x 27d x 375h
- ECS10F...** - 970w x 27d x 375h
- ECS8F...** - 770w x 27d x 375h

Curved Contract Screen

- ECSC18F...** - 1770w x 27d x 375h
- ECSC16F...** - 1570w x 27d x 375h
- ECSC14F...** - 1370w x 27d x 375h
- ECSC12F...** - 1170w x 27d x 375h
- ECSC10F...** - 970w x 27d x 375h
- ECSC8F...** - 770w x 27d x 375h

Wave Contract Screen

- ECSW18F...** - 1770w x 27d x 375h
- ECSW16F...** - 1570w x 27d x 375h
- ECSW14F...** - 1370w x 27d x 375h
- ECSW12F...** - 1170w x 27d x 375h
- ECSW10F...** - 970w x 27d x 375h
- ECSW8F...** - 770w x 27d x 375h

Compatibility: For use with back to back single desks (no suffix)
For use with stand alone single desks (suffix **.../X**)
For use **without** Power Modules and Monitor Arms with brackets (no suffix)
For use **with** Power Modules and Monitor Arms with brackets (creates a minimum 12mm void) (suffix **.../V**)



Screens

Desk Mounted Contract Screens

Fabric: Fully upholstered non-pinnable surface - See below for pricing groups
Metalwork: Anodised Silver, Black Graphite and White
Fabric Groups: Group 1 - Add surcharge for Group 2-7



ECS120/12F



Fabric Finish

Elite Desk Mounted 120 Degree Contract Screen for 120 Degree Workstations

- Standard lead time. • Straight, curved and wave dividing screens.
- Screen is bracketed to the outer edge of the desk tops. • Link post not required.
- Available as Hygiene Protection Screens and add-ons (see HPS Guide).

Straight Contract Screen

ECS120/12F... - 1185w x 27d x 375h
ECS120/10F... - 985w x 27d x 375h

Curved Contract Screen

ECSC120/12F... - 1185w x 27d x 375h
ECSC120/10F... - 985w x 27d x 375h

Wave Contract Screen

ECSW120/12F... - 1185w x 27d x 375h
ECSW120/10F... - 985w x 27d x 375h

Compatibility: For use with back to back single desks (no suffix)
For use with stand alone single desks (suffix **.../X**)



ECS16F



Fabric Finish

Elite Desk Mounted Ped Return Contract Screen for Single Workstations

- Standard lead time. • Straight, curved and wave dividing screens.
- Screen is bracketed to the outer edge of the desk tops before the pedestal. • Link post not required.
- Available as Hygiene Protection Screens and add-ons (see HPS Guide).

Straight Contract Screen

ECSPR18F... - 1790w x 27d x 375h
ECSPR16F... - 1590w x 27d x 375h
ECSPR14F... - 1390w x 27d x 375h
ECSPR12F... - 1190w x 27d x 375h
ECSPR10F... - 990w x 27d x 375h

Curved Contract Screen

ECSPRC18F... - 1790w x 27d x 375h
ECSPRC16F... - 1590w x 27d x 375h
ECSPRC14F... - 1390w x 27d x 375h
ECSPRC12F... - 1190w x 27d x 375h
ECSPRC10F... - 990w x 27d x 375h

Wave Contract Screen

ECSPRW18F... - 1790w x 27d x 375h
ECSPRW16F... - 1590w x 27d x 375h
ECSPRW14F... - 1390w x 27d x 375h
ECSPRW12F... - 1190w x 27d x 375h
ECSPRW10F... - 990w x 27d x 375h

Compatibility: For use with back to back single desks (no suffix)
For use with stand alone single desks (suffix **.../X**)

Floor Standing Screens

System, Hygiene Protection, Oases, Park and Hush



Floor standing screens are an excellent way to break up working environments, maximising the functionality of the space and surroundings. A range of floor standing screens are available to segregate open areas into flexible work environments that can be reconfigured easily, as the requirement of the space changes. The acoustic properties of the panels support the reduction of noise pollution and transfer to other areas.



Fabric: Fully upholstered with pinnable surface - *See below for pricing groups*
MFC: Available in Ash, Autumn Cherry, Beech, Chester Oak, English Walnut, Grey, Grey Nebraska Oak, Laurentii Wenge, Natural Nebraska Oak and White
Metalwork: Anodised Silver, Black Graphite and White
Fabric Groups: Group 1 - Add surcharge for Group 2-7



EFSS16/15F



Fabric and MFC Finishes

Elite Floor Standing System Screen

- 2 week lead time.
- Straight floor standing screens with aluminium trim and optional management rail.
- Screen is fixed to the link post at either end or support foot can be used for stability.
- Optional 4 and 3 way link posts available (page 277).
- Optional support foot available (page 277).
- Available as Hygiene Protection Screens (see HPS Guide).
- Optional screen mounted accessories available (page 293).

Straight System Screen

- EFSS16/17...** - 1573w x 27d x 1700h
- EFSS14/17...** - 1373w x 27d x 1700h
- EFSS12/17...** - 1173w x 27d x 1700h
- EFSS10/17...** - 973w x 27d x 1700h
- EFSS8/17...** - 773w x 27d x 1700h

- EFSS18/15...** - 1773w x 27d x 1500h
- EFSS16/15...** - 1573w x 27d x 1500h
- EFSS14/15...** - 1373w x 27d x 1500h
- EFSS12/15...** - 1173w x 27d x 1500h
- EFSS10/15...** - 973w x 27d x 1500h
- EFSS8/15...** - 773w x 27d x 1500h

- EFSS18/13...** - 1773w x 27d x 1300h
- EFSS16/13...** - 1573w x 27d x 1300h
- EFSS14/13...** - 1373w x 27d x 1300h
- EFSS12/13...** - 1173w x 27d x 1300h
- EFSS10/13...** - 973w x 27d x 1300h
- EFSS8/13...** - 773w x 27d x 1300h

- EFSS18/11...** - 1773w x 27d x 1115h
- EFSS16/11...** - 1573w x 27d x 1115h
- EFSS14/11...** - 1373w x 27d x 1115h
- EFSS12/11...** - 1173w x 27d x 1115h
- EFSS10/11...** - 973w x 27d x 1115h
- EFSS8/11...** - 773w x 27d x 1115h

Straight System Screen with Management Rail

- EFSS18/13M...** - 1773w x 27d x 1300h
- EFSS16/13M...** - 1573w x 27d x 1300h
- EFSS14/13M...** - 1373w x 27d x 1300h
- EFSS12/13M...** - 1173w x 27d x 1300h
- EFSS10/13M...** - 973w x 27d x 1300h
- EFSS8/13M...** - 773w x 27d x 1300h

- EFSS18/11M...** - 1773w x 27d x 1115h
- EFSS16/11M...** - 1573w x 27d x 1115h
- EFSS14/11M...** - 1373w x 27d x 1115h
- EFSS12/11M...** - 1173w x 27d x 1115h
- EFSS10/11M...** - 973w x 27d x 1115h
- EFSS8/11M...** - 773w x 27d x 1115h

Finishes: Fabric System Screens with or without Management Rail (suffix ...F)
 Acrylic System Screens with or without Management Rail (suffix ...A)
 MFC System Screens without Management Rail (suffix ...MFC)
 MFC System Screens with Management Rail (suffix .../MFC)

Additional: Optional 4 way link post (EFLP..., page 275)

Screens

Floor Standing System Screens

2 Week Lead Time

Fabric: Fully upholstered with pinnable surface - *See below for pricing groups*
MFC: Available in Ash, Autumn Cherry, Beech, Chester Oak, English Walnut, Grey, Grey Nebraska Oak, Laurentii Wenge, Natural Nebraska Oak and White
Metalwork: Anodised Silver, Black Graphite and White
Fabric Groups: Group 1 - Add surcharge for Group 2-7



EFSS16/15F/C



Fabric and MFC Finishes

Elite Floor Standing System Screen

- 2 week lead time.
- Curved and wave floor standing screens with aluminium trim.
- Screen is fixed to the link post at either end or support foot can be used for stability.
- Optional 4 and 3 way link posts available (page 277).
- Optional support foot available (page 277).

Curved and Wave System Screen

- EFSS16/17...** - 1573w x 27d x 1700h
EFSS14/17... - 1373w x 27d x 1700h
EFSS12/17... - 1173w x 27d x 1700h
EFSS10/17... - 973w x 27d x 1700h

- EFSS18/15...** - 1773w x 27d x 1500h
EFSS16/15... - 1573w x 27d x 1500h
EFSS14/15... - 1373w x 27d x 1500h
EFSS12/15... - 1173w x 27d x 1500h
EFSS10/15... - 973w x 27d x 1500h

- EFSS18/13...** - 1773w x 27d x 1300h
EFSS16/13... - 1573w x 27d x 1300h
EFSS14/13... - 1373w x 27d x 1300h
EFSS12/13... - 1173w x 27d x 1300h
EFSS10/13... - 973w x 27d x 1300h

- EFSS18/11...** - 1773w x 27d x 1115h
EFSS16/11... - 1573w x 27d x 1115h
EFSS14/11... - 1373w x 27d x 1115h
EFSS12/11... - 1173w x 27d x 1115h
EFSS10/11... - 973w x 27d x 1115h

Finishes: Curved Fabric System Screens (suffix ...F/C)
 Curved MFC System Screens (suffix ...MFC/C)
 Wave Fabric System Screens (suffix ...F/W)
 Wave MFC System Screens (suffix ...MFC/W)

Additional: Optional 4 way link post (EFLP..., page 275)



Screens

Floor Standing System Screens

2 Week Lead Time

Fabric: Fully upholstered with pinnable surface - See below for pricing groups
MFC: Available in Ash, Autumn Cherry, Beech, Chester Oak, English Walnut, Grey, Grey Nebraska Oak, Laurentii Wenge, Natural Nebraska Oak and White
Acrylic: Available in Blue, Green, Orange, Red, Frosted and Clear
Metalwork: Anodised Silver, Black Graphite and White
Fabric Groups: Group 1 - Add surcharge for Group 2-7



EFSS16/15F/A

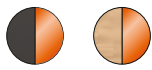

Fabric / Acrylic and MFC / Acrylic Finishes

Elite Floor Standing System Screen with Acrylic Top Section

- 2 week lead time.
- Straight floor standing screens with aluminium trim and acrylic top section.
- Screen is fixed to the link post at either end or support foot can be used for stability.
- Optional 4 and 3 way link posts available (page 277).
- Optional support foot available (page 277).

Straight System Screen

EFSS18/17... - 1773w x 27d x 1700h
EFSS16/17... - 1573w x 27d x 1700h
EFSS14/17... - 1373w x 27d x 1700h
EFSS12/17... - 1173w x 27d x 1700h
EFSS10/17... - 973w x 27d x 1700h
EFSS8/17... - 773w x 27d x 1700h

EFSS18/15... - 1773w x 27d x 1500h
EFSS16/15... - 1573w x 27d x 1500h
EFSS14/15... - 1373w x 27d x 1500h
EFSS12/15... - 1173w x 27d x 1500h
EFSS10/15... - 973w x 27d x 1500h
EFSS8/15... - 773w x 27d x 1500h

EFSS18/13... - 1773w x 27d x 1300h
EFSS16/13... - 1573w x 27d x 1300h
EFSS14/13... - 1373w x 27d x 1300h
EFSS12/13... - 1173w x 27d x 1300h
EFSS10/13... - 973w x 27d x 1300h
EFSS8/13... - 773w x 27d x 1300h

EFSS18/11... - 1773w x 27d x 1115h
EFSS16/11... - 1573w x 27d x 1115h
EFSS14/11... - 1373w x 27d x 1115h
EFSS12/11... - 1173w x 27d x 1115h
EFSS10/11... - 973w x 27d x 1115h
EFSS8/11... - 773w x 27d x 1115h

Finishes: Fabric and Acrylic System Screens (suffix ...F/A)
MFC and Acrylic System Screens (suffix ...MFC/A)

Additional: Optional 4 way link post (EFLP..., page 275)

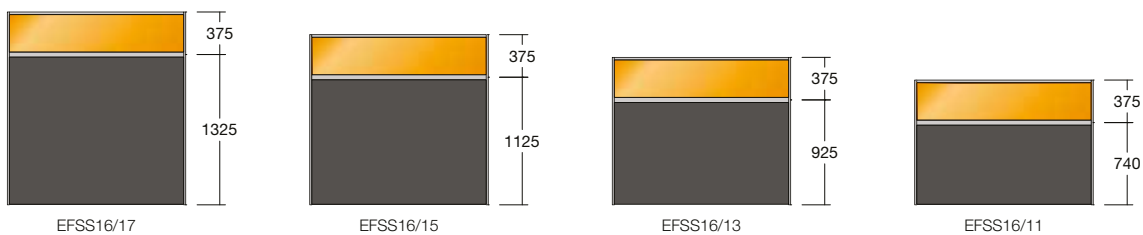

The above illustrations show the fabric / MFC and acrylic portions of the Elite half glazed floor standing system screen as standard.
For alternative sizes, contact sales.

Screens

Floor Standing System Screen Accessories

Fabric: Fully upholstered with pinnable surface - See below for pricing groups
MFC: Available in Ash, Autumn Cherry, Beech, Chester Oak, English Walnut, Grey, Grey Nebraska Oak, Laurentii Wenge, Natural Nebraska Oak and White
Metalwork: Anodised Silver, Black Graphite and White



EFLP15

Elite Floor Standing System Screen Linking Posts

• Standard lead time. • For Elite floor standing system screens only.

4 Way Linking Post

- EFLP17** - For 1700h Screens - 27w x 27d x 1700h
- EFLP15** - For 1500h Screens - 27w x 27d x 1500h
- EFLP13** - For 1300h Screens - 27w x 27d x 1300h
- EFLP11** - For 1115h Screens - 27w x 27d x 1115h
- EFLP9** - For 915h Screens - 27w x 27d x 915h

3 Way Linking Post

- EFLP17/120** - For 1700h Screens - 27w x 27d x 1700h
- EFLP15/120** - For 1500h Screens - 27w x 27d x 1500h
- EFLP13/120** - For 1300h Screens - 27w x 27d x 1300h
- EFLP11/120** - For 1115h Screens - 27w x 27d x 1115h
- EFLP9/120** - For 915h Screens - 27w x 27d x 915h



ESF1

Elite Floor Standing Screen Support Foot

• Standard lead time. • For Elite floor standing system screens only.

ESF1 - Sold Individually



ELB

Elite Floor Standing Screen Support Bracket

• Standard lead time. • For Elite floor standing system screens only.

ELB - Sold in Pairs

Oases

Agile Working Solutions

Contact Customer Services for more information

Oases Introduction

As workspaces evolve, there has been a rapid transition towards agile and hybrid working. This developing concept focusses on providing flexible environments for employees, allowing them to choose from a variety of settings according to the nature of what they are doing.

Oases' diverse range of flexible configurations offer modular solutions for single workspaces, one-to-one zones, instant dropdown points and soft seating for developing agile and focused workspaces.



- Metalwork Legs:** Silver (.../SF), Black Graphite (.../BGF) and White (.../WF)
 Add surcharge per foot for Chrome Effect (.../CF), Raw Metalwork (.../RF), Black (.../BF), Praline (.../PLF), Olive Green (.../OVF), Atlantic Blue (.../ABF), Sapphire Blue (.../SBF), Mustard Yellow (.../MYF), Terracotta (.../TCF) and Conker Brown (.../CBF)
- Veneer Legs:** Add surcharge per foot for Ash (.../ASL), Beech (.../BEL), Stained Walnut (.../WAL), Stained Espresso (.../ESL), Stained Wenge (.../WEL), Stained Black (.../BKL), Stained Grey (.../GYL) and White (.../WHF)
- Fabric:** Screens are fully upholstered with pinnable surface
 Screens available in Two-Tone (suffix .../TT after leg finish) - *Further information required, contact Customer Services for an Oases specification form*
- Electrics:** Cut-outs available for Electrics (suffix .../EA after leg finish) - *Further information required, contact Customer Services for an Oases specification form*



OAS/A20/24/13...

Open Booth in Style A

- 6 week lead time.

OAS/A10/14/7...	- 1 Person	- 6x Feet	- 1400w x 700d x 1440h
OAS/A10/12/7...	- 1 Person	- 6x Feet	- 1200w x 700d x 1440h
OAS/A10/10/7...	- 1 Person	- 6x Feet	- 1000w x 700d x 1440h
OAS/A10/14/12...	- 1 Person	- 10x Feet	- 1400w x 1217d x 1440h
OAS/A10/12/12...	- 1 Person	- 10x Feet	- 1200w x 1217d x 1440h
OAS/A10/10/12...	- 1 Person	- 10x Feet	- 1000w x 1217d x 1440h
OAS/A20/28/13...	- 2 Person	- 16x Feet	- 2764w x 1400d x 1440h
OAS/A20/24/13...	- 2 Person	- 16x Feet	- 2364w x 1400d x 1440h
OAS/A20/20/13...	- 2 Person	- 16x Feet	- 1964w x 1400d x 1440h
OAS/A30/42/13...	- 3 Person	- 22x Feet	- 4128w x 1400d x 1440h
OAS/A30/36/13...	- 3 Person	- 22x Feet	- 3528w x 1400d x 1440h
OAS/A30/30/13...	- 3 Person	- 22x Feet	- 2928w x 1400d x 1440h
OAS/A40/56/13...	- 4 Person	- 28x Feet	- 5492w x 1400d x 1440h
OAS/A40/48/13...	- 4 Person	- 28x Feet	- 4692w x 1400d x 1440h
OAS/A40/40/13...	- 4 Person	- 28x Feet	- 3892w x 1400d x 1440h



OAS/B20/22/9...

Open Booth in Style B

- 6 week lead time.
- 900w, 1800w, 2700w and 3600w versions have single back panels.

OAS/B10/13/9...	- 1 Person	- 8x Feet	- 1314w x 857d x 1440h
OAS/B10/11/9...	- 1 Person	- 8x Feet	- 1114w x 857d x 1440h
OAS/B10/9/9...	- 1 Person	- 6x Feet	- 897w x 857d x 1440h
OAS/B20/26/9...	- 2 Person	- 14x Feet	- 2588w x 857d x 1440h
OAS/B20/22/9...	- 2 Person	- 14x Feet	- 2188w x 857d x 1440h
OAS/B20/18/9...	- 2 Person	- 10x Feet	- 1754w x 857d x 1440h
OAS/B30/39/9...	- 3 Person	- 20x Feet	- 3862w x 857d x 1440h
OAS/B30/33/9...	- 3 Person	- 20x Feet	- 3262w x 857d x 1440h
OAS/B30/27/9...	- 3 Person	- 14x Feet	- 2611w x 857d x 1440h
OAS/B40/52/9...	- 4 Person	- 26x Feet	- 5136w x 857d x 1440h
OAS/B40/44/9...	- 4 Person	- 26x Feet	- 4336w x 857d x 1440h
OAS/B40/36/9...	- 4 Person	- 18x Feet	- 3468w x 857d x 1440h



OAS/C20/22/17...

Open Booth in Style C

- 6 week lead time.
- 900w, 1800w, 2700w and 3600w versions have single back panels.

OAS/C20/13/17...	- 2 Person	- 12x Feet	- 1314w x 1674d x 1440h
OAS/C20/11/17...	- 2 Person	- 12x Feet	- 1114w x 1674d x 1440h
OAS/C20/9/17...	- 2 Person	- 10x Feet	- 897w x 1674d x 1440h
OAS/C40/26/17...	- 4 Person	- 20x Feet	- 2588w x 1674d x 1440h
OAS/C40/22/17...	- 4 Person	- 20x Feet	- 2188w x 1674d x 1440h
OAS/C40/18/17...	- 4 Person	- 16x Feet	- 1754w x 1674d x 1440h
OAS/C60/39/17...	- 6 Person	- 28x Feet	- 3862w x 1674d x 1440h
OAS/C60/33/17...	- 6 Person	- 28x Feet	- 3262w x 1674d x 1440h
OAS/C60/27/17...	- 6 Person	- 22x Feet	- 2611w x 1674d x 1440h
OAS/C80/52/17...	- 8 Person	- 36x Feet	- 5136w x 1674d x 1440h
OAS/C80/44/17...	- 8 Person	- 36x Feet	- 4336w x 1674d x 1440h
OAS/C80/36/17...	- 8 Person	- 28x Feet	- 3468w x 1674d x 1440h

- Metalwork Legs:** Silver (.../SF), Black Graphite (.../BGF) and White (.../WF)
 Add surcharge per foot for Chrome Effect (.../CF), Raw Metalwork (.../RF), Black (.../BF), Praline (.../PLF), Olive Green (.../OVF), Atlantic Blue (.../ABF), Sapphire Blue (.../SBF), Mustard Yellow (.../MYF), Terracotta (.../TCF) and Conker Brown (.../CBF)
- Veneer Legs:** Add surcharge per foot for Ash (.../ASL), Beech (.../BEL), Stained Walnut (.../WAL), Stained Espresso (.../ESL), Stained Wenge (.../WEL), Stained Black (.../BKL), Stained Grey (.../GYL) and White (.../WHF)
- Fabric:** Screens are fully upholstered with pinnable surface
 Screens available in Two-Tone (suffix .../TT after leg finish) - *Further information required, contact Customer Services for an Oases specification form*
- Electrics:** Cut-outs available for Electrics (suffix .../EA after leg finish) - *Further information required, contact Customer Services for an Oases specification form*



OAS/D10/16/12...

Open Booth in Style D

- 6 week lead time.

OAS/D10/16/14...	- 1 Person	- 12x Feet	- 1600w x 1400d x 1440h
OAS/D10/16/12...	- 1 Person	- 12x Feet	- 1600w x 1200d x 1440h
OAS/D10/16/10...	- 1 Person	- 12x Feet	- 1600w x 1000d x 1440h



OAS/E20/23/12...

Open Booth in Style E

- 6 week lead time.

OAS/E20/23/14...	- 2 Person	- 14x Feet	- 2317w x 1400d x 1440h
OAS/E20/23/12...	- 2 Person	- 14x Feet	- 2317w x 1200d x 1440h
OAS/E20/23/10...	- 2 Person	- 14x Feet	- 2317w x 1000d x 1440h



OAS/F20/30/12...

Open Booth in Style F

- 6 week lead time.

OAS/F20/30/14...	- 2 Person	- 20x Feet	- 3074w x 1400d x 1440h
OAS/F20/30/12...	- 2 Person	- 20x Feet	- 3074w x 1200d x 1440h
OAS/F20/30/10...	- 2 Person	- 20x Feet	- 3074w x 1000d x 1440h
OAS/F40/30/28...	- 4 Person	- 36x Feet	- 2988w x 2674d x 1440h
OAS/F40/30/24...	- 4 Person	- 36x Feet	- 2988w x 2274d x 1440h
OAS/F40/30/20...	- 4 Person	- 36x Feet	- 2988w x 1874d x 1440h



OAS/G30/12...

Open Booth in Style G

- 6 week lead time.

OAS/G30/12...	- 3 Person	- 24x Feet	- 2814w x 2849d x 1440h
OAS/G30/10...	- 3 Person	- 24x Feet	- 2582w x 2676d x 1440h



OAS/H40/12...

Open Booth in Style H

- 6 week lead time.

OAS/H40/14...	- 4 Person	- 32x Feet	- 2874w x 2874d x 1440h
OAS/H40/12...	- 4 Person	- 32x Feet	- 2674w x 2674d x 1440h

- Metalwork Legs:** Silver (.../SF), Black Graphite (.../BGF) and White (.../WF)
 Add surcharge per foot for Chrome Effect (.../CF), Raw Metalwork (.../RF), Black (.../BF), Praline (.../PLF), Olive Green (.../OVF), Atlantic Blue (.../ABF), Sapphire Blue (.../SBF), Mustard Yellow (.../MYF), Terracotta (.../TCF) and Conker Brown (.../CBF)
- Veneer Legs:** Add surcharge per foot for Ash (.../ASL), Beech (.../BEL), Stained Walnut (.../WAL), Stained Espresso (.../ESL), Stained Wenge (.../WEL), Stained Black (.../BKL), Stained Grey (.../GYL) and White (.../WHF)
- Fabric:** Screens are fully upholstered with pinnable surface
 Screens available in Two-Tone (suffix .../TT after leg finish) - *Further information required, contact Customer Services for an Oases specification form*
- Electrics:** Cut-outs available for Electrics (suffix .../EA after leg finish) - *Further information required, contact Customer Services for an Oases specification form*



OAS/J30/38/10...

Open Booth in Style J

- 6 week lead time.

OAS/J20/28/10...	- 2 Person	- 10x Feet	- 2816w x 947d x 1440h
OAS/J20/24/8...	- 2 Person	- 10x Feet	- 2391w x 805d x 1440h
OAS/J30/38/10...	- 3 Person	- 13x Feet	- 3780w x 947d x 1440h
OAS/J30/32/8...	- 3 Person	- 13x Feet	- 3214w x 805d x 1440h
OAS/J40/48/10...	- 4 Person	- 16x Feet	- 4745w x 947d x 1440h
OAS/J40/40/8...	- 4 Person	- 16x Feet	- 4038w x 805d x 1440h
OAS/J50/58/10...	- 5 Person	- 19x Feet	- 5709w x 947d x 1440h
OAS/J50/48/8...	- 5 Person	- 19x Feet	- 4861w x 805d x 1440h



OAS/K30/24/6...

Open Booth in Style K

- 6 week lead time.

OAS/K20/18/6...	- 2 Person	- 6x Feet	- 1804w x 646d x 1440h
OAS/K30/24/6...	- 3 Person	- 8x Feet	- 2410w x 646d x 1440h
OAS/K40/30/6...	- 4 Person	- 10x Feet	- 3016w x 646d x 1440h
OAS/K50/36/6...	- 5 Person	- 12x Feet	- 3622w x 646d x 1440h



OAS/L30/18/18...

Open Booth in Style L

- 6 week lead time.

OAS/L30/18/18...	- 3 Person	- 9x Feet	- 1806w x 1793d x 1440h
-------------------------	------------	-----------	-------------------------

MFC:	Available in Ash, Autumn Cherry, Beech, Chester Oak, English Walnut, Grey, Grey Nebraska Oak, Laurentii Wenge, Natural Nebraska Oak and White
Nanotech:	See Oases Price Guide for more information
Edging:	Add surcharge for Wenge, Black and Plywood Effect per top - <i>Edging on 25mm White MFC only</i>
Metalwork Legs:	Silver (.../SF), Black Graphite (.../BGF) and White (.../WF) Add surcharge per foot for Chrome Effect (.../CF), Raw Metalwork (.../RF), Black (.../BF), Praline (.../PLF), Olive Green (.../OVF), Atlantic Blue (.../ABF), Sapphire Blue (.../SBF), Mustard Yellow (.../MYF), Terracotta (.../TCF) and Conker Brown (.../CBF)
Veneer Legs:	Add surcharge per foot for Ash (.../ASL), Beech (.../BEL), Stained Walnut (.../WAL), Stained Espresso (.../ESL), Stained Wenge (.../WEL), Stained Black (.../BKL), Stained Grey (.../GYL) and White (.../WHF)
Fabric:	Screens are fully upholstered with pinnable surface Screens available in Two-Tone (suffix .../TT after leg finish) - <i>Further information required, contact Customer Services for an Oases specification form</i>
Electrics:	Cut-outs available for Electrics (suffix .../EA after leg finish) - <i>Further information required, contact Customer Services for an Oases specification form</i>



OAS/A2D/24/13...

Desking Booth in Style A

- 6 week lead time.
- 25mm MFC top panels.
- 2 cable ports per 600d desktop.

OAS/A1D/14/7...	- 1 Person	- 6x Feet	- 1400w x 700d x 1440h
OAS/A1D/12/7...	- 1 Person	- 6x Feet	- 1200w x 700d x 1440h
OAS/A1D/10/7...	- 1 Person	- 6x Feet	- 1000w x 700d x 1440h
OAS/A1D/14/12...	- 1 Person	- 10x Feet	- 1400w x 1217d x 1440h
OAS/A1D/12/12...	- 1 Person	- 10x Feet	- 1200w x 1217d x 1440h
OAS/A1D/10/12...	- 1 Person	- 10x Feet	- 1000w x 1217d x 1440h
OAS/A2D/28/13...	- 2 Person	- 16x Feet	- 2764w x 1400d x 1440h
OAS/A2D/24/13...	- 2 Person	- 16x Feet	- 2364w x 1400d x 1440h
OAS/A2D/20/13...	- 2 Person	- 16x Feet	- 1964w x 1400d x 1440h
OAS/A3D/42/13...	- 3 Person	- 22x Feet	- 4128w x 1400d x 1440h
OAS/A3D/36/13...	- 3 Person	- 22x Feet	- 3528w x 1400d x 1440h
OAS/A3D/30/13...	- 3 Person	- 22x Feet	- 2928w x 1400d x 1440h
OAS/A4D/56/13...	- 4 Person	- 28x Feet	- 5492w x 1400d x 1440h
OAS/A4D/48/13...	- 4 Person	- 28x Feet	- 4692w x 1400d x 1440h
OAS/A4D/40/13...	- 4 Person	- 28x Feet	- 3892w x 1400d x 1440h



OAS/B2D/22/9...

Desking Booth in Style B

- 6 week lead time.
- 25mm MFC top panels.
- 2 cable ports per 600d desktop.
- 900w, 1800w, 2700w and 3600w versions have single back panels.

OAS/B1D/13/9...	- 1 Person	- 8x Feet	- 1314w x 857d x 1440h
OAS/B1D/11/9...	- 1 Person	- 8x Feet	- 1114w x 857d x 1440h
OAS/B1D/9/9...	- 1 Person	- 6x Feet	- 897w x 857d x 1440h
OAS/B2D/26/9...	- 2 Person	- 14x Feet	- 2588w x 857d x 1440h
OAS/B2D/22/9...	- 2 Person	- 14x Feet	- 2188w x 857d x 1440h
OAS/B2D/18/9...	- 2 Person	- 10x Feet	- 1754w x 857d x 1440h
OAS/B3D/39/9...	- 3 Person	- 20x Feet	- 3862w x 857d x 1440h
OAS/B3D/33/9...	- 3 Person	- 20x Feet	- 3262w x 857d x 1440h
OAS/B3D/27/9...	- 3 Person	- 14x Feet	- 2611w x 857d x 1440h
OAS/B4D/52/9...	- 4 Person	- 26x Feet	- 5136w x 857d x 1440h
OAS/B4D/44/9...	- 4 Person	- 26x Feet	- 4336w x 857d x 1440h
OAS/B4D/36/9...	- 4 Person	- 18x Feet	- 3468w x 857d x 1440h



OAS/C2D/22/17...

Desking Booth in Style C

- 6 week lead time.
- 25mm MFC top panels.
- 2 cable ports per 600d desktop.
- 900w, 1800w, 2700w and 3600w versions have single back panels.

OAS/C2D/13/17...	- 2 Person	- 12x Feet	- 1314w x 1674d x 1440h
OAS/C2D/11/17...	- 2 Person	- 12x Feet	- 1114w x 1674d x 1440h
OAS/C2D/9/17...	- 2 Person	- 10x Feet	- 897w x 1674d x 1440h
OAS/C4D/26/17...	- 4 Person	- 20x Feet	- 2588w x 1674d x 1440h
OAS/C4D/22/17...	- 4 Person	- 20x Feet	- 2188w x 1674d x 1440h
OAS/C4D/18/17...	- 4 Person	- 16x Feet	- 1754w x 1674d x 1440h
OAS/C6D/39/17...	- 6 Person	- 28x Feet	- 3862w x 1674d x 1440h
OAS/C6D/33/17...	- 6 Person	- 28x Feet	- 3262w x 1674d x 1440h
OAS/C6D/27/17...	- 6 Person	- 22x Feet	- 2611w x 1674d x 1440h
OAS/C8D/52/17...	- 8 Person	- 36x Feet	- 5136w x 1674d x 1440h
OAS/C8D/44/17...	- 8 Person	- 36x Feet	- 4336w x 1674d x 1440h
OAS/C8D/36/17...	- 8 Person	- 28x Feet	- 3468w x 1674d x 1440h

- MFC:** Available in Ash, Autumn Cherry, Beech, Chester Oak, English Walnut, Grey, Grey Nebraska Oak, Laurentii Wenge, Natural Nebraska Oak and White
- Nanotech:** See Oases Price Guide for more information
- Edging:** Add surcharge for Wenge, Black and Plywood Effect per top - *Edging on 25mm White MFC only*
- Metalwork Legs:** Silver (.../SF), Black Graphite (.../BGF) and White (.../WF)
 Add surcharge per foot for Chrome Effect (.../CF), Raw Metalwork (.../RF), Black (.../BF), Praline (.../PLF), Olive Green (.../OVF), Atlantic Blue (.../ABF), Sapphire Blue (.../SBF), Mustard Yellow (.../MYF), Terracotta (.../TCF) and Conker Brown (.../CBF)
- Veneer Legs:** Add surcharge per foot for Ash (.../ASL), Beech (.../BEL), Stained Walnut (.../WAL), Stained Espresso (.../ESL), Stained Wenge (.../WEL), Stained Black (.../BKL), Stained Grey (.../GYL) and White (.../WHF)
- Fabric:** Screens are fully upholstered with pinnable surface
 Screens available in Two-Tone (suffix .../TT after leg finish) - *Further information required, contact Customer Services for an Oases specification form*
- Electrics:** Cut-outs available for Electrics (suffix .../EA after leg finish) - *Further information required, contact Customer Services for an Oases specification form*



OAS/D1D/16/12...

Desking Booth in Style D

- 6 week lead time.
- 25mm MFC top panels.
- 2 cable ports per 600d desktop.

- OAS/D1D/16/14...** - 1 Person - 12x Feet - 1600w x 1400d x 1440h
OAS/D1D/16/12... - 1 Person - 12x Feet - 1600w x 1200d x 1440h
OAS/D1D/16/10... - 1 Person - 12x Feet - 1600w x 1000d x 1440h



OAS/E2D/23/12...

Desking Booth in Style E

- 6 week lead time.
- 25mm MFC top panels.
- 2 cable ports per 600d desktop.

- OAS/E2D/23/14...** - 2 Person - 14x Feet - 2317w x 1400d x 1440h
OAS/E2D/23/12... - 2 Person - 14x Feet - 2317w x 1200d x 1440h
OAS/E2D/23/10... - 2 Person - 14x Feet - 2317w x 1000d x 1440h



OAS/F2D/30/12...

Desking Booth in Style F

- 6 week lead time.
- 25mm MFC top panels.
- 2 cable ports per 600d desktop.

- OAS/F2D/30/14...** - 2 Person - 20x Feet - 3074w x 1400d x 1440h
OAS/F2D/30/12... - 2 Person - 20x Feet - 3074w x 1200d x 1440h
OAS/F2D/30/10... - 2 Person - 20x Feet - 3074w x 1000d x 1440h

- OAS/F4D/30/28...** - 4 Person - 36x Feet - 2988w x 2674d x 1440h
OAS/F4D/30/24... - 4 Person - 36x Feet - 2988w x 2274d x 1440h
OAS/F4D/30/20... - 4 Person - 36x Feet - 2988w x 1874d x 1440h



OAS/G3D/12...

Desking Booth in Style G

- 6 week lead time.
- 25mm MFC top panels.
- 2 cable ports per 600d desktop.

- OAS/G3D/12...** - 3 Person - 24x Feet - 2814w x 2849d x 1440h
OAS/G3D/10... - 3 Person - 24x Feet - 2582w x 2676d x 1440h



OAS/H4D/12...

Desking Booth in Style H

- 6 week lead time.
- 25mm MFC top panels.
- 2 cable ports per 600d desktop.

- OAS/H4D/14...** - 4 Person - 32x Feet - 2874w x 2874d x 1440h
OAS/H4D/12... - 4 Person - 32x Feet - 2674w x 2674d x 1440h

MFC:	Available in Ash, Autumn Cherry, Beech, Chester Oak, English Walnut, Grey, Grey Nebraska Oak, Laurentii Wenge, Natural Nebraska Oak and White
Nanotech:	See Oases Price Guide for more information
Edging:	Add surcharge for Wenge, Black and Plywood Effect per top - <i>Edging on 25mm White MFC only</i>
Metalwork Legs:	Silver (.../SF), Black Graphite (.../BGF) and White (.../WF) Add surcharge per foot for Chrome Effect (.../CF), Raw Metalwork (.../RF), Black (.../BF), Praline (.../PLF), Olive Green (.../OVF), Atlantic Blue (.../ABF), Sapphire Blue (.../SBF), Mustard Yellow (.../MYF), Terracotta (.../TCF) and Conker Brown (.../CBF)
Veneer Legs:	Add surcharge per foot for Ash (.../ASL), Beech (.../BEL), Stained Walnut (.../WAL), Stained Espresso (.../ESL), Stained Wenge (.../WEL), Stained Black (.../BKL), Stained Grey (.../GYL) and White (.../WHF)
Fabric:	Screens are fully upholstered with pinnable surface Screens available in Two-Tone (suffix .../TT after leg finish) - <i>Further information required, contact Customer Services for an Oases specification form</i>
Electrics:	Cut-outs available for Electrics (suffix .../EA after leg finish) - <i>Further information required, contact Customer Services for an Oases specification form</i>



OAS/J3D/38/10...

Desking Booth in Style J

- 6 week lead time.
- 25mm MFC top panels.
- 1 cable port per desktop.

OAS/J2D/28/10... - 2 Person - 10x Feet - 2816w x 947d x 1440h

OAS/J2D/24/8... - 2 Person - 10x Feet - 2391w x 805d x 1440h

OAS/J3D/38/10... - 3 Person - 13x Feet - 3780w x 947d x 1440h

OAS/J3D/32/8... - 3 Person - 13x Feet - 3214w x 805d x 1440h

OAS/J4D/48/10... - 4 Person - 16x Feet - 4745w x 947d x 1440h

OAS/J4D/40/8... - 4 Person - 16x Feet - 4038w x 805d x 1440h

OAS/J5D/58/10... - 5 Person - 19x Feet - 5709w x 947d x 1440h

OAS/J5D/48/8... - 5 Person - 19x Feet - 4861w x 805d x 1440h



OAS/K3D/24/6...

Desking Booth in Style K

- 6 week lead time.
- 25mm MFC top panels.
- 1 cable port per desktop.

OAS/K2D/18/6... - 2 Person - 6x Feet - 1804w x 646d x 1440h

OAS/K3D/24/6... - 3 Person - 8x Feet - 2410w x 646d x 1440h

OAS/K4D/30/6... - 4 Person - 10x Feet - 3016w x 646d x 1440h

OAS/K5D/36/6... - 5 Person - 12x Feet - 3622w x 646d x 1440h



OAS/L3D/18/18...

Desking Booth in Style L

- 6 week lead time.
- 25mm MFC top panels.
- 3 cable ports per desktop.

OAS/L3D/18/18... - 3 Person - 9x Feet - 1806w x 1793d x 1440h

- Metalwork Legs:** Silver (.../SF), Black Graphite (.../BGF) and White (.../WF)
 Add surcharge per foot for Chrome Effect (.../CF), Raw Metalwork (.../RF), Black (.../BF), Praline (.../PLF), Olive Green (.../OVF), Atlantic Blue (.../ABF), Sapphire Blue (.../SBF), Mustard Yellow (.../MYF), Terracotta (.../TCF) and Conker Brown (.../CBF)
- Veneer Legs:** Add surcharge per foot for Ash (.../ASL), Beech (.../BEL), Stained Walnut (.../WAL), Stained Espresso (.../ESL), Stained Wenge (.../WEL), Stained Black (.../BKL), Stained Grey (.../GYL) and White (.../WHF)
- Fabric:** Screens are fully upholstered with pinnable surface
 Screens available in Two-Tone (suffix .../TT after leg finish) - *Further information required, contact Customer Services for an Oases specification form*
- Electrics:** Cut-outs available for Electrics (suffix .../EA after leg finish) - *Further information required, contact Customer Services for an Oases specification form*



OAS/A20/24/13...

Seating Booth in Style A

- 6 week lead time.

OAS/A1S/14/7...	- 1 Person	- 6x Feet	- 1400w x 700d x 1440h
OAS/A1S/12/7...	- 1 Person	- 6x Feet	- 1200w x 700d x 1440h
OAS/A1S/10/7...	- 1 Person	- 6x Feet	- 1000w x 700d x 1440h
OAS/A1S/14/12...	- 1 Person	- 10x Feet	- 1400w x 1217d x 1440h
OAS/A1S/12/12...	- 1 Person	- 10x Feet	- 1200w x 1217d x 1440h
OAS/A1S/10/12...	- 1 Person	- 10x Feet	- 1000w x 1217d x 1440h
OAS/A2S/28/13...	- 2 Person	- 16x Feet	- 2764w x 1400d x 1440h
OAS/A2S/24/13...	- 2 Person	- 16x Feet	- 2364w x 1400d x 1440h
OAS/A2S/20/13...	- 2 Person	- 16x Feet	- 1964w x 1400d x 1440h
OAS/A3S/42/13...	- 3 Person	- 22x Feet	- 4128w x 1400d x 1440h
OAS/A3S/36/13...	- 3 Person	- 22x Feet	- 3528w x 1400d x 1440h
OAS/A3S/30/13...	- 3 Person	- 22x Feet	- 2928w x 1400d x 1440h
OAS/A4S/56/13...	- 4 Person	- 28x Feet	- 5492w x 1400d x 1440h
OAS/A4S/48/13...	- 4 Person	- 28x Feet	- 4692w x 1400d x 1440h
OAS/A4S/40/13...	- 4 Person	- 28x Feet	- 3892w x 1400d x 1440h



OAS/B2S/22/9...

Seating Booth in Style B

- 6 week lead time.
- 900w, 1800w, 2700w and 3600w versions have single back panels.

OAS/B1S/13/9...	- 1 Person	- 8x Feet	- 1314w x 857d x 1440h
OAS/B1S/11/9...	- 1 Person	- 8x Feet	- 1114w x 857d x 1440h
OAS/B1S/9/9...	- 1 Person	- 6x Feet	- 897w x 857d x 1440h
OAS/B2S/26/9...	- 2 Person	- 14x Feet	- 2588w x 857d x 1440h
OAS/B2S/22/9...	- 2 Person	- 14x Feet	- 2188w x 857d x 1440h
OAS/B2S/18/9...	- 2 Person	- 10x Feet	- 1754w x 857d x 1440h
OAS/B3S/39/9...	- 3 Person	- 20x Feet	- 3862w x 857d x 1440h
OAS/B3S/33/9...	- 3 Person	- 20x Feet	- 3262w x 857d x 1440h
OAS/B3S/27/9...	- 3 Person	- 14x Feet	- 2611w x 857d x 1440h
OAS/B4S/52/9...	- 4 Person	- 26x Feet	- 5136w x 857d x 1440h
OAS/B4S/44/9...	- 4 Person	- 26x Feet	- 4336w x 857d x 1440h
OAS/B4S/36/9...	- 4 Person	- 18x Feet	- 3468w x 857d x 1440h



OAS/C2S/22/17...

Seating Booth in Style C

- 6 week lead time.
- 900w, 1800w, 2700w and 3600w versions have single back panels.

OAS/C2S/13/17...	- 2 Person	- 12x Feet	- 1314w x 1674d x 1440h
OAS/C2S/11/17...	- 2 Person	- 12x Feet	- 1114w x 1674d x 1440h
OAS/C2S/9/17...	- 2 Person	- 10x Feet	- 897w x 1674d x 1440h
OAS/C4S/26/17...	- 4 Person	- 20x Feet	- 2588w x 1674d x 1440h
OAS/C4S/22/17...	- 4 Person	- 20x Feet	- 2188w x 1674d x 1440h
OAS/C4S/18/17...	- 4 Person	- 16x Feet	- 1754w x 1674d x 1440h
OAS/C6S/39/17...	- 6 Person	- 28x Feet	- 3862w x 1674d x 1440h
OAS/C6S/33/17...	- 6 Person	- 28x Feet	- 3262w x 1674d x 1440h
OAS/C6S/27/17...	- 6 Person	- 22x Feet	- 2611w x 1674d x 1440h
OAS/C8S/52/17...	- 8 Person	- 36x Feet	- 5136w x 1674d x 1440h
OAS/C8S/44/17...	- 8 Person	- 36x Feet	- 4336w x 1674d x 1440h
OAS/C8S/36/17...	- 8 Person	- 28x Feet	- 3468w x 1674d x 1440h

- Metalwork Legs:** Silver (.../SF), Black Graphite (.../BGF) and White (.../WF)
 Add surcharge per foot for Chrome Effect (.../CF), Raw Metalwork (.../RF), Black (.../BF), Praline (.../PLF), Olive Green (.../OVF), Atlantic Blue (.../ABF), Sapphire Blue (.../SBF), Mustard Yellow (.../MYF), Terracotta (.../TCF) and Conker Brown (.../CBF)
- Veneer Legs:** Add surcharge per foot for Ash (.../ASL), Beech (.../BEL), Stained Walnut (.../WAL), Stained Espresso (.../ESL), Stained Wenge (.../WEL), Stained Black (.../BKL), Stained Grey (.../GYL) and White (.../WHF)
- Fabric:** Screens are fully upholstered with pinnable surface
 Screens available in Two-Tone (suffix .../TT after leg finish) - *Further information required, contact Customer Services for an Oases specification form*
- Electrics:** Cut-outs available for Electrics (suffix .../EA after leg finish) - *Further information required, contact Customer Services for an Oases specification form*



OAS/D1S/16/12...

Seating Booth in Style D

- 6 week lead time.

OAS/D1S/16/14...	- 1 Person	- 12x Feet	- 1600w x 1400d x 1440h
OAS/D1S/16/12...	- 1 Person	- 12x Feet	- 1600w x 1200d x 1440h
OAS/D1S/16/10...	- 1 Person	- 12x Feet	- 1600w x 1000d x 1440h



OAS/E2S/23/12...

Seating Booth in Style E

- 6 week lead time.

OAS/E2S/23/14...	- 2 Person	- 14x Feet	- 2317w x 1400d x 1440h
OAS/E2S/23/12...	- 2 Person	- 14x Feet	- 2317w x 1200d x 1440h
OAS/E2S/23/10...	- 2 Person	- 14x Feet	- 2317w x 1000d x 1440h



OAS/F2S/30/12...

Seating Booth in Style F

- 6 week lead time.

OAS/F2S/30/14...	- 2 Person	- 20x Feet	- 3074w x 1400d x 1440h
OAS/F2S/30/12...	- 2 Person	- 20x Feet	- 3074w x 1200d x 1440h
OAS/F2S/30/10...	- 2 Person	- 20x Feet	- 3074w x 1000d x 1440h
OAS/F4S/30/28...	- 4 Person	- 36x Feet	- 2988w x 2674d x 1440h
OAS/F4S/30/24...	- 4 Person	- 36x Feet	- 2988w x 2274d x 1440h
OAS/F4S/30/20...	- 4 Person	- 36x Feet	- 2988w x 1874d x 1440h



OAS/G3S/12...

Seating Booth in Style G

- 6 week lead time.

OAS/G3S/12...	- 3 Person	- 24x Feet	- 2814w x 2849d x 1440h
OAS/G3S/10...	- 3 Person	- 24x Feet	- 2582w x 2676d x 1440h



OAS/H4S/12...

Seating Booth in Style H

- 6 week lead time.

OAS/H4S/14...	- 4 Person	- 32x Feet	- 2874w x 2874d x 1440h
OAS/H4S/12...	- 4 Person	- 32x Feet	- 2674w x 2674d x 1440h

Screens

Hive Floor Standing Screens

2 Week Lead Time

Fabric: Fully upholstered surface - See below for pricing groups
Add surcharge for Two-Tone Fabric (Back to Back) (suffix .../TT) - Further information required, contact Customer Services for a Hive specification form
MFC: Base available in Ash, Autumn Cherry, Beech, Chester Oak, English Walnut, Grey, Grey Nebraska Oak, Laurentii Wenge, Natural Nebraska Oak and White
Nanotech: Base available in Black (2 Week Lead Time)
Metalwork: Anodised Silver, Black Graphite and White

Fabric Groups: Group 1 - Add surcharge for Group 2-7



HVESS

Hive Straight Floor Standing Screens

- 2 week lead time.
- 6x vertical panels along a straight base.
- Panels can be rotated by turning any individual panel.
- Non-patterned fabrics only.

HVESS/18 - 1100w x 350d x 1800h
HVESS/13 - 1100w x 350d x 1300h



HVECS60/18

Hive 60 Degree Curved Floor Standing Screens

- 2 week lead time.
- 6x vertical panels along a 60 degree curved base.
- Panels can be rotated by turning any individual panel.
- Non-patterned fabrics only.

HVECS60/18 - 1040w x 770d x 1800h
HVECS60/13 - 1040w x 770d x 1300h



HVECS90/18

Hive 90 Degree Curved Floor Standing Screens

- 2 week lead time.
- 6x vertical panels along a 90 degree curved base.
- Panels can be rotated by turning any individual panel.
- Non-patterned fabrics only.

HVECS90/18 - 864w x 864d x 1800h
HVECS90/13 - 864w x 864d x 1300h



Screens

Park Floor Standing Acoustic Screens

6-10 Week Lead Time

Fabric: Fully upholstered with pinnable surface - See items for pricing groups



PAR/S



Fabric Finish

Park Single Small Acoustic Screen

- 6-10 week lead time.
- Small acoustic panel with Oak support frame.

PAR/S - 990w x 290d x 1260h

Finishes: Ochre (Melange) (suffix .../F1), Yellow (Melange) (suffix .../F2), Green (Melange) (suffix .../F3), and Dark Green (Melange) (suffix .../F4) fabric

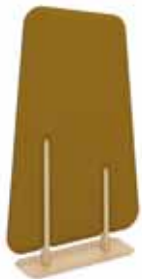

PAR/L



Fabric Finish

Park Single Large Acoustic Screen

- 6-10 week lead time.
- Large acoustic panel with Oak support frame.

PAR/L - 990w x 290d x 1660h

Finishes: Ochre (Melange) (suffix .../F1), Yellow (Melange) (suffix .../F2), Green (Melange) (suffix .../F3), and Dark Green (Melange) (suffix .../F4) fabric



Park Fabric Finishes

- The 4 finishes below are available on the Park acoustic screens above.



Ochre (Melange)
(.../F1)



Yellow (Melange)
(.../F2)



Green (Melange)
(.../F3)



Dark Green (Melange)
(.../F4)

Whilst every effort has been made to ensure accurate colours are illustrated in this document, there may be a slight colour difference due to the printing process, therefore please refer to our colour sample swatches prior to ordering.

Screens

Hush Wall Mounted Acoustic Panels

6-10 Week Lead Time

Fabric: Fully upholstered with pinnable surface - See items for pricing groups



HUS/WM



Fabric Finish

Hush Single Wall Mounted Acoustic Panel

- 6-10 week lead time.
- Reversible acoustic wall panels with timber centre.
- Fixing kit included for wall mounting.

HUS/WM - 590w x 590h

Finishes: Yellow - Orange (suffix .../F1), Green - Dark Green (suffix .../F2), Dark Blue - Blue (suffix .../F3), Red - Cream (suffix .../F4) and Grey - Cream (suffix .../F5) fabric



Hush Fabric Finishes

- The 5 finishes below are available on the Hush acoustic panels above.



Yellow - Orange
(.../F1)



Green - Dark Green
(.../F2)



Dark Blue - Blue
(.../F3)



Red - Cream
(.../F4)



Grey - Cream
(.../F5)

Whilst every effort has been made to ensure accurate colours are illustrated in this document, there may be a slight colour difference due to the printing process, therefore please refer to our colour sample swatches prior to ordering.

Accessories

Power Modules, Monitor Arms, Lighting and General Accessories



Elite have a large portfolio of accessories to complement and enhance the effectiveness and flexibility of our furniture ranges. Accessories for monitor arms, desk mounted electrics, lighting and paper filing systems offer further solutions to improve efficiency. We recognise that the use of smart technology has evolved and our electrical range provides a multitude of solutions to bring power, data and charging facilities to the surface of our desking and table units.



Contact Customer Services for more information

Go Bright Introduction

The dynamic of the workplace has and continues to drastically change, with a widespread movement that offers staff more agility and flexibility in the office.

We have partnered with Europe's #1 software provider to deliver solutions for the future workplace. Go Bright is a user-friendly system for room, desk and visitor management.



GLC1

PC Monitor Glow Light

- Optional accessory for use with Desktop Connect Module.
- Mounts to monitor or partition.
- Displays LED status light for increased visibility around room.

GLC1



WRP-1000-L

Meeting Room Panel

- 10.1" Room panel.
- POE Powered.
- Full LED surround status light.
- Built in NFC reader.
- Includes wall and glass mount.

WRP-1000-L



GB-MAP-001

Mapping Software

- Floorplan license.
- Displays in web portal, mobile app and wayfinder screens.
- On license required per floor/level.

GB-MAP-001



Contact Customer Services for more information



DCF1

Connect Desktop Modules

- Hot desking solution.
- Fits within 80mm desk aperture.
- USB powered.
- Check-in using GoBright mobile app or NFC/RFID cards.
- Height adjustment controls for compatible sit-stand desks.
- Built in RFID reader.
- Requires 1.3m USB cable (CC1-LINAK-USB).
- LED colours indicate status of desk: Green - Available, Red - Occupied, Yellow - About to be occupied, Blue - Do Not Disturb, Purple - Needs cleaning.
- Requires gateway receiver that holds up to 100 connect modules and covers 30m radius, dependant on environment (MGW211-DP28).

DCF1



NFC-DEEP-50MM-MB

NFC Sticker

- 50mm Sticker.
- Hot desking solution.
- Easily deployed, cost effective solution.
- Can be adhered to any surface.
- Check-in using GoBright mobile app.

NFC-DEEP-50MM-MB



DOSC1

Desk Sensor

- Sensor based check in-out.
- Positions to underside of desktop to detect heat and movement.
- Wired using same 1.3m USB cable required for Connect Module.

DOSC1

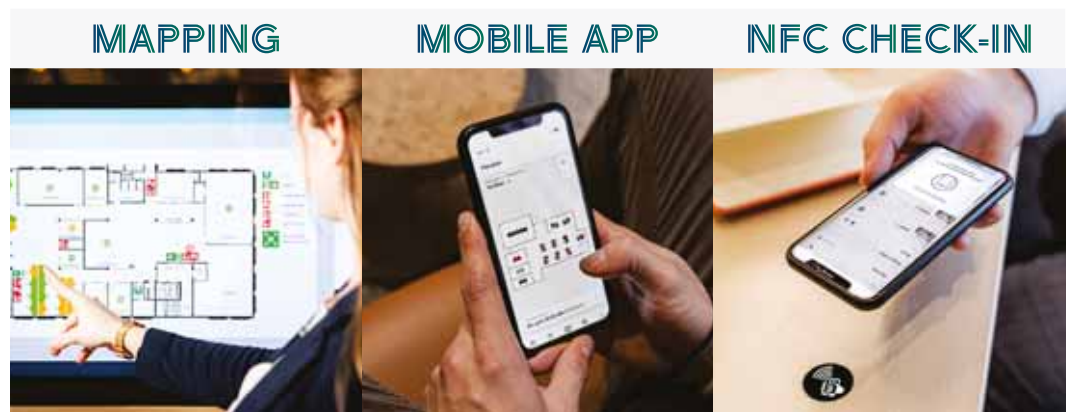

Accessories

Management Rail Mounted Accessories

Finishes: Available in Silver Plastic only



DTFSA

3x A4 In-Pending-Out Trays for System Management Rail Screens

- Standard lead times.
- Moulded plastic.
- Compatible with system screens with management rail.
- Silver plastic only.

DTFSA - 270w x 345d x 260h



DTFSB

Envelope Tray for System Management Rail Screens

- Standard lead times.
- Moulded plastic.
- Compatible with system screens with management rail.
- Silver plastic only.

DTFSB - 385w x 280d x 60h



DTFSC

Stationary Compartments with Removable Items for System Management Rail Screens

- Standard lead times.
- Moulded plastic.
- Compatible with system screens with management rail.
- Silver plastic only.

DTFSC - 380w x 165d x 60h

Accessories

Power Modules

Finishes: **Kaspa:** Available in Silver with Black Inserts, Black with Black Inserts and Matt White with Black Inserts
Prime: Available in Silver with Black Inserts, Black with Black Inserts and Matt White with Black Inserts
Guarantee: 1 Year Guarantee on Electrical Items



POW/KAS/2P1T/S

Kaspa Power and Media Module

- Standard lead time.
- 1x or 2x 3.15 amp individually fused sockets.
- 1x USB twin charger (type A+C).
- Integral colour coded fuse clips.
- 200mm power and connection lead to a Wieland connector.
- Fixing via 135w x 53d (1 gang) or 189w x 53d (2 gang) aperture.
- Requires a separate mains lead if connecting directly into a socket (page 304).

POW/KAS/1P1T... - 1x Power, 1x USB Twin Charger - 151w x 70d

POW/KAS/2P1T... - 2x Power, 1x USB Twin Charger - 204w x 70d

Finishes: Silver (.../S), Black (.../B) and White (.../W)



POW/KAS/1P1T/S
Silver with Black Inserts



POW/KAS/1P1T/B
Black with Black Inserts



POW/KAS/1P1T/W
White with Black Inserts



POW/PRI/2P1T/S

Prime Power and Media Module

- Standard lead time.
- 2x 3.15 amp individually fused sockets.
- 1x USB twin charger (type A+C).
- 200mm power and connection lead to a Wieland connector.
- Fixing via 225w x 60d aperture.
- Requires a separate mains lead if connecting directly into a socket (page 304).

POW/PRI/2P1T... - 2x Power, 1x USB Twin Charger - Without Cover - 241w x 73d

Finishes: Silver (.../S), Black (.../B) and White (.../W)



POW/PRI/2P1T/S
Silver with Black Inserts



POW/PRI/2P1T/B
Black with Black Inserts



POW/PRI/2P1T/W
White with Black Inserts



POW/PRI/2P1T/C/B

Prime Power and Media Module With Cover

- Standard lead time.
- 2x 3.15 amp individually fused sockets.
- 1x USB twin charger (type A+C).
- 200mm power and connection lead to a Wieland connector.
- Fixing via 225w x 60d aperture.
- Casing provided to discretely protect cables and sockets.
- Requires a separate mains lead if connecting directly into a socket (page 304).

POW/PRI/2P1T/C... - 2x Power, 1x USB Twin Charger - With Cover - 257w x 88d

Finishes: Silver (.../S), Black (.../B) and White (.../W)



POW/PRI/2P1T/C/S
Silver with Black Inserts



POW/PRI/2P1T/C/B
Black with Black Inserts



POW/PRI/2P1T/C/W
White with Black Inserts

Finishes: **Boardroom:** Available in Silver with Grey Trim, Black with Black Trim and Matt White with Grey Trim (3 Week Lead Time on Black and White)
Guarantee: 1 Year Guarantee on Electrical Items



PPM2/S

Boardroom Power Module

- 3 week lead time on black and white power modules. • BS6396 compliant. • 2x or 4x 3.15 amp individually fused sockets.
- Fixing via 272w x 132d (2 gang) or 430w x 132d (4 gang) aperture.
- Requires a separate mains lead if connecting directly into a socket (page 304).

PPM2... - 2x Power - 300w x 150d

Finishes: Silver (.../S)
 Add surcharge for Black (.../B) and White (.../W)



PPM4/S

PPM4... - 4x Power - 460w x 150d

Finishes: Silver (.../S)
 Add surcharge for Black (.../B) and White (.../W)



PPMD2/S

Boardroom Power and Data Module

- 3 week lead time on black and white power modules. • BS6396 compliant.
- 2x or 4x 3.15 amp individually fused sockets. • 2x Cat5e data sockets, includes 3 metre data cable.
- Fixing via 272w x 132d (2 gang) or 430w x 132d (4 gang) aperture.
- Requires a separate mains lead if connecting directly into a socket (page 304).

PPMD2... - 2x Power, Data - 300w x 150d

Finishes: Silver (.../S)
 Add surcharge for Black (.../B) and White (.../W)



PPMD4/S

PPMD4... - 4x Power, Data - 460w x 150d

Finishes: Silver (.../S)
 Add surcharge for Black (.../B) and White (.../W)



PPMMD2/S

Boardroom Power, Media and Data Module

- 3 week lead time on black and white power modules. • BS6396 compliant. • 2x or 4x 3.15 amp individually fused sockets.
- 2x Cat5e data sockets, includes 3 metre data cable. • 1x USB twin charger (type A+C).
- 1x VGA and 1x 3.5mm audio stereo connectors. • 1x HDMI 1.3 connector.
- Includes ratchet clips and earthing kit. • Fixing via 272w x 132d (2 gang) or 430w x 132d (4 gang) aperture.
- Requires a separate mains lead if connecting directly into a socket (page 304).

PPMMD2... - 2x Power, Media, Data - 300w x 150d

Finishes: Silver (.../S)
 Add surcharge for Black (.../B) and White (.../W)



PPMMD4/S

PPMMD4... - 4x Power, Media, Data - 460w x 150d

Finishes: Silver (.../S)
 Add surcharge for Black (.../B) and White (.../W)



PPM2/S
 Silver Body with Grey Trim



PPM2/B
 Black Body with Black Trim
 (3 Week Lead Time)



PPM2/W
 White Body with Grey Trim
 (3 Week Lead Time)

Accessories

Power Modules

Finishes:
Guarantee:

Conus: Available in Silver with Black Inserts, Black with Black Inserts and Matt White with Black Inserts
1 Year Guarantee on Electrical Items



POW/CON/2P1D/S

Conus Boardroom Power Module

- **Conus Data Options are required with this product (see below).**
- Standard lead time. • 2x or 4x 3.15 amp individually fused sockets.
- Available with 1x or 2x various additional data options (see below).
- Suffix 1x data option onto 2 Gang versions (e.g. POW/CON/2P1D/S/OP2) and 2x data options onto 4 Gang versions (e.g. POW/CON/4P2D/S/OP1/OP3).
- 200mm power and connection lead to a Wieland connector.
- Fixing via 230w x 138d (2 gang) or 369w x 138d (4 gang) aperture.
- Requires a separate mains lead if connecting directly into a socket (page 304).

POW/CON/2P1D... - 2x Power, 1x Data Blank - 255w x 151d

POW/CON/4P2D... - 4x Power, 2x Data Blanks - 387w x 151d

Finishes: Silver (.../S), Black (.../B) and White (.../W)



POW/CON/2P1D/S
Silver with Black Inserts



POW/CON/2P1D/B
Black with Black Inserts



POW/CON/2P1D/W
Matt White with Black Inserts

Conus Data Options

- Standard lead time. • Suffix 1x data option onto 2 Gang versions (e.g. POW/CON/2P1D/S/OP2) and 2x data options onto 4 Gang versions (e.g. POW/CON/4P2D/S/OP1/OP3).

- .../OP1** - HDMI Module with 3m Tails
- .../OP2** - VGA and 3.5mm Combined Audio Extension Module with 3m Tails
- .../OP3** - USB Twin Charger Module (Type A+C)
- .../OP4** - 2x Cat6A Data Connector Module with 3m Tails
- .../OP5** - Blank Module Plate



.../OP1



.../OP2



.../OP3



.../OP4



.../OP5



Accessories

Power Modules

3 Week Lead Time

Finishes: **Peak:** Available in Stainless Steel Silver with Black Inserts, Black with Black Inserts and Matt White with Grey Inserts (3 Week Lead Time)
Escalate: Available in Silver Only

Guarantee: 1 Year Guarantee on Electrical Items



PEAPM60/W



PEAPM80/B

Peak Power and Media Module

- 3 week lead time.
- 4x or 6x 3.15 amp individually fused sockets.
- 2x USB twin charger (type A+C).
- Integral colour coded fuse clips.
- Hardwired 800mm lead to Wieland connector.
- Includes 4x screw clamps.
- Fixing via 194w x 134d (4 gang) or 274w x 134d (6 gang) aperture.
- Requires a separate mains lead if connecting directly into a socket (page 304).

PEAPM60 - 4x Power, 2x USB Twin Charger - 220w x 155d

Finishes: Silver (.../S)
Add surcharge for Black (.../B) and White (.../W)

PEAPM80 - 6x Power, 2x USB Twin Charger - 300w x 155d

Finishes: Silver (.../S)
Add surcharge for Black (.../B) and White (.../W)



PEAPM60/S
Stainless Steel Silver with Black Inserts



PEAPM80/B
Black with Black Inserts



PEAPM80/W
Matt White with Grey Inserts



Escalate Power and Media Module

- Standard lead time.
- 1x 3.15 amp individually fused socket.
- 1x USB twin charger (type A+A).
- 500mm power and connection lead to Wieland connector.
- Fixing via 80w (dia) porthole aperture.
- Requires a separate mains lead if connecting directly into a socket (page 304).

POW/ESC/1P1T/S - 1x Power, 1x USB Twin Charger - Silver - 95w (dia) x 230h



POW/ESC/1P1T/S



POW/ESC/1P1T/S

Accessories

Power Modules

Finishes:

WCU: Available in Black, Black with Aluminium Trim, Black Glass, White, White with Aluminium Trim and White Glass (3 Week Lead Time)

Dual Pro WCU: Available in Black Glass with Silver Base, White Glass with Silver Base, Black Glass with Black Base and White Glass with Black Base
1 Year Guarantee on Electrical Items

Guarantee:



WCU/BB

Wireless Charging Unit

- Standard lead time. • Charge smartphones and tablets wirelessly. • Fixing via 80w porthole aperture.
- Charging unit complete with 15W USB power plug.
- Wireless Charging Receiver required when device does not support wireless charging.

WCU... - Charging Unit - 85w (dia)

Finishes:

Black (.../BB) and White (.../WW)

Add surcharge for Aluminium Black (.../AB) and Aluminium White (.../AW)

Add surcharge for Black Glass (.../BG) and White Glass (.../WG)



WCU/BB
Black



WCU/AB
Black with Aluminium Trim



WCU/BG
Black Glass



WCU/WW
White



WCU/AW
White with Aluminium Trim



WCU/WG
White Glass



WCU/DP/BGS

Dual Pro Wireless Charging Unit

- Standard lead time. • Lid cover slides to reveal 3x USB chargers (type A+A+C).
- Charge smartphones and tablets wirelessly. • 65W laptop charging without a traditional brick power cord.
- Fixing via 80w porthole aperture. • Charging unit complete with USB power plug.
- Wireless Charging Receiver required when device does not support wireless charging.

WCU/DP... - Dual Pro Charging Unit - 203w x 93d x 8h

Finishes:

Black Glass with Silver Base (.../BGS), White Glass with Silver Base (.../WGS),

Black Glass with Black Base (.../BGB) and White Glass with Black Base (.../WGB)



WCU/DP/BGS
Black Glass with Silver Base



WCU/DP/WGS
White Glass with Silver Base



WCU/DP/BGB
Black Glass with Black Base



WCU/DP/WGB
White Glass with Black Base



WCU/WCR

Wireless Charging Receiver

- Standard lead time. • Charge smartphones and tablets wirelessly.
- Wireless Charging Unit required to support wireless charging.

WCU/WCR - Wireless Charging Receiver

Accessories

Power Modules

Finishes: **Port Hole:** Available in Grey, Black and White
Pix: Available in Black with Silver Trim and White with White Trim
Guarantee: 1 Year Guarantee on Electrical Items



PHPM/G

Port Hole Power and Media Module

- Standard lead time. • 1x 3.15 amp individually fused socket. • 1x USB twin charger (type A+C).
- 1m connection lead. • Fixing via 80w porthole aperture.
- Requires a separate mains lead if connecting directly into a socket (page 304).

PHPM - 1x Power, 1x USB Twin Charger - 95w (dia)

Finishes: Grey (.../G), Black (.../B) and White (.../W)



PHPM/G
Grey



PHPM/B
Black



PHPM/W
White



POW/PIX/1P1T/B

Pix Power and Media Module

- Standard lead time. • 1x 3.15 amp individually fused socket. • 1x USB twin charger (type A+C).
- 800mm connection lead. • Fixing via 80w porthole aperture.
- Requires a separate mains lead if connecting directly into a socket (page 304).

POW/PIX/1P1T... - 1x Power, 1x USB Twin Charger - 90w (dia) x 16h

Finishes: Black (.../B) and White (.../W)



POW/PIX/1P1T/B
Black



POW/PIX/1P1T/W
White



Accessories

Power Modules

Finishes: **Pluto:** Available in Grey with Black Inserts, Black with Grey Inserts and White with Grey Inserts
Inca: Available in Grey, Black and White

Guarantee: 1 Year Guarantee on Electrical Items



PLU/3P/G

Pluto Power Module

- Standard lead time.
- 3.15 amp individually fused sockets.
- Optional USB twin charger (type A+C).
- Fixing via 80w porthole aperture.
- Requires a separate mains lead if connecting directly into a socket (page 304).

PLU/3P... - 3x Power - 140w (dia) x 73h

Finishes: Grey with Black Inserts (.../G), Black with Grey Inserts (.../B) and White with Grey Inserts (.../W)



PLU/2P/1USB/G

PLU/2P/1USB... - 2x Power, 1x USB Twin Charger - 140w (dia) x 73h

Finishes: Grey with Black Inserts (.../G), Black with Grey Inserts (.../B) and White with Grey Inserts (.../W)



PLU/2P/1USB/G
Grey



PLU/2P/1USB/B
Black



PLU/2P/1USB/W
White



IPM/G

Inca Power and Media Module

- Standard lead time.
- 2x 3.15 amp individually fused sockets.
- 2x USB twin chargers (type A+C).
- Power and connection lead to 3 pole connector.
- Fixing via 80w porthole aperture.
- Requires a separate mains lead if connecting directly into a socket (page 304).

IPM... - 2x Power, 2x USB Twin Charger - 140w x 140d x 72h

Finishes: Grey (.../G), Black (.../B) and White (.../W)



IPM/G
Grey



IPM/B
Black



IPM/W
White



Accessories

Power Modules

Finishes: **Flex:** Available in Grey Aluminium with Grey Plastic Ends, Black Plastic with Black Plastic Ends and White Plastic with White Plastic Ends
Boost: Available in Black only
Fixing Clamp: Available in Silver, Black Graphite and White
Guarantee: 1 Year Guarantee on Electrical Items



FDT/2P/W



FDT/1P/2USB/G



FDT/2P/2USB/B



FDT/1P/2USB/G
Grey Aluminium with Grey Plastic Ends



FDT/2P/2USB/B
Black Plastic with Black Plastic Ends



FDT/1P/2USB/W
White Plastic with White Plastic Ends

Flex Desktop Power and Media Module

- Standard lead time.
- 3.15 amp individually fused sockets.
- USB twin charger (type A+C).
- Power and connection lead to 3 pole connector.
- Cables exit from unit back.
- Optional desktop clamps available (see below).
- Requires a separate mains lead if connecting directly into a socket (page 304).

FDT/2P... - 2x Power

Finishes: Black (.../B) and White (.../W)
Add surcharge for Grey (.../G)

FDT/1P/2USB... - 1x Power, 1x USB Twin Charger

Finishes: Black (.../B) and White (.../W)
Add surcharge for Grey (.../G)

FDT/2P/2USB... - 2x Power, 1x USB Twin Charger

Finishes: Black (.../B) and White (.../W)
Add surcharge for Grey (.../G)

Flex Desktop Power Module Fixing Clamp

- Standard lead time.
- Compatible with Flex power modules.
- Clamps modules to chosen desks.

FDPC1 - Flex

For Single Desks: Progress Plus, Progress, Linnea Elevate, Linnea and Matrix single desks. Kassini, Optima Plus, Reflex, Callisto, Windsor, Flexi entire ranges.

FDPC2 - Flex

For Double Bench Desks: Progress Plus, Progress, Progress Lite, Linnea Elevate, Linnea and Matrix double benches.



FDPC1

Boost Desktop Power and Media Module

- Standard lead time.
- 2x 3 amp switched sockets with resettable thermal fuses.
- 1x USB twin charger (type A+A).
- 500mm power and connection lead to 3 pole connector.
- Cables exit from unit back.
- Fixed desktop clamp.
- Requires a separate mains lead if connecting directly into a socket (page 304).

POW/BOO/2P1T/S - 2x Power, 1x USB Twin Charger - Silver



POW/BOO/2P1T/S

Accessories

Power Modules

Finishes: **Capsule:** Available in Black and White
Capsule Plus: Available in Black and White
Fixing Clamp: Available in Silver, Black Graphite and White

Guarantee: 1 Year Guarantee on Electrical Items



CAP/2P/W

Capsule Desktop Power and Media Module - 18w USB Twin Charger

- Standard lead time. • 2x 3 amp switched sockets with resettable thermal fuses. • 1x 18w USB twin charger (type A+C) .
- Able to charge a range of mobile devices. • 2x data blanks. • Power and connection lead to 3 pole connector.
- Cables exit from unit back. • Optional desktop clamps available (see below).
- Requires a separate mains lead if connecting directly into a socket (page 304).

CAP/2P... - 2x Power, 1x USB Twin Charger, 2x Blanks

Finishes: Black (.../B) and White (.../W)



CAP/2P/B
Black



CAP/2P/W
White



CAPP/2P/W

Capsule Plus Desktop Power and Media Module - 65w USB Twin Charger

- Standard lead time. • 2x 3 amp switched sockets with resettable thermal fuses. • 1x 65w USB twin charger (type A+C).
- Able to charge power laptops, tablets and smart phones. • 2x data blanks. • Power and connection lead to 3 pole connector.
- Cables exit from unit back. • Optional desktop clamps available (see below).
- Requires a separate mains lead if connecting directly into a socket (page 304).

CAPP/2P... - 2x Power, 1x USB Twin Charger, 2x Blanks

Finishes: Black (.../B) and White (.../W)



CAPP/2P/B
Black



CAPP/2P/W
White



CAPDPC1

Capsule Desktop Power Module Fixing Clamp

- Standard lead time. • Compatible with Capsule power modules. • Clamps modules to chosen desks.

CAPDPC1 - Capsule

For Single Desks: Progress Plus, Progress, Linnea Elevate, Linnea and Matrix single desks. Kassini, Optima Plus, Reflex, Callisto, Windsor, Flexi entire ranges.

CAPDPC2 - Capsule

For Double Bench Desks: Progress Plus, Progress, Progress Lite, Linnea Elevate, Linnea and Matrix double benches.

Accessories

Power Modules

Finishes: **Plaza:** Available in Black and White
Wieland: Available in Black Only
Fixing Clamp: Available in Silver, Black Graphite and White

Guarantee: 1 Year Guarantee on Electrical Items



POW/PLA/2P1T/B

Plaza Desktop Power and Media Module

- Standard lead time.
- 2x 3 amp sockets with resettable thermal fuses.
- 1x USB twin charger (type A+C).
- 500mm power and connection lead to 3 pole connector.
- Cables exit from unit back.
- Fixed desktop clamp.
- Requires a separate mains lead if connecting directly into a socket (page 304).

POW/PLA/2P1T... - 2x Power, 1x USB Twin Charger

Finishes: Black (.../B) and White (.../W)



POW/PLA/2P1T/B
Black



POW/PLA/2P1T/W
White



PLADPC1

Plaza Desktop Power Module Fixing Clamp

- Standard lead time.
- Compatible with Plaza power modules.
- Clamps modules to chosen desks.

PLADPC1 - Plaza



SK3/U

Wieland Socket Box

- Standard lead time.
- 3.15 amp Individually fused unswitched black sockets.
- Complete with 250mm earth lead to M5 ring terminal.
- Requires a separate mains lead if connecting directly into a socket (page 304).

SK2/U - 2 Gang - 262w x 60d x 50h

SK3/U - 3 Gang - 262w x 60d x 50h

SK4/U - 4 Gang - 315w x 60d x 50h

Accessories

Power Modules



AFK

Adhesive Fixing Kit

- Standard lead time.
- Enables freestanding power modules to be attached to the desk top.
- 1x kit required per module.

AFK



2WA

2 Way Adaptor

- Standard lead time.
- Allows power supply to be split between multiple power modules.

2WA



3WA

3 Way Adaptor

- Standard lead time.
- Allows power supply to be split between multiple power modules.

3WA



5M

Wieland Mains Cable

- Standard lead time.
- Black cable and plug.
- 13amp fused.

7M - 7000mm

5M - 5000mm

3M - 3000mm

2M - 2000mm



CL10

Wieland Interconnection Cable

- Standard lead time.
- Black cable and interconnection plugs.
- Male and female connectors.

CL20 - 2000mm

CL10 - 1000mm

CL5 - 500mm



IEC90/5

IEC 90 Degree Power Cable

- Standard lead time.
- Black cable and plug.
- 13amp fused.

IEC90/7 - 7000mm

IEC90/5 - 5000mm

IEC90/3 - 3000mm

IEC90/2 - 2000mm

Accessories

Monitor Arms



F2LMP

Flex Monitor Arm

- Standard lead time.
- Desk mounted monitor arm with 2x folding links.
- Manual post height adjustment.
- Supports monitors weighing up to 10.0kg.

Manual Post Height Adjustment

F2LMP... - Clamp on Desk Fixing

Manual Post Height Adjustment

F2LMPBT... - Bolt through Desk Fixing

Finishes: silver (no suffix) and White (.../W)



F2LGP

Flex Monitor Arm

- Standard lead time.
- Desk mounted monitor arm with 2x folding links.
- Front end height adjustment.
- Supports monitors weighing up to 10.0kg.

Front End Height Adjustment

F2LGP... - Clamp on Desk Fixing

Front End Height Adjustment

F2LGPBT... - Bolt through Desk Fixing

Finishes: Silver (no suffix) and White (.../W)



F2LGS

Flex Rail Mounted Monitor Arm

- Standard lead time.
- Management rail mounted monitor arm with 2x folding links.
- Front end height adjustment.
- Supports monitors weighing up to 10.0kg.

Front End Height Adjustment

F2LGS... - Management Rail Screen Mounted Clamp

Finishes: Silver (no suffix) and White (.../W)



F4LGP

Flex Dual Monitor Arm

- Standard lead time.
- Desk mounted monitor arm with 2x folding links.
- Manual post and front end height adjustment.
- Supports 2x monitors each weighing up to 10.0kg.

Manual Post and Front End Height Adjustment

F4LGP... - Clamp on Desk Fixing

Finishes: Silver (no suffix) and White (.../W)

Accessories

Monitor Arms



MMA1/B

Maya Monitor Arm

- Desk mounted monitor arm with 2x folding links.
- Gas spring assisted height adjustment.
- Supports monitors weighing up to 9kg.
- Monitor Arm comes with both Clamp On and Bolt Through Desk Fixings.

Gas Spring Assisted Height Adjustment

MMA1... - Clamp on and Bolt Through Desk Fixing

Finishes: Matte White (.../W) and Matte Black (.../B)



MMA2/B

Maya Dual Monitor Arm

- Desk mounted dual monitor arm with 2x arms with 2x folding links each.
- Gas spring assisted height adjustment.
- Supports monitors weighing up to 9kg.
- Monitor Arm comes with both Clamp On and Bolt Through Desk Fixings.

Gas Spring Assisted Height Adjustment

MMA2... - Clamp on and Bolt Through Desk Fixing

Finishes: Matte White (.../W) and Matte Black (.../B)



MMA/LS/B

Maya Laptop Stand for Monitor Arms

- Attaches onto Maya Monitor Arms to provide a safe housing for laptops.
- Includes soft rubber pads.
- Flexible width adjustment.
- Available in Black only.

MMA/LS/B

Accessories

Monitor Arms



MOA/ASC1/S

Ascend Monitor Arm

- Standard lead time. • Desk mounted monitor arm with 2x folding links.
- Gas assisted fingertip adjustment. • Supports monitors weighing 3.0kg - 8.0kg.

Gas Assisted Fingertip Adjustment

MOA/ASC1... - Clamp on Desk Fixing

Finishes: Silver (.../S) and Black (.../B)
Add surcharge for White (.../W)



MOA/ASC1/S

Ascend Rail Mounted Monitor Arm

- Standard lead time. • Management rail mounted monitor arm with 1x folding link.
- Gas assisted fingertip adjustment. • Supports monitors weighing 3.0kg - 8.0kg.

Gas Assisted Fingertip Adjustment

MOA/ASC1RM... - Management Rail Screen Mounted Clamp

Finishes: Silver (.../S) and Black (.../B)
Add surcharge for White (.../W)



MOA/ASC2/S

Ascend Dual Monitor Arm

- Standard lead time. • Desk mounted monitor arm with 2x folding links.
- Gas assisted fingertip adjustment. • Supports 2x monitors each weighing 3.0kg - 8.0kg.

Gas Assisted Fingertip Adjustment

MOA/ASC2... - Clamp on Desk Fixing

Finishes: Silver (.../S) and Black (.../B)
Add surcharge for White (.../W)



MOA/FLO1/S

Flo Monitor Arm

- Standard lead time. • Desk mounted monitor arm with 2x folding links.
- 'Flo Spring Technology' fingertip adjustment. • Supports monitors weighing 3.0kg - 9.0kg.

'Flo Spring Technology' Fingertip Adjustment

MOA/FLO1... - Clamp on Desk Fixing

Finishes: Silver Clamp (.../S), Black Clamp (.../B) and White Clamp (.../W)

Accessories

Monitor Arms



2LM2BS

M2 Monitor Arm

- Standard lead time.
- Desk mounted monitor arm with 2x folding links.
- Extension Spring Assisted adjustment.
- Supports monitors weighing 1.8kg - 9.0kg.

Extension Spring Assisted Adjustment

2LM2C... - Clamp on Desk Fixing

Extension Spring Assisted Adjustment

2LM2B... - Bolt through Desk Fixing

Finishes: Silver (...S) and White (...W)



M8S3WCB

M8 Dual Monitor Arm

- 4 week lead time.
- Not compatible with the Matrix range.
- Desk mounted monitor arm with 2x folding links and crossbar support.
- Extension Spring Assisted adjustment.
- Supports 2x monitors each weighing 1.8kg - 9.0kg.
- Clamp fixing to a 25mm desk top only.

Extension Spring Assisted Adjustment

M8S3... - Clamp on Desk Fixing

Finishes: Silver (...SCB) and White (...WCB)



MOA/OLL1/S

Ollin Monitor Arm

- Standard lead time.
- Desk mounted monitor arm with 2x folding links.
- 'Technical Cord' system adjustment.
- Supports monitors weighing up to 9.0kg.

'Technical Cord' System Adjustment

MOA/OLL1... - Clamp on Desk Fixing

Finishes: Silver (.../S), Black (.../B) and White (.../W)



MOA/OLL2/S

Ollin Dual Monitor Arm

- Standard lead time.
- Desk mounted monitor arm with 2x folding links and crossbar support.
- 'Technical Cord' system adjustment.
- Supports 2x monitors each weighing up to 9.0kg.

Technical Cord System Height Adjustment

MOA/OLL2... - Clamp on Desk Fixing

Finishes: Silver (.../S), Black (.../B) and White (.../W)

Accessories

Lighting



LGT/SUP/BM/S

Supa Lamp

- Standard lead time.
- 10 year, 24/7 warranty.
- Touchstrip dimmable.
- 7 watts energy consumption.
- 3000K (warm white) to 4000K (cool white) colour temperature.
- Energy saving auto off when no movement is detected.

Base Mounted

LGT/SUP/BM... - Base Mounted

Finishes: Grey Base (.../G), Black Base (.../B) and White Base (.../W)



LGT/SUP/RM/S

Management Rail Screen Mounted

LGT/SUP/RM... - Management Rail Screen Mounted

Finishes: Grey Rail Mounted (.../G), Black Rail Mounted (.../B) and White Rail Mounted (.../W)



ZBARS

Mini Z-Bar Lamp

- Standard lead time.
- 1 year warranty.
- Touchstrip dimmable.
- 6.5 watts energy consumption.
- 3500K to 45000K colour temperature.
- Three bar design provides ultimate flexibility.

Base Mounted

ZBAR... - Base Mounted

Finishes: Silver Base (.../S), Black Base (.../B) and White Base (.../W)



ZBARS/RM

Management Rail Screen Mounted

ZBAR... - Management Rail Screen Mounted

Finishes: Silver Rail Mounted (.../S/RM), Black Rail Mounted (.../B/RM) and White Rail Mounted (.../W/RM)



ZBAR/WCU/S

Mini Z-Bar Aircharge Lamp

- Standard lead time.
- 1 year warranty.
- Touchstrip dimmable.
- 7 watts energy consumption.
- 3500K (warm white) to 5000K (daylight) colour temperature.
- In-built wireless charger.
- Three bar design provides ultimate flexibility.

Base Mounted

ZBAR/WCU... - Base Mounted

Finishes: Silver Base (.../S), Black Base (.../B) and White Base (.../W)

Accessories

Various



ET16

Universal Cable Trunking

- Standard lead time.
- 3x channel electrical trunking.
- Black PVC with self adhesive fixing.
- Cables simply push in.
- Suitable for all desking ranges.

ET18 - 1500w x 80d x 22h

ET16 - 1300w x 80d x 22h

ET14 - 1100w x 80d x 22h

ET12 - 900w x 80d x 22h



SCR/S - SCR/B - SCR/W

Slinky Cable Riser

- Standard lead time.
- Suitable for all desking ranges.

SCR...

Finishes: Silver (.../S), Black (.../B) and White Base (.../W)



MCPU

Mobile CPU Holder

- Standard lead time.
- Adjustable bracket to hold 180mm - 240mm wide CPU towers.
- Suitable for all desking ranges.

MCPU



CPUW - CPU

CPU Holder

- Standard lead time.
- Includes mounting kit.
- Adjustable CPU holder for PC towers.
- Rotates a full 360 degrees for complete access to cables and ports.

CPU... - 76-254w x 305-508h

Finishes: Add £0 for Black (no suffix) and White (.../W)



DTM

Desktop Mat

- Standard lead time.
- Heavy duty black polyurethane with 90 degree lipped edge.

DTM - 635w x 465d x 20h



FL

Fixing Link

- Standard lead time.
- Enables freestanding workstation surfaces to be linked together.
- Supplied in packs of 20, including wood screws.

FL - Pack of 20

Accessory Compatibility

- **Black** - Compatible
- **Orange** - Non-standard position required
- **Blue** - Conflict when using screens without .../V
- **Purple** - Conflict when using cable tray
- **Green** - Unspecified
- **Red** - May not support larger modules

	Screens		Monitor Arms													
	Range Screens	Universal Screens	Flex, page 305	Maya (Clamp On), page 306	Maya (Bolt Through), page 306	Ascend, page 307	Flo, page 307	M2, page 308	M8, page 308	Olin, page 308						
Progress Plus - Double Benches	●		●	●	●	●	●	●	●	●	●	●	●	●	●	●
Progress Plus - Rectangular	●	●	●	●	●	●	●	●	●	●	●	●	●	●	●	●
Progress Plus - 120 Degree	●			●	●											
Progress - Double Benches	●		●	●	●	●		●		●						
Progress - Rectangular	●	●	●	●	●	●	●	●	●	●	●	●	●	●	●	●
Progress - 120 Degree	●			●	●											
Progress Lite - Double Benches	●		●	●	●	●	●	●	●	●	●	●	●	●	●	●
Linnea Elevate - Double Benches	●		●	●	●	●	●	●	●	●	●	●	●	●	●	●
Linnea Elevate - Rectangular	●		●	●	●	●	●	●	●	●	●	●	●	●	●	●
Lux - Double Benches	●		●		●			●		●						
Lux - Rectangular		●	●				●	●	●	●	●	●	●	●	●	●
Reflex - Rectangular and Managers		●	●	●	●	●	●	●	●	●	●	●	●	●	●	●
Linnea - Double Benches	●	●	●	●	●	●	●	●	●	●	●	●	●	●	●	●
Linnea - Rectangular, Angular and Secretarial Return	●	●	●	●	●	●	●	●	●	●	●	●	●	●	●	●
Linnea - Radius Reception			●	●	●	●	●	●	●	●	●	●	●	●	●	●
Linnea - 120 Degree Cluster	●		●		●	●	●	●	●	●	●	●	●	●	●	●
Matrix+ - Double Benches	●	●	●	●	●	●	●	●	●	●	●	●	●	●	●	●
Matrix+ - Rectangular and Angular	●	●	●	●	●	●	●	●	●	●	●	●	●	●	●	●
Matrix+ - 120 Degree	●	●	●	●	●	●	●	●	●	●	●	●	●	●	●	●
Matrix+ - Secretarial Return	●	●	●	●	●	●	●	●	●	●	●	●	●	●	●	●
Kassini - Rectangular, 'D' Ended and Radius Executive		●	●	●	●	●	●	●	●	●	●	●	●	●	●	●
Kassini - Bow Fronted Rectangular and Crescent			●	●	●	●	●	●	●	●	●	●	●	●	●	●
Kassini - Crescent, Radius Crescent and Symmetrical Crescent		●	●	●	●	●	●	●	●	●	●	●	●	●	●	●
Kassini - Single and Double Wave		●	●	●	●	●	●	●	●	●	●	●	●	●	●	●
Kassini - 120 Degree		●	●	●	●	●	●	●	●	●	●	●	●	●	●	●
Kassini - Kidney, Radius Reception and Reception			●	●	●	●	●	●	●	●	●	●	●	●	●	●
Kassini - Linking			●	●	●	●	●	●	●	●	●	●	●	●	●	●
Kassini - Secretarial Return		●		●	●											

Accessory Compatibility

- **Black** - Compatible
- **Orange** - Non-standard position required
- **Blue** - Conflict when using screens without .../V
- **Purple** - Conflict when using cable tray
- **Green** - Unspecified
- **Red** - May not support larger modules

	Screens		Monitor Arms													
	Range Screens	Universal Screens	Flex, page 305	Maya (Clamp On), page 306	Maya (Bolt Through), page 306	Ascend, page 307	Flo, page 307	M2, page 308	M8, page 308	Olin, page 308						
Optima Plus - Rectangular, 'D' Ended and Radius Executive	●	●	●	●	●	●	●	●	●	●	●	●	●	●	●	●
Optima Plus - Bow Fronted Rectangular and Crescent			●	●	●	●	●	●	●	●	●	●	●	●	●	●
Optima Plus - Crescent, Radius Crescent and Symmetrical Crescent	●	●	●	●	●	●	●	●	●	●	●	●	●	●	●	●
Optima Plus - Single and Double Wave	●	●	●	●	●	●	●	●	●	●	●	●	●	●	●	●
Optima Plus - 120 Degree	●	●	●	●	●	●	●	●	●	●	●	●	●	●	●	●
Optima Plus - Kidney, Radius Reception and Reception			●	●	●	●	●	●	●	●	●	●	●	●	●	●
Optima Plus - Linking			●	●	●	●	●	●	●	●	●	●	●	●	●	●
Optima Plus - Secretarial Return	●			●	●											
Callisto - Rectangular, 'D' Ended and Radius Executive	●	●	●	●	●	●	●	●	●	●	●	●	●	●	●	●
Callisto - Bow Fronted Rectangular and Crescent			●	●	●	●	●	●	●	●	●	●	●	●	●	●
Callisto - Crescent, Radius Crescent and Symmetrical Crescent	●	●	●	●	●	●	●	●	●	●	●	●	●	●	●	●
Callisto - Single and Double Wave	●	●	●	●	●	●	●	●	●	●	●	●	●	●	●	●
Callisto - 120 Degree	●	●	●	●	●	●	●	●	●	●	●	●	●	●	●	●
Callisto - Kidney, Radius Reception and Reception			●	●	●	●	●	●	●	●	●	●	●	●	●	●
Callisto - Linking			●	●	●	●	●	●	●	●	●	●	●	●	●	●
Callisto - Secretarial Return	●			●	●											
Windsor - Rectangular, Crescent, Single and Double Wave	●	●	●	●	●	●	●	●	●	●	●	●	●	●	●	●
Windsor - Bow Fronted Rectangular and Crescent			●	●	●	●	●	●	●	●	●	●	●	●	●	●
Windsor - Radius Reception			●	●	●	●	●	●	●	●	●	●	●	●	●	●
Windsor - Bow Fronted Reception				●	●											
Windsor - Radius Reception with Counter Tops						●										
Windsor - Secretarial Return				●	●											
Flexi - Rectangular, Crescent and Symmetrical Crescent	●	●	●	●	●	●	●	●	●	●	●	●	●	●	●	●
Flexi - Single and Double Wave and 120 Degree	●	●	●	●	●	●	●	●	●	●	●	●	●	●	●	●
Flexi - Secretarial Return	●			●	●											
Call Centre - Circular and Semi-circular	●					●										
Interact - Blade, Plectrum and Quad																
Reception - Connect				●	●	●	●	●	●	●	●	●	●	●	●	●
Reception - Windsor Bow Fronted Reception						●										
Benches - Alto Canopy	●					●										
Benches - Alto, Harmony and Loco	●					●										

Accessory Compatibility

- **Black** - Compatible
- **Orange** - Non-standard position required
- **Blue** - Conflict when using screens without .../V
- **Purple** - Conflict when using cable tray
- **Green** - Unspecified
- **Red** - May not support larger modules

	Kaspa, page 294	Prime, page 294	Boardroom, page 295	Conus, page 296	Peak, page 297	Escalate, page 297	Wireless Charging Unit, page 298	Port Hole, page 299	Pix, page 299	Pluto, page 300	Inca, page 300	Flex, page 301	Boost, page 301	Capsule, page 302	Plaza, page 303	Wieland Socket Boxes, page 303
Progress Plus - Double Benches							●	●	●			●	●	●	●	●
Progress Plus - Rectangular						●	●	●	●	●	●	●	●	●	●	●
Progress Plus - 120 Degree							●	●	●			●		●		●
Progress Plus - Conference / Meeting	●	●		●	●	●										
Progress - Double Benches							●	●	●			●		●		●
Progress - Rectangular						●	●	●	●	●	●	●	●	●	●	●
Progress - 120 Degree							●	●	●	●	●	●		●		●
Progress - Conference / Meeting	●	●				●	●	●	●	●	●					
Progress Lite - Double Benches							●	●	●	●	●	●		●		●
Linnea Elevate - Double Benches							●					●	●	●	●	●
Linnea Elevate - Rectangular												●	●	●	●	●
Lux - Double Benches						●	●	●	●			●		●		●
Lux - Rectangular	●	●				●	●	●	●	●	●	●	●	●	●	●
Lux - 1000w Circular Meeting	●	●	●	●	●	●	●	●	●	●	●	●	●	●	●	●
Lux - All other Conference / Meeting	●	●	●	●	●	●	●	●	●	●	●	●	●	●	●	●
Lux - Benches	●	●	●	●	●	●	●	●	●	●	●	●	●	●	●	●
Reflex - Rectangular and Managers						●	●	●	●	●	●	●	●	●	●	●
Reflex - 1000w Circular Meeting	●	●	●	●	●	●	●	●	●	●	●	●	●	●	●	●
Reflex - All other Conference / Meeting	●	●	●	●	●	●	●	●	●	●	●	●	●	●	●	●
Linnea - Double Benches							●					●	●	●	●	●
Linnea - Rectangular, Angular and Secretarial Return						●	●	●	●	●	●	●	●	●	●	●
Linnea - Radius Reception							●	●	●	●	●	●		●		●
Linnea - 120 Degree Cluster							●	●	●	●	●	●		●		●
Linnea - 2000, 1800 and 1600w and 800d Meeting	●	●	●	●	●			●	●	●	●					●
Linnea - 1400w and 800d Meeting	●	●	●	●	●			●	●	●	●					●
Linnea - 1000w Meeting	●	●	●	●	●	●	●	●	●	●	●	●	●	●	●	●
Linnea - All other Conference / Meeting	●	●	●	●	●	●	●	●	●	●	●	●	●	●	●	●
Matrix+ - Double Benches							●	●	●	●	●	●	●	●	●	●
Matrix+ - Rectangular and Angular	●	●				●	●	●	●	●	●	●	●	●	●	●
Matrix+ - 120 Degree							●	●	●	●	●	●	●	●	●	●
Matrix+ - Secretarial Return						●	●	●	●	●	●	●	●	●	●	●
Matrix+ - Conference / Meeting	●	●	●	●	●	●	●	●	●	●	●	●	●	●	●	●

Accessory Compatibility

- **Black** - Compatible
- **Orange** - Non-standard position required
- **Blue** - Conflict when using screens without .../V
- **Purple** - Conflict when using cable tray
- **Green** - Unspecified
- **Red** - May not support larger modules

	Power and Data Modules															
	Kaspa, page 294	Prime, page 294	Boardroom, page 295	Conus, page 296	Peak, page 297	Escalate, page 297	Wireless Charging Unit, page 298	Port Hole, page 299	Pix, page 299	Pluto, page 300	Inca, page 300	Flex, page 301	Boost, page 301	Capsule, page 302	Plaza, page 303	Wieland Socket Boxes, page 303
Kassini - Rectangular, 'D' Ended and Radius Executive	●	●				●	●	●	●	●	●	●	●	●	●	●
Kassini - Bow Fronted Rectangular and Crescent	●	●				●	●	●	●	●	●	●	●	●	●	●
Kassini - Crescent, Radius Crescent and Symmetrical Crescent	●	●				●	●	●	●	●	●	●	●	●	●	●
Kassini - Single and Double Wave	●	●				●	●	●	●	●	●	●	●	●	●	●
Kassini - 120 Degree	●	●				●	●	●	●	●	●	●	●	●	●	●
Kassini - Kidney, Radius Reception and Reception	●	●				●	●	●	●	●	●	●	●	●	●	●
Kassini - Linking	●	●				●	●	●	●	●	●	●	●	●	●	●
Kassini - Secretarial Return								●	●			●		●		
Optima Plus - Rectangular, 'D' Ended and Radius Executive	●	●				●	●	●	●	●	●	●	●	●	●	●
Optima Plus - Bow Fronted Rectangular and Crescent	●	●				●	●	●	●	●	●	●	●	●	●	●
Optima Plus - Crescent, Radius Crescent and Symmetrical Crescent	●	●				●	●	●	●	●	●	●	●	●	●	●
Optima Plus - Single and Double Wave	●	●				●	●	●	●	●	●	●	●	●	●	●
Optima Plus - 120 Degree	●	●				●	●	●	●	●	●	●	●	●	●	●
Optima Plus - Kidney, Radius Reception and Reception	●	●				●	●	●	●	●	●	●	●	●	●	●
Optima Plus - Linking	●	●				●	●	●	●	●	●	●	●	●	●	●
Optima Plus - Secretarial Return								●	●			●		●		
Optima Plus - Meeting / Conference	●	●	●	●	●	●	●	●	●	●	●	●	●	●	●	●
Callisto - Rectangular, 'D' Ended and Radius Executive	●	●				●	●	●	●	●	●	●	●	●	●	●
Callisto - Bow Fronted Rectangular and Crescent	●	●				●	●	●	●	●	●	●	●	●	●	●
Callisto - Crescent, Radius Crescent and Symmetrical Crescent	●	●				●	●	●	●	●	●	●	●	●	●	●
Callisto - Single and Double Wave	●	●				●	●	●	●	●	●	●	●	●	●	●
Callisto - 120 Degree	●	●				●	●	●	●	●	●	●	●	●	●	●
Callisto - Kidney, Radius Reception and Reception	●	●				●	●	●	●	●	●	●	●	●	●	●
Callisto - Linking	●	●				●	●	●	●	●	●	●	●	●	●	●
Callisto - Secretarial Return								●	●			●		●		
Callisto - Meeting / Conference	●	●	●	●	●	●	●	●	●	●	●	●	●	●	●	●
Windsor - Rectangular, Crescent, Single and Double Wave						●	●	●	●	●	●	●	●	●	●	●
Windsor - Bow Fronted Rectangular and Crescent						●	●	●	●	●	●	●	●	●	●	●
Windsor - Radius Reception						●	●	●	●	●	●	●	●	●	●	●
Windsor - Bow Fronted Reception						●	●	●	●	●	●	●	●	●	●	●
Windsor - Radius Reception with Counter Tops						●	●	●	●	●	●	●	●	●	●	●
Windsor - Secretarial Return						●	●	●	●	●	●	●	●	●	●	●
Windsor - Meeting / Conference	●	●	●	●	●	●	●	●	●	●	●	●	●	●	●	●
Flexi - Rectangular, Crescent and Symmetrical Crescent						●	●	●	●	●	●	●	●	●	●	●
Flexi - Single and Double Wave and 120 Degree						●	●	●	●	●	●	●	●	●	●	●
Flexi - Secretarial Return								●	●			●		●		
Flexi - Linking								●	●			●		●		

Accessory Compatibility

- **Black** - Compatible
- **Orange** - Non-standard position required
- **Blue** - Conflict when using screens without .../V
- **Purple** - Conflict when using cable tray
- **Green** - Unspecified
- **Red** - May not support larger modules

	Kaspa, page 294	Prime, page 294	Boardroom, page 295	Conus, page 296	Peak, page 297	Escalate, page 297	Wireless Charging Unit, page 298	Port Hole, page 299	Pix, page 299	Pluto, page 300	Inca, page 300	Flex, page 301	Boost, page 301	Capsule, page 302	Plaza, page 303	Wieland Socket Boxes, page 303
Call Centre - Circular and Semi-circular						●	●	●	●	●	●	●		●		●
Interact - Blade, Plectrum and Quad	●	●	●	●	●	●	●	●	●	●	●	●	●	●	●	●
Reception - Connect	●	●	●	●	●	●	●	●	●	●	●	●	●	●	●	●
Reception - Windsor Bow Fronted Reception						●	●	●	●	●	●					
Conference / Meeting - Aerofoil	●	●	●	●	●	●	●	●	●	●	●	●	●	●	●	●
Conference / Meeting - Qube 1200d	●	●	●	●	●	●	●	●	●	●	●	●	●	●	●	●
Conference / Meeting - Qube 1000d	●	●				●	●	●	●	●	●	●	●	●	●	●
Conference / Meeting - All other Qube	●	●	●	●	●	●	●	●	●	●	●	●	●	●	●	●
Benches - Alto Canopy	●	●	●	●	●	●	●	●	●	●	●	●	●	●	●	●
Benches - Alto 2200w	●	●	●	●	●	●	●	●	●	●	●	●	●	●	●	●
Benches - Alto 1200w	●	●	●	●	●	●	●	●	●	●	●	●	●	●	●	●
Benches - All other Alto	●	●	●	●	●	●	●	●	●	●	●	●	●	●	●	●
Benches - Harmony 2000w	●	●	●	●	●	●	●	●	●	●	●	●	●	●	●	●
Benches - All other Harmony	●	●	●	●	●	●	●	●	●	●	●	●	●	●	●	●
Benches - Loco	●	●	●	●	●	●	●	●	●	●	●	●	●	●	●	●
Benches - Cubeform	●	●	●	●	●	●	●	●	●	●	●	●	●	●	●	●
Benches - Forte	●	●	●	●	●	●	●	●	●	●	●	●	●	●	●	●
Benches - Lux	●	●	●	●	●	●	●	●	●	●	●	●	●	●	●	●
Modular Meeting - Fliptop Rectangular and Semi-circular	●	●	●	●	●	●	●	●	●	●	●	●	●	●	●	●
Modular Meeting - Fliptop Circular												●	●	●	●	●
Modular Meeting - Folding							●			●	●	●	●	●	●	●
Modular Meeting - Training	●	●	●	●	●	●	●	●	●	●	●	●	●	●	●	●
Modular Meeting - Vista	●	●					●	●	●	●	●	●	●	●	●	●
Modular Meeting - Piazza and Piazza	●	●	●	●	●	●	●	●	●	●	●	●	●	●	●	●
Modular Meeting - Meeting MT01							●	●	●	●	●	●	●	●	●	●
Modular Meeting - Meeting MT13	●	●	●	●	●	●	●	●	●	●	●	●	●	●	●	●
Modular Meeting - Meeting All Others												●	●	●	●	●
Modular Meeting - Bar												●	●	●	●	●
Modular Meeting - Coffee ESC, ELL, EVOP, CCT750L, SCT800 and TCT900	●	●	●	●	●	●	●	●	●	●	●	●	●	●	●	●
Modular Meeting - Coffee Cubeform	●	●	●	●	●	●	●	●	●	●	●	●	●	●	●	●
Modular Meeting - Coffee All Others												●	●	●	●	●
Modular Meeting - TV	●	●	●	●	●	●	●	●	●	●	●	●	●	●	●	●
Modular Meeting - Laptop												●	●	●	●	●
Modular Meeting - Whiteboard																●

Dimensions

DESKING

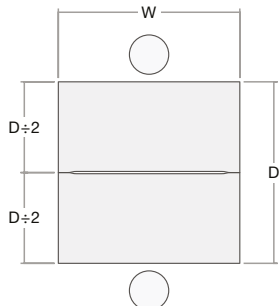

Double Bench: $W \times D \times H$
Available on Progress Plus, Progress, Progress Lite, Linnea Elevate, Linnea and Matrix+

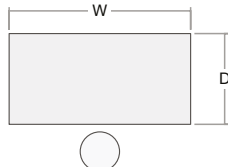

Rectangular: $W \times D \times H$
Available on Progress Plus, Progress, Linnea Elevate, Lux, Reflex, Linnea, Matrix+, Kassini, Optima Plus, Callisto, Windsor and Flexi

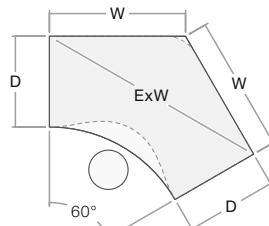

120 Degree: $ExW (W \times D) \times H$
Available on, Matrix+, Kassini, Optima Plus, Callisto and Flexi

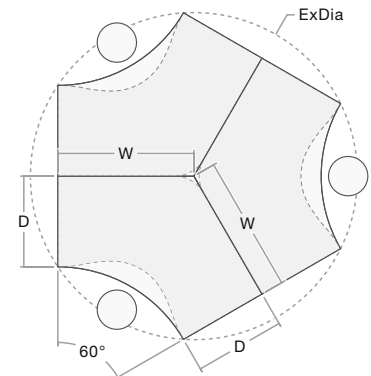

120 Degree Cluster: $ExDia (W \times D) \times H$
Available on Progress Plus, Progress and Linnea

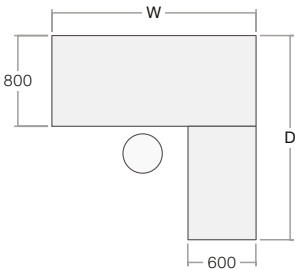

Managers: $W \times D \times H$
Available on Reflex and Matrix+

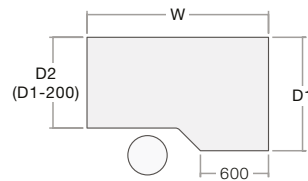

Angular: $W \times D1 (D2) \times H$
Available on Linnea and Matrix+

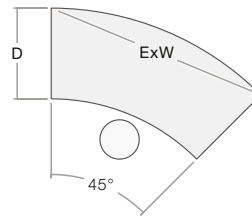

Radius Reception: $ExW \times D \times H$
Available on Linnea, Kassini, Optima Plus and Callisto

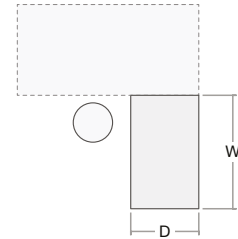

Secretarial Return: $W \times D \times H$
Available on Linnea, Matrix+, Kassini, Optima Plus, Windsor and Flexi

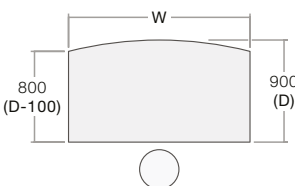

Bow Fronted Rectangular: $W \times D \times H$
Available on Kassini, Optima Plus, Callisto and Windsor

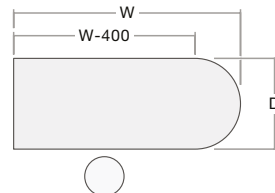

'D' Ended Rectangular: $W \times D \times H$
Available on Kassini, Optima Plus and Callisto

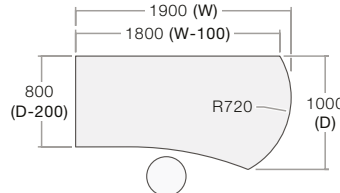

Radius Executive Rectangular: $W \times D \times H$
Available on Kassini, Optima Plus and Callisto

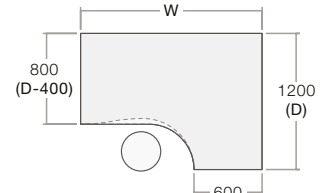

Crescent: $W \times D \times H$
Available on Kassini, Optima Plus, Callisto, Windsor and Flexi

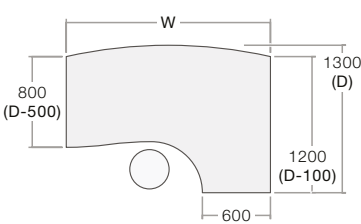

Bow Fronted Crescent: $W \times D \times H$
Available on Kassini, Optima Plus, Callisto and Windsor

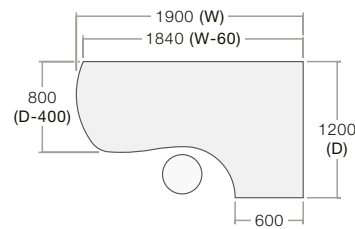

Radius Executive Crescent: $W \times D \times H$
Available on Kassini, Optima Plus and Callisto

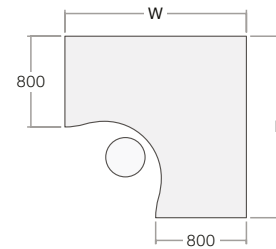

Symmetrical Crescent: $W \times D \times H$
Available on Kassini, Optima Plus, Callisto and Flexi

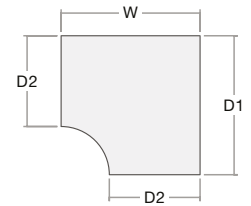

Linking: $W \times D1 (D2) \times H$
Available on Kassini, Optima Plus and Flexi

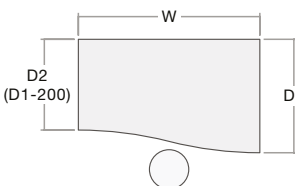

Single Wave: $W \times D1/D2 \times H$
Available on Kassini, Optima Plus, Callisto, Windsor and Flexi

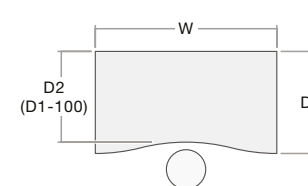

Double Wave: $W \times D1/D2 \times H$
Available on Kassini, Optima Plus, Callisto, Windsor and Flexi

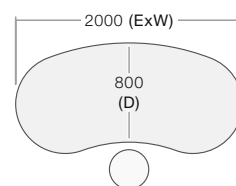

Kidney: $ExW \times D \times H$
Available on Kassini, Optima Plus and Callisto

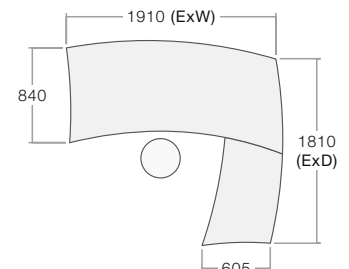

Reception: $ExW \times ExD \times H$
Available on Kassini, Optima Plus and Callisto

Dimensions

DESKING

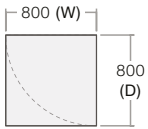

Linking: W x D x H
Available on Optima Plus Only

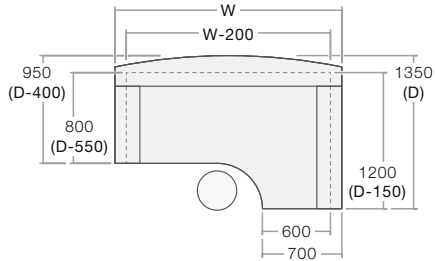

Windsor Bow Fronted Reception: W x D x H
Available on Windsor Only

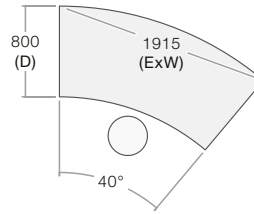

Windsor Radius Reception: ExW x D x H
Available on Windsor Only

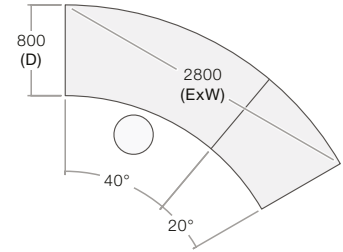

Windsor Radius Reception with Accessibility Extension: ExW x D x H
Available on Windsor Only

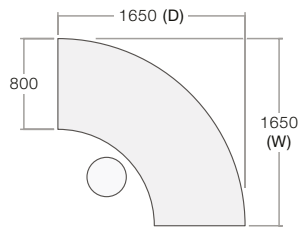

Connect Curved Reception: W x D x H
Available on Connect Only

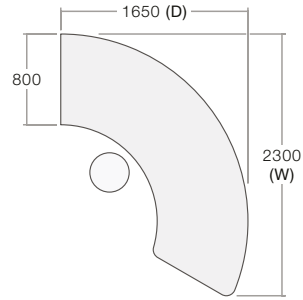

Connect Curved Reception with Accessibility Extension: W x D1 (D2) x H
Available on Connect Only

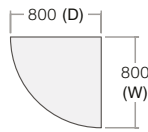

Connect Corner Reception: W x D x H
Available on Connect Only

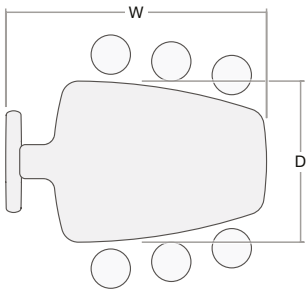

Interact Blade: W x D x H
Available on Interact Only

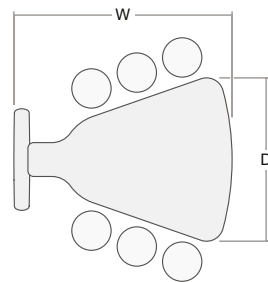

Interact Plectrum: W x D x H
Available on Interact Only

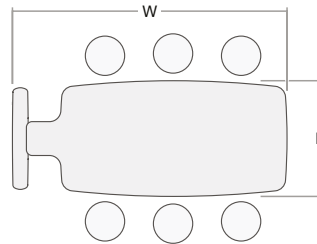

Interact Quad: W x D x H
Available on Interact Only

MODULAR TABLES

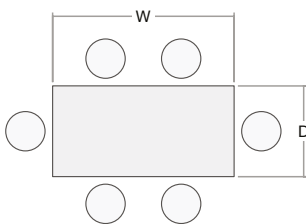

Rectangular: W x D x H

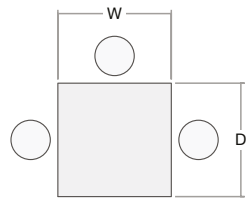

Square: W x D x H

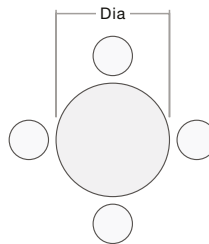

Circular: Dia x H

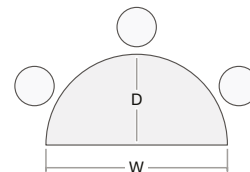

Semi-Circular: W x D x H

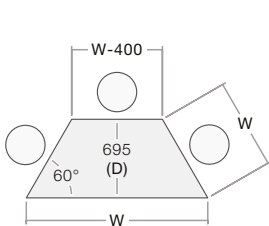

Trapezoidal: W x D x H

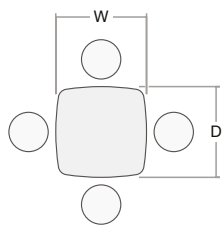

Squircle: W x D x H

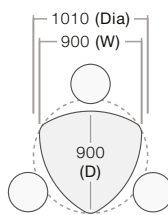

Triangular: Dia (W x D) x H

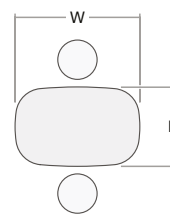

Rounded Rectangular: W x D x H

The dimensions illustrated in this document are not to scale. For accurate dimensions of any Elite product, please contact customer services.

Dimensions

CONFERENCE TABLES

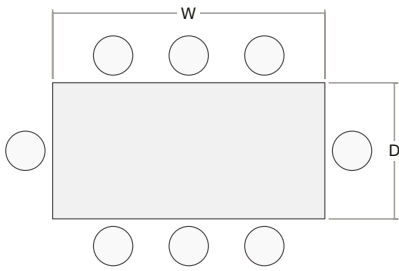

Rectangular: W x D x H

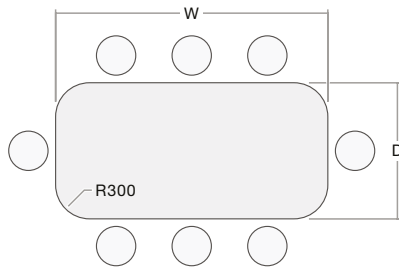

Double 'D' Ended Rectangular: W x D x H

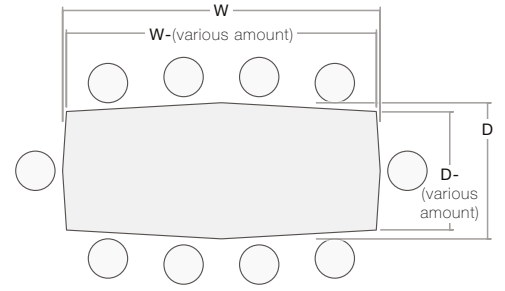

Octagonal: W x D x H

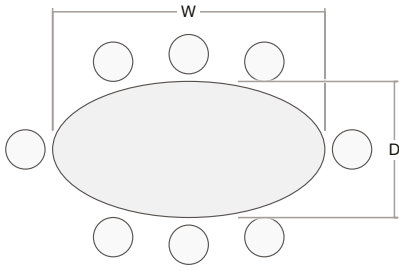

Oval: W x D x H

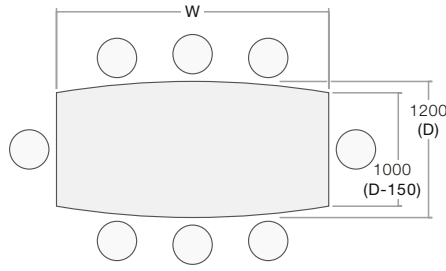

Windsor Barrel: W x D x H

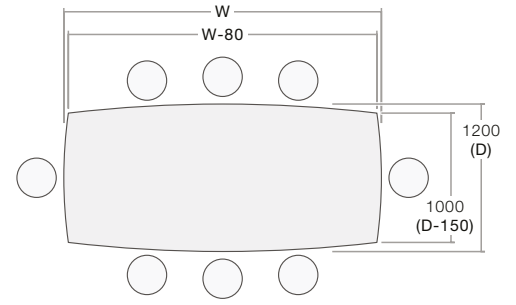

Aerofoil Barrel: W x D x H

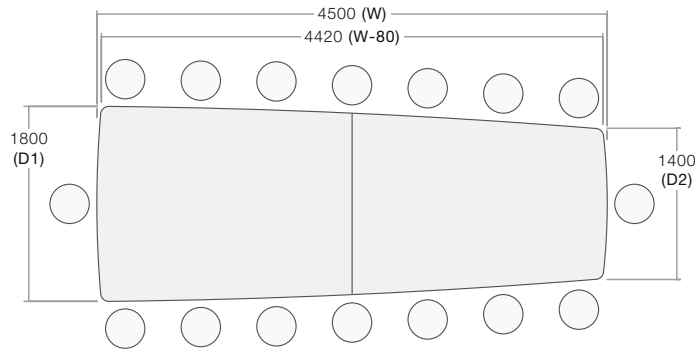

Progress Plus Half-Barrel: W x D1-D2 x H

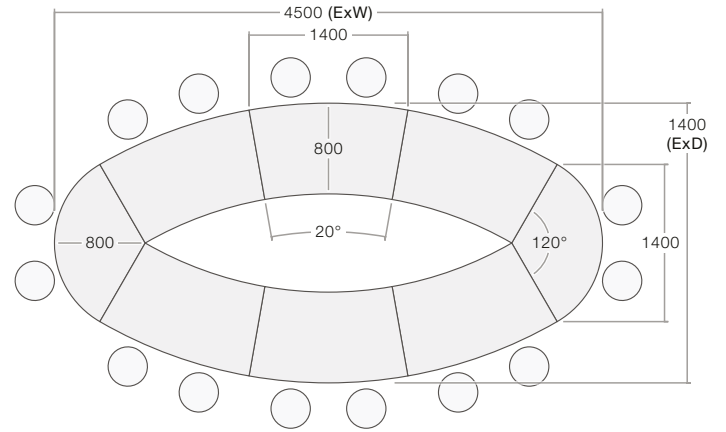

Callisto Segue: W x D x H

MEETING TABLES

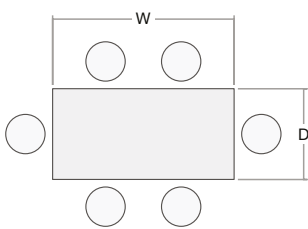

Rectangular: W x D x H

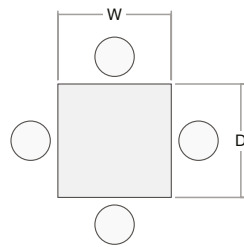

Square: W x D x H

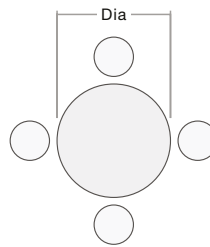

Circular: Dia x H

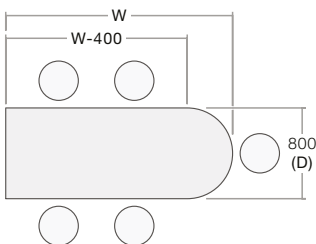

'D' Ended Rectangular: W x D x H

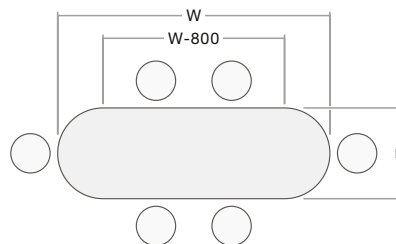

Double 'D' Ended Rectangular: W x D x H

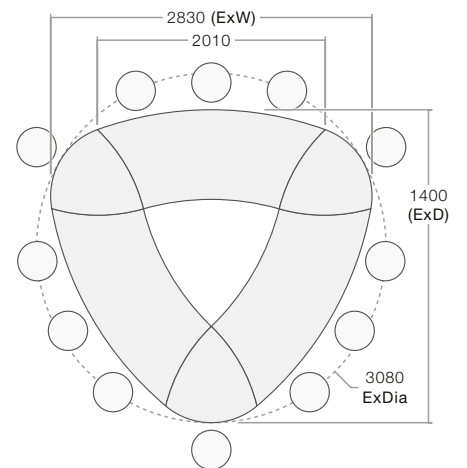

Callisto Segue: ExDia (ExW x ExD) x H

The dimensions illustrated in this document are not to scale. For accurate dimensions of any Elite product, please contact customer services.

Terms and Conditions

INTERPRETATION

- In these Conditions, the following definitions apply:
"Business Day" means a day (other than a Saturday, Sunday or public holiday) when banks in London are open for business;
"Conditions" means the terms and conditions set out in this document as amended from time to time in accordance with clause 52;
"Contract" means the contract between EOF and the Customer for the sale and purchase of the Goods in accordance with these Conditions;
"Customer" means the person or firm who purchases the Goods from EOF;
"EOF" means Elite Office Furniture (UK) Ltd, a company incorporated in England and Wales with company number 03365655;
"Force Majeure Event" means has the meaning given in clause 46;
"Goods" means the goods (or any part of them) set out in the Order;
"Order" means the Customer's order for the Goods, as set out [in the Customer's purchase order form OR overleaf OR in the Customer's written acceptance of the EOF's quotation OR in the Customer's purchase order form, the Customer's written acceptance of EOF's quotation]
"Specials" means any bespoke products manufactured or otherwise supplied by EOF to the Customer's Specification; and
"Specification" means any specification for the Goods agreed between the parties in accordance with clause 9.
- In these Conditions:
 - a person includes a natural person, corporate or unincorporated body (whether or not having separate legal personality);
 - a reference to a party includes its personal representatives, successors or permitted assigns;
 - a reference to a statute or statutory provision is a reference to such statute or provision as amended or re-enacted. A reference to a statute or statutory provision includes any subordinate legislation made under that statute or statutory provision, as amended or re-enacted;
 - any phrase introduced by the terms including, include, in particular or any similar expression shall be construed as illustrative and shall not limit the sense of the words preceding those terms; and
 - a reference to writing or written includes faxes and e-mails.

BASIS OF THE CONTRACT

- These Conditions apply to the Contract to the exclusion of any other terms that the Customer seeks to impose or incorporate, or which are implied by trade, custom, practice or course of dealing. The Order constitutes an offer by the Customer to purchase the Goods in accordance with these Conditions.
- The Order shall only be deemed to be accepted when EOF issues a written acceptance of the Order, at which point the Contract shall come into existence. The Customer is responsible for ensuring that the terms of the Order and any applicable Specification are complete and accurate. The Customer must communicate any errors to EOF's Customer Services Team within 12 hours (and confirmed in writing within 24 hours) and accepts that failure to do will render them liable for potential abortive costs.
- The Contract constitutes the entire agreement between the parties. The Customer acknowledges that it has not relied on any statement, promise or representation made or given by or on behalf of EOF which is not set out in the Contract.
- Any samples, drawings, descriptive matter, or advertising produced by EOF and any descriptions or illustrations contained in EOF's catalogues, brochures and website are produced for the sole purpose of giving an approximate idea of the Goods described in them. They shall not form part of the Contract or have any contractual force.
- A quotation for the Goods given by EOF shall not constitute an offer. A quotation shall only be valid for a period of 30 Business Days from its date of issue.

PRODUCTS

- The Goods are, subject to clause 6, as described in EOF's catalogue as modified by any applicable Specification.
- Requests for Special product(s) must be submitted on the official 'Elite Specials Request Form' which is available via the Elite web site or on request from EOF's Customer Services Department. When submitted the document will be processed by the Elite Specials team and a decision will be made either to accept or reject the request based on its validity and feasibility. It is EOF's aim to return completed forms within 2 – 3 Business Days.
- To the extent that the Goods are to be manufactured in accordance with a Specification supplied by the Customer, the Customer shall indemnify EOF against all liabilities, costs, expenses, damages and losses (including any direct, indirect or consequential losses, loss of profit, loss of reputation and all interest, penalties and legal and other professional costs and expenses) suffered or incurred by EOF in connection with any claim made against EOF for actual or alleged infringement of a third party's intellectual property rights arising out of or in connection with EOF's use of the Specification. This clause 10 shall survive termination of the Contract.

- EOF reserves the right to discontinue the manufacture or supply of the Goods or amend the specification of the Goods without notice:
 - if required by any applicable statutory or regulatory requirements; or
 - in accordance with its policy of continuous product development.

CANCELLATIONS AND VARIATIONS

- It is in EOF's sole discretion, having regard to any agreed delivery dates, when to commence manufacture of the Goods. Cancellations must be communicated to EOF in writing. Cancellations received by EOF:
 - prior to manufacture may, in EOF's sole discretion, be subject to a 25% administration cost (such cost being a genuine pre-estimate of the cost of, amongst other things, the rescheduling of production runs);
 - following commencement of manufacture will be charged in full;
 - in respect of outsourced Goods (i.e. not manufactured by EOF) shall be subject to a 25% administration cost (such cost being a genuine pre-estimate of EOF cancelling its order with any third party supplier), please note that whilst EOF may, but shall be under no obligation so to do, have regard to the stage of production reached when receiving the Customer's notice of cancellation when determining cancellation costs it reserves the right to charge for cancellations in full. Specials shall always be charged in full.
- If the Customer wishes to change anything in the Contract, the request must be made in writing. EOF will inform the Customer whether it is willing to agree to the change and, if so, what will be the impact on the price and delivery date. The Customer must notify EOF in writing within 2 days of receiving EOF's response whether these changes are accepted and if so, the Contract will be deemed to have been varied accordingly. EOF will not proceed with the change until this notice is received. A request to reduce the quantity of Goods ordered will not result in a price reduction unless otherwise agreed in writing by EOF.

DELIVERY

- EOF shall ensure that:
 - each delivery of the Goods is accompanied by a delivery note which shows the date of the Order, all relevant Customer and EOF reference numbers, the type and quantity of the Goods (including the code number of the Goods, where applicable), special storage instructions (if any) and, if the Order is being delivered by instalments, the outstanding balance of Goods remaining to be delivered; and
 - if EOF requires the Customer to return any packaging materials to EOF, that fact is clearly stated on the delivery note. The Customer shall make any such packaging materials available for collection at such times as EOF shall reasonably request. Returns of packaging materials shall be at EOF's expense.
- EOF shall deliver the Goods to the location set out in the Order (one address only) or such other location as the parties may agree ("Delivery Location") at any time after EOF notifies the Customer that the Goods are ready. Delivery requests for alternative addresses will be charged at a minimum amount and must be approved by EOF's Customer Services Team prior to placing the Order. EOF reserves the right to decline any such request.
- Delivery of the Goods shall be completed on the Goods' arrival at the Delivery Location and in the case of ex-works on EOF notifying the Customer that the Goods are ready for collection. All deliveries must be signed for & appropriately dated. Items cannot be signed unchecked, it is the Customer's responsibility to visually check items delivered and investigate items where the packaging is visibly damaged or torn. Deliveries are inclusive of tailboard only where it is the Customer's responsibility to provide free assistance in unloading the vehicle. Once unloaded to the tailboard of the vehicle and handed to the Customer, it is their responsibility from here on. Notification of shortages and/or damages must be made in writing to EOF within 3 days of delivery.
- Any dates quoted for delivery are approximate only, and the time of delivery is not of the essence. EOF shall not be liable for any delay in delivery of the Goods that is caused by a Force Majeure Event or the Customer's failure to provide EOF with adequate delivery instructions or any other instructions that are relevant to the supply of the Goods. EOF deliver on multi-drop vehicles and no guarantee can be made to set timescales. However, if the volume permits a dedicated delivery can be made (subject to additional costs) and an estimated time of delivery can be requested. In such cases EOF will not be liable for financial penalties resulting in late delivery of products.
- EOF shall have no liability for any failure to deliver the Goods to the extent that such failure is caused by a Force Majeure Event or the Customer's failure to provide EOF with adequate delivery instructions or any other instructions that are relevant to the supply of the Goods.

- If the Customer fails to take delivery of the Goods within 3 Business Days of EOF notifying the Customer that the Goods are ready, then, except where such failure or delay is caused by a Force Majeure Event or EOF's failure to comply with its obligations under the Contract:
 - delivery of the Goods shall be deemed to have been completed at 9.00 am on the third Business Day after the day on which EOF notified the Customer that the Goods were ready; and
 - EOF shall store the Goods until delivery takes place, and charge the Customer for all related costs and expenses (including insurance, storage and redelivery).
- If 10 Business Days after the day on which EOF notified the Customer that the Goods were ready for delivery the Customer has not taken delivery of them, EOF may resell or otherwise dispose of part or all of the Goods and, after deducting reasonable storage and selling costs, account to the Customer for any excess over the price of the Goods paid by the Customer or charge the Customer for any shortfall below the price of the Goods.
- EOF may deliver the Goods by instalments, which shall be invoiced and paid for separately. Each instalment shall constitute a separate Contract. Any delay in delivery or defect in an instalment shall not entitle the Customer to cancel any other instalment.

QUALITY/RETURNS

- EOF warrants that on delivery, and for a period of 5 years from the date of delivery ("Warranty Period"), the Goods shall:
 - conform in all material respects with their description and any applicable Specification;
 - be free from material defects in design, material and workmanship; and
 - be of satisfactory quality (within the meaning of the Sale of Goods Act 1979); and
 - be fit for any purpose held out by EOF.
- Subject to clause 24 if:
 - the Customer gives notice in writing to EOF during the Warranty Period within a reasonable time of discovery that some or all of the Goods do not comply with the warranty set out in clause 22;
 - EOF is given a reasonable opportunity of examining such Goods; and
 - the Customer (if asked to do so by EOF) returns such Goods to EOF's place of business at EOF's cost, EOF shall, at its option, repair or replace the defective Goods, or refund the price of the defective Goods in full.
- EOF shall not be liable for the Goods' failure to comply with the warranty set out in clause 22 in any of the following events:
 - the Customer makes any further use of such Goods after giving notice in accordance with clause 22;
 - the defect arises because the Customer failed to follow EOF's oral or written instructions as to the storage, commissioning, installation, use and maintenance of the Goods or (if there are none) good trade practice regarding the same;
 - the defect arises as a result of EOF following any drawing, design or Specification supplied by the Customer;
 - the Customer alters or repairs such Goods without EOF's prior written consent;
 - the defect arises as a result of fair wear and tear, wilful damage, negligence, or abnormal storage or working conditions; or
 - the Goods differ from their description or, as the case may be, the Specification as a result of changes made to ensure they comply with applicable statutory or regulatory requirements.
- Wood veneers vary in grain and colour, EOF do not book match veneers and work with pre-veneered boards limiting the matching of veneers on adjoining surfaces. EOF will not be liable whatsoever for any variation and shall be under no obligation to accept return of Goods where a variation occurs. Veneer is a natural material and variations on pre-veneered board are inevitable. If the Customer requires book matching on veneers a specialist supplier should be identified and appointed.
- Except as provided in clauses 22 to 26 (inclusive), EOF shall have no liability to the Customer in respect of the Goods' failure to comply with the warranty set out in clause 22.
- Except as set out in these Conditions, all warranties, conditions and other terms implied by statute or common law are, to the fullest extent permitted by law, excluded from the Contract.
- These Conditions shall apply to any repaired or replacement Goods supplied by EOF.

Terms and Conditions

TITLE AND RISK

29. The risk in the Goods shall pass to the Customer on completion of delivery.
30. Title to the Goods shall not pass to the Customer until EOF has received payment in full (in cash or cleared funds) for:
- 30.1 the Goods; and
- 30.2 any other goods or services that EOF has supplied to the Customer.
31. Until title to the Goods has passed to the Customer, the Customer shall:
- 31.1 hold the Goods on a fiduciary basis as EOF's bailee;
- 31.2 store the Goods separately from all other goods held by the Customer so that they remain readily identifiable as EOF's property;
- 31.3 not remove, deface or obscure any identifying mark or packaging on or relating to the Goods;
- 31.4 maintain the Goods in satisfactory condition and keep them insured against all risks for their full price from the date of delivery;
- 31.5 notify EOF immediately if it becomes subject to any of the events listed in clause 43; and
- 31.6 give EOF such information relating to the Goods as EOF may require from time to time, but the Customer may resell or use the Goods in the ordinary course of its business.
32. If before title to the Goods passes to the Customer the Customer becomes subject to any of the events listed in clause 43, or EOF reasonably believes that any such event is about to happen and notifies the Customer accordingly, then, provided that the Goods have not been resold, or irrevocably incorporated into another product, and without limiting any other right or remedy EOF may have, EOF may at any time require the Customer to deliver up the Goods and, if the Customer fails to do so promptly, enter any premises of the Customer or of any third party where the Goods are stored in order to recover them.

FINANCIAL - PRICES

33. The price of the Goods shall be the price set out in the Order, or, if no price is quoted, the price set out in EOF's published price list in force as at the date of delivery.
34. EOF may, by giving notice to the Customer at any time before delivery, increase the price of the Goods to reflect any increase in the cost of the Goods that is due to:
- 34.1 any factor beyond EOF's reasonable control (including foreign exchange fluctuations, increases in taxes and duties, and increases in labour, materials and other manufacturing costs);
- 34.2 any request by the Customer to change the delivery date(s), quantities or types of Goods ordered, or the Specification; or
- 34.3 any delay caused by any instructions of the Customer or failure of the Customer to give EOF adequate or accurate information or instructions.
35. The price of the Goods is inclusive of the costs and charges of packaging. (Export product will be subject to additional charges, please contact the Elite Customer Services for prices).
36. The price of the Goods is exclusive of amounts in respect of value added tax ("VAT"). The Customer shall, on receipt of a valid VAT invoice from EOF, pay to EOF such additional amounts in respect of VAT as are chargeable on the supply of the Goods.

FINANCIAL - PAYMENT

37. EOF requires 2 bank references for new account applications and reserves the right to change its financial requirements as and when it deems it appropriate.
38. EOF may invoice the Customer for the Goods on or at any time after the completion of delivery.
39. The Customer shall pay the invoice in full and in cleared funds by the end of the month following the month the invoice was dated. Time of payment is of the essence.
40. If the Customer fails to make any payment due to EOF under the Contract by the due date for payment ("due date"), then the Customer shall pay interest on the overdue amount at the rate of 2.5% per annum above [HSBC]'s base rate from time to time. Such interest shall accrue on a daily basis from the due date until the date of actual payment of the overdue amount, whether before or after judgment. The Customer shall pay the interest together with the overdue amount. EOF reserves the right to charge interest on any overdue payment in accordance with the Late Payment of Commercial Debts (Interest) Act 1998. The Customer shall be liable for all reasonable costs (including legal and court costs) associated with the collection of overdue accounts.

41. The Customer shall pay all amounts due under the Contract in full without any deduction or withholding except as required by law and the Customer shall not be entitled to assert any credit, set-off or counterclaim against EOF in order to justify withholding payment of any such amount in whole or in part. EOF may at any time, without limiting any other rights or remedies it may have, set off any amount owing to it by the Customer against any amount payable by EOF to the Customer.

CUSTOMER'S INSOLVENCY OR INCAPACITY

42. If the Customer becomes subject to any of the events listed in clause 43, or EOF reasonably believes that the Customer is about to become subject to any of them and notifies the Customer accordingly, then, without limiting any other right or remedy available to EOF, EOF may cancel or suspend all further deliveries under the Contract or under any other contract between the Customer and EOF without incurring any liability to the Customer, and all outstanding sums in respect of Goods delivered to the Customer shall become immediately due.
43. For the purposes of clause 42, the relevant events are:
- 43.1 the Customer suspends, or threatens to suspend, payment of its debts, or is unable to pay its debts as they fall due or admits inability to pay its debts, or (being a company) is deemed unable to pay its debts within the meaning of section 123 of the Insolvency Act 1986, or (being an individual) is deemed either unable to pay its debts or as having no reasonable prospect of so doing, in either case, within the meaning of section 268 of the Insolvency Act 1986, or (being a partnership) has any partner to whom any of the foregoing apply;
- 43.2 the Customer commences negotiations with all or any class of its creditors with a view to rescheduling any of its debts, or makes a proposal for or enters into any compromise or arrangement with its creditors other than (where the Customer is a company) where these events take place for the sole purpose of a scheme for a solvent amalgamation of the Customer with one or more other companies or the solvent reconstruction of the Customer;
- 43.3 (being a company) a petition is filed, a notice is given, a resolution is passed, or an order is made, for or in connection with the winding up of the Customer, other than for the sole purpose of a scheme for a solvent amalgamation of the Customer with one or more other companies or the solvent reconstruction of the Customer;
- 43.4 (being an individual) the Customer is the subject of a bankruptcy petition or order;
- 43.5 a creditor or encumbrancer of the Customer attaches or takes possession of, or a distress, execution, sequestration or other such process is levied or enforced on or sued against, the whole or any part of its assets and such attachment or process is not discharged within 14 days;
- 43.6 (being a company) an application is made to court, or an order is made, for the appointment of an administrator or if a notice of intention to appoint an administrator is given or if an administrator is appointed over the Customer;
- 43.7 (being a company) a floating charge holder over the Customer's assets has become entitled to appoint or has appointed an administrative receiver;
- 43.8 a person becomes entitled to appoint a receiver over the Customer's assets or a receiver is appointed over the Customer's assets;
- 43.9 any event occurs, or proceeding is taken, with respect to the Customer in any jurisdiction to which it is subject that has an effect equivalent or similar to any of the events mentioned in clause 43.1 to clause 43.8 (inclusive);
- 43.10 the Customer suspends, threatens to suspend, ceases or threatens to cease to carry on all or substantially the whole of its business;
- 43.11 the Customer's financial position deteriorates to such an extent that in EOF's opinion the Customer's capability to adequately fulfil its obligations under the Contract has been placed in jeopardy; and
- 43.12 (being an individual) the Customer dies or, by reason of illness or incapacity (whether mental or physical), is incapable of managing his or her own affairs or becomes a patient under any mental health legislation.
- 43.13 Termination of the Contract, however arising, shall not affect any of the parties' rights and remedies that have accrued as at termination. Clauses which expressly or by implication survive termination of the Contract shall continue in full force and effect.
- ## LIMITATION OF LIABILITY
44. Nothing in these Conditions shall limit or exclude EOF's liability for:
- 44.1 death or personal injury caused by its negligence, or the negligence of its employees, agents or subcontractors (as applicable);
- 44.2 fraud or fraudulent misrepresentation;

- 44.3 breach of the terms implied by section 12 of the Sale of Goods Act 1979;
- 44.4 defective products under the Consumer Protection Act 1987; or
- 44.5 any matter in respect of which it would be unlawful for the EOF to exclude or restrict liability.
45. Subject to clause 44:
- 45.1 EOF shall under no circumstances whatever be liable to the Customer, whether in contract, tort (including negligence), breach of statutory duty, or otherwise, for any loss of profit, or any indirect or consequential loss arising under or in connection with the Contract; and
- 45.2 EOF's total liability to the Customer in respect of all other losses arising under or in connection with the Contract, whether in contract, tort (including negligence), breach of statutory duty, or otherwise, shall in no circumstances exceed the price of the Goods.

FORCE MAJEURE

46. EOF shall not be liable for any failure or delay in performing its obligations under the Contract to the extent that such failure or delay is caused by a Force Majeure Event. A Force Majeure Event means any event beyond a party's reasonable control, which by its nature could not have been foreseen, or, if it could have been foreseen, was unavoidable, including strikes, lock-outs or other industrial disputes (whether involving its own workforce or a third party's), failure of energy sources or transport network, acts of God, war, terrorism, riot, civil commotion, interference by civil or military authorities, national or international calamity, armed conflict, malicious damage, breakdown of plant or machinery, nuclear, chemical or biological contamination, sonic boom, explosions, collapse of building structures, fires, floods, storms, earthquakes, loss at sea, epidemics or similar events, natural disasters or extreme adverse weather conditions, or default of suppliers or subcontractors. If the event of force majeure continues for a continuous period in excess of 43 months, the Customer shall be entitled to give notice in writing to EOF to terminate the Contract.

GENERAL

47. EOF may at any time assign, transfer, charge, subcontract or deal in any other manner with all or any of its rights or obligations under the Contract.
48. The Customer may not assign, transfer, charge, subcontract or deal in any other manner with all or any of its rights or obligations under the Contract without EOF's prior written consent.
49. Any notice or other communication given to a party under or in connection with the Contract shall be in writing, addressed to that party at its registered office (if it is a company) or its principal place of business (in any other case) or such other address as that party may have specified to the other party in writing in accordance with this clause, and shall be delivered personally, sent by pre-paid first class post, recorded delivery, commercial courier, fax or e-mail.
50. A notice or other communication shall be deemed to have been received: if delivered personally, when left at the address referred to in clause 49; if sent by pre-paid first class post or recorded delivery, at 9.00 am on the second Business Day after posting; if delivered by commercial courier, on the date and at the time that the courier's delivery receipt is signed; or, if sent by fax or e-mail, one Business Day after transmission.
51. The provisions of clauses 49 and 50 shall not apply to the service of any proceedings or other documents in any legal action.
52. If any court or competent authority finds that any provision of the Contract (or part of any provision) is invalid, illegal or unenforceable, that provision or part-provision shall, to the extent required, be deemed to be deleted, and the validity and enforceability of the other provisions of the Contract shall not be affected.
53. If any invalid, unenforceable or illegal provision of the Contract would be valid, enforceable and legal if some part of it were deleted, the provision shall apply with the minimum modification necessary to make it legal, valid and enforceable.
54. A waiver of any right or remedy under the Contract is only effective if given in writing and shall not be deemed a waiver of any subsequent breach or default. No failure or delay by a party to exercise any right or remedy provided under the Contract or by law shall constitute a waiver of that or any other right or remedy, nor shall it preclude or restrict the further exercise of that or any other right or remedy. No single or partial exercise of such right or remedy shall preclude or restrict the further exercise of that or any other right or remedy.
55. A person who is not a party to the Contract shall not have any rights under or in connection with it.
56. Except as set out in these Conditions, any variation to the Contract, including the introduction of any additional terms and conditions, shall only be binding when agreed in writing and signed by EOF.
57. The Contract, and any dispute or claim arising out of or in connection with it or its subject matter or formation (including non-contractual disputes or claims), shall be governed by, and construed in accordance with, English law, and the parties irrevocably submit to the exclusive jurisdiction of the courts of England and Wales.

